

# IRWIN<sup>®</sup>

TOOLS

# CATALOGUE

2017



WISE-GRIP<sup>®</sup>

JACK

QUICK-GRIP<sup>®</sup>

Record<sup>®</sup>

Marples<sup>®</sup>

joran<sup>®</sup>

[www.irwin.eu](http://www.irwin.eu)



# INNOVATION MILESTONES

**1885**  
Patent of  
IRWIN® Auger  
Charles Irwin formed  
the IRWIN® Auger  
Bit Co

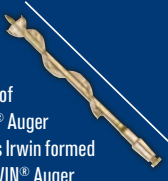

**1828**  
MARPLES®  
Chisels

**1890**  
Solid Center  
Auger



**1914**  
HANSON®  
Taps & Dies



**1924**  
WISE-GRIP®  
Locking Pliers



**1954**  
SPEEDBOR®  
Wood Boring  
Spade Bits



**1972**  
UNIBIT®  
Step Drill Bits



**2004**  
Bi-Metal Blades



**2006**  
Blue Groove 6X  
Wood Boring Bits



**2009**  
QUICK-GRIP®  
Bar Clamps



**2011**  
WISE-GRIP®  
Groovelock  
Water Pump Pliers



**2012**  
WISE-GRIP®  
Fast Release  
MARPLES®  
Chisels



**2014**  
JACK®  
Plus  
Handsaw Range  
MARPLES®  
& WELDTEC  
Circular Saw Blades



**2015**  
IMPACT  
Screwdriving Bits  
WISE-GRIP®  
Performance Pliers



**2016**  
RECORD®  
Quick-Adjusting Vice



## THE HISTORY OF IRWIN TOOLS

IRWIN Tools has a long and storied history, stretching for more than a century and set against the backdrop of a young, ambitious nation.

In 1885, Charles Irwin patented the Auger bit and, along with four business partners, formed the IRWIN Auger Bit Company. In 1924, William Petersen, a Danish immigrant, invented and patented VISE-GRIP® Locking Pliers. Through innovation and a series of acquisitions, these two companies have now become IRWIN Tools.

IRWIN Tools manufactures and distributes a broad line of hand tools and power tool accessories including JACK® handsaws, RECORD® clamping and locking tools, VISE-GRIP® pliers and wrenches, JORAN® drill bits, QUICK-GRIP® clamping tools, MARPLES® chisels and woodworking tools, and UNIBIT® drill bits.



## IRWIN® innovation

Innovation is the hallmark of IRWIN®. For more than 100 years, it's been an idea that has permeated the culture of our company, and it continues to drive everything we do. Beginning in 1885 with development of the first IRWIN® auger bit, and progressing with the introduction of Vise-Grip® locking tools, Blue Groove flat bits, and Quick-Grip® bar clamps, IRWIN® has been at the forefront of the industry, creating better tools in a better way. Our impressive track record of new product development is born from our passion for understanding the needs of our primary user – the professional tradesman. This dedication to improving products begins in the field, where IRWIN®'s specialised end-user teams visit construction sites. There, the IRWIN® Field Product Specialist team learns first-hand – from the professional – how to improve our products, and how to make the pro's job easier and more productive. This hard-earned knowledge is the foundation for a unique product development process utilised by IRWIN®'s engineering, marketing, and manufacturing teams to deliver a continuous stream of new products to the marketplace. Supported by a global network of world-class manufacturing facilities and bolstered by our partnerships with leading global retailers, IRWIN® continuously sets the professional standard in each and every market segment in which we compete. From product feedback and development to distribution and use in the field, we dedicate ourselves to delivering quality tools that meet the stringent requirements of our toughest critics – professional tradesmen.





# IRWIN® university

IRWIN® is committed to the pursuit of developing tools to get the job done right. Our commitment extends beyond our broad assortment of innovative IRWIN® products to include the development of our employees and valued customers. We are dedicated to delivering best-in-class career and industry development opportunities through a variety of product training programs.

## INSTRUCTOR-LED PRODUCT TRAINING

The IRWIN® University is a state-of-the-art facility dedicated to IRWIN® product development and training. IRWIN® employees participate in a variety of multi-day training programs led by highly skilled facilitators to expand their knowledge of IRWIN® hand tools and power tool accessories. These hands-on courses range from introductory product knowledge overviews to more advanced curriculum including jobsite assessment, phases of construction, and hands-on, real-world product applications.



# IRWIN® DESIGN CENTRES

IRWIN® has been delivering high-quality and innovative products for over a century. The experience and knowledge to design and build the IRWIN® products with rigorous testing and quality control are fundamental parts in our ability to offer the best products. Our testing centre facilities across the globe ensure exactly that.

The centres opposite use the very latest technology and testing methods within their specific areas of expertise.



# IRWIN® new products for 2017



# GOVERNMENTS



# HAND TOOLS

**04**  
Pliers & Wrenches



**23**  
Metal Cutting



**31**  
Woodworking



**43**  
Workholding



**64**  
Screwdrivers & Hex Keys



**70**  
Utility Knives & Blades



**78**  
Layout Tools



**84**  
Tool Storage & Workwear



**88**  
Plumbing Tools



# POWER TOOL ACCESSORIES

**92**  
Masonry Drilling

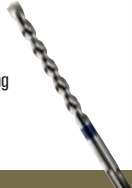

**110**  
Metal Drilling



**125**  
Wood Drilling



**133**  
Drilling Sets



**139**  
Fastener Drives & Screwdriving



**150**  
Circular Saw Blades



**162**  
Bi-Metal Hole Saws



**164**  
Reciprocating Saw Blades



**168**  
Jigsaw Blades



**170**  
Index



**IRWIN®**





# PLIERS & WRENCHES

## WISE-GRIP®

The Vise-Grip® Locking Tool was invented in 1924 by a blacksmith in a small town of DeWitt, Nebraska. William Petersen was a Danish immigrant who invented the first locking pliers in his blacksmith shop, and began selling them from the back of his car to farmers and people in surrounding towns. He patented his new idea and called it VISE-GRIP®.

Since then, VISE-GRIP® has gained global brand recognition as the first choice for locking pliers. Innovation and quality are the core values of the VISE-GRIP® brand. With proven performance in every turn, these are the tools that tradespeople choose first – and pass on to the next generation.

The IRWIN® VISE-GRIP® family offers a full line of locking pliers, water pump pliers, cutting and VDE Pliers. IRWIN® VISE-GRIP® pliers and wrenches continue to set the standard for dependability, quality, and innovation today and tomorrow. Wherever there's a need for a quality tool, IRWIN® VISE-GRIP® is on the job.



## Record®

Originally established in 1898 in the South Yorkshire city of Sheffield in the UK, the Record Tools Factory was swiftly able to make a long lasting contribution to the worldwide reputation of the region for the manufacture of high quality steel and castings.

The Record® brand name was introduced in 1909 and by the 1920's the product range had expanded into vices, planes, clamps and pipe wrenches enabling the business to grow rapidly in the UK and many overseas markets.

Today, IRWIN® Record® continues excelling by sticking to the traditional values set by its founders, producing tools that are highly valued amongst professional users for quality and durability that remains strong today.



### LOCKING TOOLS



### PLIERS



### WRENCHES



# LOCKING PLIERS

### The Original

Since 1924™

IRWIN® VISE-GRIP® Original locking tools, with a classic guarded trigger release, are designed to provide maximum locking force.

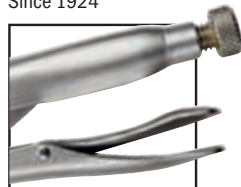

### Fast Release

IRWIN® VISE-GRIP® Fast Release locking pliers have a one-handed, triggerless release, so they're twice as easy to open as the traditional design. Plus, anti-pinch, non-slip ProTouch™ Grips provide comfort, control, and less hand fatigue.



SELF-ENERGISING LOWER JAW

UNIQUE CURVED JAW

PROTOUCH™ GRIPS

**10CR FAST RELEASE LOCKING PLIER - THE PERFECT GRIP FOR ANY JOB.**

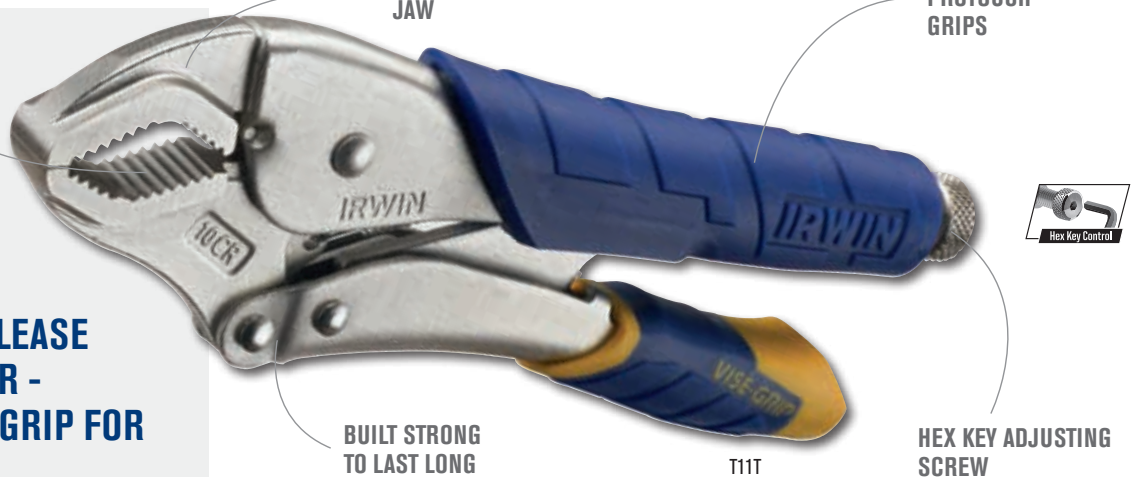

BUILT STRONG TO LAST LONG

T11T

HEX KEY ADJUSTING SCREW

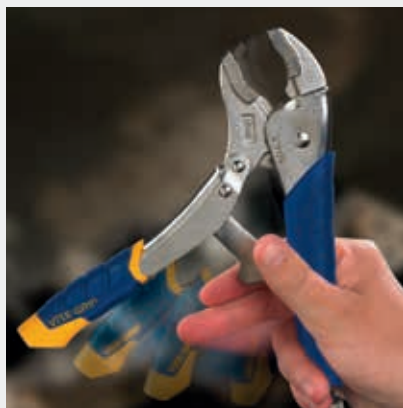

**1. UNIQUE CURVED JAW**

Great for securely gripping and torquing multiple surface shapes, including round pipes, square or hex bolts and more. Perfect for any application that requires maximum torque

**2. SELF-ENERGISING LOWER JAW**

Jaw mechanism provides 3X more gripping power\*. Pivot allows jaw to align on workpiece for maximum grip without slipping or stripping

**3. PROTOUCH™ GRIPS**

Provides comfort, control and less hand fatigue

**4. 2X LONGER LIFE\***

High grade alloy steel is heat treated for maximum toughness and durability

**5. HEX KEY ADJUSTING SCREW**

Tightens to draw material closer together for tighter grip. Loosens to provide controlled release

**3X** MORE GRIPPING POWER\*

**2X** LONGER LIFE\*

**ProTouch**™  
GRIPS

### CURVED JAW LOCKING PLIERS

Self-energising lower jaw provides three times more gripping power, with no slipping or stripping on any style nut or bolt head.

T10T



10508017



ITEM NO.	DESCRIPTION	CAPACITY	EAN	MASTER PACK	SHELF PACK
<b>Fast Release</b>					
T10T	Fast Release - 5CR 5"/ 125mm	29mm	5706915081459	25	5
T13T	Fast Release - 7CR 7"/ 175mm	38mm	5706915081442	25	5
T11T	Fast Release - 10CR 10"/ 250mm	48mm	5706915081435	25	5
<b>The Original</b>					
10508019	Original - 5CR 5"/ 125mm	29mm	5706915080193	25	5
10508018	Original - 7CR 7"/ 175mm	38mm	5706915080186	25	5
10508017	Original - 10CR 10"/ 250mm	48mm	5706915080179	25	5

\*vs. traditional locking pliers



## STRAIGHT JAW LOCKING PLIERS

Straight jaw provides maximum contact on flat, square or hex materials.

ITEM NO.	DESCRIPTION	CAPACITY	EAN	MASTER PACK	SHELF PACK
<b>Fast Release</b>					
T03T	FAST RELEASE - 7R 7"/ 175mm	38mm	5706915081800	25	5
T01T	FAST RELEASE - 10R 10"/ 250mm	48mm	5706915081794	25	5
<b>The Original</b>					
T0302EL4	ORIGINAL - 7R 7"/ 175mm	38mm	38548003016	25	5
T0102EL4	ORIGINAL - 10R 10"/ 250mm	48mm	38548001067	25	5



T01T



T0102EL4

## CURVED JAW LOCKING PLIERS WITH WIRE CUTTER

The curved jaw provides for a better fit around curved work shapes. Built-in wire cutter is great for a variety of applications and material shapes.

ITEM NO.	DESCRIPTION	CAPACITY	EAN	MASTER PACK	SHELF PACK
<b>Fast Release</b>					
T09T	Fast Release - 5WR 5"/ 125mm	29mm	5706915081428	25	5
T07T	Fast Release - 7WR 7"/ 175mm	38mm	5706915081411	25	5
T05T	Fast Release - 10WR 10"/ 250mm	48mm	5706915081404	25	5
<b>The Original</b>					
T1002EL4	Original - 4WR 4"/ 100mm	25mm	38548001098	25	5
T0902EL4	Original - 5WR 5"/ 125mm	29mm	38548009063	25	5
T0702EL4	Original™ - 7WR 7"/ 175mm	38mm	38548007038	25	5
T0502EL4	Original - 10WR 10"/ 250mm	48mm	38548000510	25	5



T05T



T0902EL4

## LONG NOSE LOCKING PLIERS WITH WIRE CUTTER

Long, straight nose provides easy access in narrow, hard-to-reach places.

ITEM NO.	DESCRIPTION	CAPACITY	EAN	MASTER PACK	SHELF PACK
<b>Fast Release</b>					
T14T	Fast Release - 6LN 6"/15mm	51mm	5706915081466	25	5
T15T	Fast Release - 9LN 9"/225mm	70mm	5706915081473	25	5
<b>The Original</b>					
T1602EL4	Original - 4LN 4"/100mm	41mm	38548001678	25	5
T1402EL4	Original - 6LN 6"/150mm	51mm	38548001432	25	5
T1502EL4	Original - 9LN 9"/225mm	70mm	38548001517	25	5



T15T



T1502EL4

## LOCKING C-CLAMPS WITH REGULAR TIPS

Wide-opening jaw provides greater versatility in clamping a variety of shapes.

ITEM NO.	DESCRIPTION	CAPACITY	EAN	MASTER PACK	SHELF PACK
<b>Fast Release</b>					
10507190	Fast Release - 6R 6"/150mm	54mm	5706915071900	25	5
10507189	Fast Release - 11R 11"/275mm	102mm	5706915071894	25	5
<b>The Original</b>					
T17EL4	Original - 6R 6"/150mm	54mm	38548001715	25	5
T19EL4	Original - 11R 11"/275mm	102mm	38548001913	25	5
T18R	Original - 18R - 18"/455mm	203mm	38548000213	-	5
T24R	Original - 24R - 24"/605mm	254mm	38548002750	-	5



10507189



T19EL4

## LOCKING C-CLAMPS WITH DEEP THROAT

The large C-Clamp with greater throat capacity makes this a highly versatility versatile tool in the clamping of wider work-pieces.

ITEM NO.	DESCRIPTION	CAPACITY	EAN	MASTER PACK	SHELF PACK
<b>The Original</b>					
T18DR	Original - 18DR Locking Clamp Deep Throat 18"/455mm	190mm	38548002118	-	5



T18DR



### LOCKING C-CLAMPS WITH SWIVEL PADS

The swivelling pads and greater throat depth allow this clamp to hold irregular shapes and tapered work pieces.



T20EL4

ITEM NO.	DESCRIPTION	CAPACITY	EAN	MASTER PACK	SHELF PACK
T165EL4	Original - 4SP Locking C-Clamp 4"/100mm	41mm	38548001661	25	5
T18EL4	Original - 6SP Locking C-Clamp 6"/150mm	54mm	38548001845	25	5
T9SP	Original - 9SP Locking C-Clamp 9"/225mm	114mm	38548003108	25	5
T20EL4	Original - 11SP Locking C-Clamp 11"/275mm	102mm	38548002019	25	5
T18SP	Original - 18SP Locking C-Clamp 18"/455mm	203mm	38548000220	-	5
T24SP	Original - 24SP Locking C-Clamp 24"/605mm	254mm	38548000282	-	5

### LOCKING WRENCHES

The heavy-duty jaws lock onto three sides of hex fasteners and won't slip or mark workpieces.



4

ITEM NO.	DESCRIPTION	CAPACITY	EAN	MASTER PACK	SHELF PACK
8	Original - 4LW Locking Wrench 4"/100mm	7-14mm	38548002415	25	5
4	Original - 7LW Locking Wrench 7"/175mm	11-19mm	38548000046	25	5
2	Original - 10LW Locking Wrench 10"/250mm	16-28mm	38548000022	25	5

### LARGE JAW LOCKING PLIERS

The heavy-duty jaws grip all shapes; ideal for plumbers, mechanics, welders and large jobs.



12L3

ITEM NO.	DESCRIPTION	CAPACITY	EAN	MASTER PACK	SHELF PACK
12L3	Original - 12LC Large Jaw Locking Plier 12"/300mm	79mm	38548012018	25	5

### LOCKING SHEET METAL TOOL

The sheet metal tool makes bending, forming and crimping sheet metal easier.



23

ITEM NO.	DESCRIPTION	CAPACITY	EAN	MASTER PACK	SHELF PACK
23	Original - 8R Locking Sheet Metal Tool 8"/200mm	78mm	38548000237	25	5

### LOCKING PINCH OFF TOOL

The pinch-off tool provides a temporary seal when applied to tubing, leaving both hands free for other work.



29

ITEM NO.	DESCRIPTION	CAPACITY	EAN	MASTER PACK	SHELF PACK
29	Original - 7RR Locking Pinch-Off Tool 7"/175mm	6mm	38548000299	25	5

### LOCKING PANEL CLAMP

The specially designed jaw provides quick clamping and alignment of automotive body panels.



251

ITEM NO.	DESCRIPTION	CAPACITY	EAN	MASTER PACK	SHELF PACK
251	Original - 9AC Locking Panel Clamp 9"/225mm	70mm	38548002514	25	5

### LOCKING WELDING CLAMP

The U-shape jaw provides enhanced visibility of the weld area and access to the weld space, allowing for more accurate alignment of both round and square shape tubing during welding.



25ZR

ITEM NO.	DESCRIPTION	CAPACITY	EAN	MASTER PACK	SHELF PACK
25ZR	Original - 9R Locking Welding Clamp 9"/225 mm	70 mm	38548000251	25	5



# PLIERS & WRENCHES

## LOCKING CHAIN CLAMP

The chain holds and locks any shape or size up to 18"/455mm. Extension chains are available to extend to any length required.

ITEM NO.	DESCRIPTION	EAN	MASTER PACK	SHELF PACK
27ZR	Original - 20R Locking Chain Clamp 9"/225mm	0038548000275	10	5



## LOCKING PLIERS SPARE PARTS

ITEM NO.	DESCRIPTION	EAN	PCE PER PACK	MASTER PACK	SHELF PACK
2071910	Adjusting Screw 5 Pc. - 10R, 10WR, 10CR, 20R, 12LC, 11R, 11SP, 18R, 18SP, 24R, 24SP, & 10LW	0038548095455	5	100	5
4092	Replacement spring 5pc - 4WR, 4LN, 4SP, 4LW	0038548040929	5	100	5
4935309	Replacement spring 5pc - 18R, 18SP, 24R, 24SP (box and packs marked 40-34)	0038548040349	5	100	5
4008	Replacement spring 5pc - 10R, 10WR, 10CR, 11R, 11SP, 20R, 12LC, 10LW	0038548040080	5	100	5
4022ZR	Replacement spring 5pc - 7R, 7WR, 7CR, 9LN, 8R, RR, 7LW	0038548040226	5	100	5
4052ZR	Replacement spring 5pc - 5WR, 6LN, 6R, 6SP	0038548040523	5	100	5



## LOCKING PLIERS SETS



T77T



T214T



T76KBT



10508020













T71

ITEM NO.	DESCRIPTION	EAN	MASTER PACK	SHELF PACK
T77T	2 pc. Fast Release - (10WR, 6LN)	5706915081480	25	5
T214T	2 pc. Fast Release - (10WR, 7WR)	5706915081497	25	5
T76KBT	3 pc. Fast Release - (10WR, 9LN, 7R) in kitbag	5706915081503	25	5
10508020	3 pc. Original - (5CR, 7CR, 10CR) in storage tray	5706915080209	25	5
T71	4 pc. Original - (10CR, 7R, 6LN, 5WR), in kitbag	0038548000718	-	5
4052ZR	Replacement spring 5pc - 5WR, 6LN, 6R, 6SP	0038548040523	100	5











### LOCKING PLIER RANGE OVERVIEW

IMAGE	ITEM NO.	DESCRIPTION	SIZES	JAW CAPACITY	DESCRIPTION	RECOMMENDED APPLICATIONS				
	T10T	5CR 5"/125mm	5"/125mm	1-1/8" / 29 mm	<b>CURVED JAW LOCKING PLIERS</b> Great for securely gripping and torquing multiple surface shapes, including round pipes, square or hex bolts, and more. Perfect for any application that requires maximum torque.	<b>Gripping Torque Rusted/Broken Screws</b>				
	T13T	7CR 7"/175mm	7"/175mm	1-1/2" / 38 mm						
	T11T	10CR 10"/250mm	10"/250mm	1-7/8" / 48 mm						
	T0508019	5CR 5"/125mm	5"/125mm	1-1/8" / 29 mm						
	T0508018	7CR 7"/175mm	7"/175mm	1-1/2" / 38 mm						
	T0508017	10CR 10"/250mm	10"/250mm	1-7/8" / 48 mm						
	T03T	7R 7"/175mm	7"/175mm	1-1/2" / 38 mm			<b>STRAIGHT JAW LOCKING PLIERS</b> The straight jaw pliers with heavy-duty jaws allow for maximum contact on all work shapes flat or square. It is very popular in welding and other metal work. Use for safer grinding or as a portable vice. The solid steel head makes this tool twice as strong as all other locking pliers.	<b>Holding Welding Clamping</b>		
	T01T	10R 10"/250mm	10"/250mm	1-7/8" / 48 mm						
	T0302EL4	7R 7"/175mm	7"/175mm	1-1/2" / 38 mm						
	T0102EL4	10R 10"/250mm	10"/250mm	1-7/8" / 48 mm						
	T09T	5WR 5"/125mm	5"/125mm	1-1/8" / 29 mm	<b>CURVED JAW LOCKING PLIERS WITH WIRE CUTTER</b> The curved jaw pliers provide for a better fit around curved work shapes. Curved jaw with built-in wire cutter great for a variety of applications and material shapes.	<b>Wire Cutting Pulling, Prying Gripping</b>				
	T07T	7WR 7"/175mm	7"/175mm	1-1/2" / 38 mm						
	T05T	10WR 10"/250mm	10"/250mm	1-7/8" / 48 mm						
	T1002EL4	4WR 4"/100mm	4"/100mm	1" / 25 mm						
	T0902EL4	5WR 5"/125mm	5"/125mm	1-1/8" / 29 mm						
	T0702EL4	7WR 7"/175mm	7"/175mm	1-1/2" / 38 mm						
	T0502EL4	10WR 10"/250mm	10"/250mm	1-7/8" / 48 mm						
	T14T	6LN 6"/150mm	6"/150mm	2" / 51 mm					<b>LONG NOSE LOCKING PLIERS WITH WIRE CUTTER</b> The long tapered nose plier is ideal for delicate work, hobbies, tight spaces, electronics and clamping of small parts. The long nose plier features a built in wire cutter which is helpful in tight spaces.	<b>Reaching Bending Pinching</b>
	T15T	9LN 9"/225mm	9"/225mm	2-3/4" / 70 mm						
	T1602EL4	4LN 4"/100mm	4"/100mm	1-5/8" / 41 mm						
	T1402EL4	6LN 6"/150mm	6"/150mm	2" / 51 mm						
	T1502EL4	9LN 9"/225mm	9"/225mm	2-3/4" / 70 mm						
	T0507190	6R 6"/150mm	6"/150mm	2-1/8" / 54 mm			<b>LOCKING C-CLAMPS WITH REGULAR TIPS</b> The wide-opening jaws provide greater versatility in clamping projects than otherwise available with old fashioned clamps. The C-clamps with regular tips are very popular in welding, auto-body repair and other metal work. The fast release option allows users to move the clamps quickly with one hand while continuing to work with the other.	<b>Fabricating Welding Construction</b>		
	T0507189	11R 11"/275mm	11"/275mm	4" / 102 mm						
	T17EL4	6R 6"/150mm	6"/150mm	2-1/8" / 54 mm						
	T19EL4	11R 11"/275mm	11"/275mm	4" / 102 mm						
	T18R	18R 18"/455mm	18"/455mm	8" / 203 mm						
	T24R	24R 24"/605mm	24"/254mm	10" / 254 mm						



# PLIERS & WRENCHES

IMAGE	ITEM NO.	DESCRIPTION	SIZES	JAW CAPACITY	DESCRIPTION	RECOMMENDED APPLICATIONS
	T165EL4	4SP 4" / 100mm	4" / 100mm	1-5/8" / 41 mm	<b>LOCKING C-CLAMPS WITH SWIVEL PADS</b> The wide-opening jaws with swivel pads hold tapered work, awkward fabricating jobs and delicate projects. The C-Clamps with swivel pads are very popular in auto-body repair and other work on delicate or odd shaped surfaces.	<b>Holding Delicate Seams</b>
	T18EL4	6SP 6" / 150mm	6" / 150mm	2-1/8" / 54 mm		
	T9SP	9SP 9" / 225mm	9" / 225mm	4-1/2" / 114 mm		
	T20EL4	11SP 11" / 275mm	11" / 275mm	4" / 102 mm		
	T18SP	18SP 18" / 455mm	18" / 455mm	8" / 203 mm		
	T24SP	24SP 24" / 605mm	24" / 254mm	10" / 254 mm		
	T9DR	9DR 9" / 225mm	9" / 225mm	4-1/2" / 114 mm	<b>LOCKING C-CLAMPS - DEEP THROAT</b> These clamps have extra throat width and depth for greater clamping reach. These features allow for many clamping applications in welding, automotive and steel framing.	<b>Fabricating Welding Construction</b>
	T18DR	18DR 18" / 455mm	18" / 455mm	7-1/2" / 190 mm		
	23	8R 8" / 200mm	8" / 200mm	3-1/8" / 78 mm	<b>LOCKING SHEET METAL TOOL</b> The Locking Sheet Metal tool locks on to work with a powerful grip. The tool makes all kinds of bending, forming and crimping jobs easier and faster.	<b>Bending Crimping Forming</b>
	25ZR	9R 8" / 225mm	9" / 225mm	2-3/4" / 70 mm	<b>LOCKING WELDING CLAMP</b> The Locking Welding Clamp has deep-throated and U-shaped jaws for visibility and working space. It holds work in proper alignment and is ideal for sheet metal work on automobiles.	<b>Welding Holding</b>
	27ZR	20R 9" / 225mm	9" / 225mm	18" / 455 mm	<b>LOCKING CHAIN CLAMP</b> The Locking Chain Clamp holds and locks around any shape or any size of object and adjusts quickly for ratchet action in either direction. Extension chain is available.	<b>Holding</b>
	29	RR 7" / 175mm	7" / 175mm	1/4" / 6 mm	<b>LOCKING PINCH-OFF TOOL</b> The Locking Pinch-Off tool with round jaws pinches and locks on tubing instantly without damaging the tubing. It is perfect to use for plumbing work, as it stops flow from untidy tubes. Very popular in the refrigeration market.	<b>Holding</b>
	251	9AC Locking Panel Clamp	9" / 225mm	2-3/4" / 70 mm	<b>LOCKING PANEL CLAMP</b> The jaws for the Locking Panel Clamp are designed to move in a straight line motion which allows the handle to be out of the way. Auto-body panels can be clamped in place and the door shut to check for gaps before final welding.	<b>Clamping Welding</b>
	8	4LW 4" / 100mm	4" / 100mm	7 mm - 14 mm	<b>LOCKING WRENCH</b> The jaws of the Locking Wrench lock on three sides of a bolt and will not slip or mark. The Locking Wrench is adjustable to over 16 wrench sizes and features a built-in wire cutter.	<b>Pulling Tightening</b>
	4	7LW 7" / 175mm	7" / 175mm	11 mm - 19 mm		
	2	10LW 10" / 250mm	10" / 250mm	16 mm - 28 mm		
	12L3	12LC 12" / 300mm	12" / 300mm	3-1/8" / 79 mm	<b>LARGE JAW LOCKING PLIER</b> The large jaws and clamping ability make this tool ideal for plumbers, mechanics, welders and others who work with large objects. Also, its convenient size makes it easier to use than bulkier tools, such as pipe wrenches.	<b>Holding Clamping</b>



**IRWIN®**

**WISE-GRIP®**





## GROOVELOCK WATER PUMP PLIERS WITH PROTOUCH™ GRIP

ALL-PURPOSE JAW

PRESS-N-SLIDE BUTTON

ANTI-PINCH NON-SLIP PROTOUCH GRIPS



MULTI-GROOVE RATCHETING SYSTEM

10507627

### WATER PUMP PLIERS

GrooveLock Pliers are designed with twice the number of groove positions as traditional groove joint pliers to deliver optimal hand and jaw positioning - providing a superior grip. The specially engineered, all-purpose jaw grips round, hex, square and flat surfaces for incredible versatility.

- 1. ALL-PURPOSE JAW**  
Grips onto flat, round, hex & square work pieces to provide tremendous bite
- 2. PRESS-N-SLIDE BUTTON**  
Adjusts jaws 2X faster than traditional groove joint pliers
- 3. MULTI-GROOVE RATCHETING SYSTEM**  
Has twice the groove positions than other groove joint pliers, for precise positioning on any type of work surface
- 4. ANTI-PINCH NON-SLIP PROTOUCH GRIPS**  
Provide comfort, control and less hand fatigue

**2X FASTER\***  
\*vs traditional Groove Joint pliers

**ProTouch**  
GRIPS

**GrooveLock**  
Pliers

ITEM NO.	DESCRIPTION	JAW CAPACITY	EAN	MASTER PACK	SHELF PACK
10507626	GV6 GrooveLock PTG 6"/150mm	29mm	5706915076264	25	5
10507627	GV8 GrooveLock PTG 8"/200mm	45mm	5706915076271	25	5
10507628	GV10 GrooveLock PTG 10"/250mm	57mm	5706915076288	25	5
4935097	GV10S GrooveLock PTG 10"/250mm Smooth Jaw	57mm	38548108629	25	5
10507629	GV12 GrooveLock PTG 12"/300mm	70mm	5706915076295	20	5



### GROOVELOCK WATER PUMP PLIERS WITH THIN GRIP

ITEM NO.	DESCRIPTION	CAPACITY	EAN	MASTER PACK	SHELF PACK
10507630	GV6 GrooveLock TG 6"/150mm	29mm	5706915076301	25	5
10507631	GV8 GrooveLock TG 8"/200mm	45mm	5706915076318	25	5
10507632	GV10 GrooveLock TG 10"/250mm	57mm	5706915076325	20	5
10507633	GV12 GrooveLock TG 12"/300mm	70mm	5706915076332	25	5
2078116	GV16 GrooveLock TG 16"/400mm	114mm	38548088099	10	2
2078120	GV20 GrooveLock TG 20"/510mm	152mm	38548088105	5	1



### WATER PUMP PLIERS

IRWIN® VISE-GRIP® Universal Water Pump pliers feature an all-purpose jaw, specially engineered to grip round, hex, square and flat surfaces. They are available with ProTouch™ grips (PTG) or thin grips (TG).

#### UNIVERSAL WATER PUMP PLIERS WITH PROTOUCH™ GRIP

	ITEM NO.	DESCRIPTION	CAPACITY	EAN	MASTER PACK	SHELF PACK
 10507636	10507634	Universal Water Pump Pliers PTG 6"/150mm	29mm	5706915076349	25	5
	10507635	Universal Water Pump Pliers PTG 8"/200mm	45mm	5706915076356	25	5
	10507636	Universal Water Pump Pliers PTG 10"/250mm	57mm	5706915076363	25	5
	10507637	Universal Water Pump Pliers PTG 12"/300mm	70mm	5706915076370	25	5

#### UNIVERSAL WATER PUMP PLIERS WITH THIN GRIP

	ITEM NO.	DESCRIPTION	CAPACITY	EAN	MASTER PACK	SHELF PACK
 10507640	10507638	Universal Water Pump Pliers TG 6"/150mm	29mm	5706915076387	25	5
	10507639	Universal Water Pump Pliers TG 8"/200mm	45mm	5706915076394	25	5
	10507640	Universal Water Pump Pliers TG 10"/250mm	57mm	5706915076400	25	5
	10507641	Universal Water Pump Pliers TG 12"/300mm	70mm	5706915076417	25	5

### GROOVE JOINT PLIERS

IRWIN® VISE-GRIP® Groove Joint pliers feature right angle teeth which grip in all directions for maximum bite. They all have moulded ProTouch™ grips for added comfort and less hand fatigue.

#### GROOVE JOINT PLIERS WITH PROTOUCH™ GRIPS

	ITEM NO.	DESCRIPTION	CAPACITY	EAN	MASTER PACK	SHELF PACK
 10505500	10505498	Groove Joint Plier 8"/200mm	38mm	5706915054989	25	5
	10505500	Groove Joint Plier 10"/250mm	51mm	5706915055009	25	5
	10505502	Groove Joint Plier 12"/300mm	57mm	5706915055023	25	5



## WISE-GRIP PLIERS

IRWIN® VISE-GRIP® traditional pliers have induction hardened cutting edges which stay sharp longer. The pliers also feature machined jaws for maximum gripping strength and moulded ProTouch™ grips for added comfort and less hand fatigue. TÜV/GS approvals demonstrate the high manufacturing standards of these VISE-GRIP® tools.

**MULTI-GRIP JAWS**

**INDUCTION HARDENED CUTTING FACE**

**PROTOUCH™ GRIPS**

**CHROMIUM NICKEL STEEL**

**CABLE CUTTER**

**COMBINATION PLIERS**

**ProTouch™ GRIPS**

**TÜV SÜD** **GS**

- MULTI-GRIP JAWS**  
With maximum gripping groove design
- PROTOUCH™ GRIPS**  
Are moulded for comfort and provide less hand fatigue
- INDUCTION HARDENED CUTTING FACE**  
To stay sharper, longer
- CABLE CUTTER**  
Up to Ø 1,6mm cables
- CHROMIUM NICKEL STEEL**  
For improved durability on the gripping and cutting face

ITEM NO.	DESCRIPTION	EAN	MASTER PACK	SHELF PACK
10505875	Combination Plier 6"/150mm	5706915058758	25	5
1910231	Combination Plier 7"/175mm	5706915058772	25	5
10505876	Combination Plier 8"/200mm	5706915058765	25	5



### DIAGONAL CUTTING PLIERS

Induction hardened cutting edges designed to stay sharper longer for wire cutting

ITEM NO.	DESCRIPTION	EAN	MASTER PACK	SHELF PACK
10505493	Diagonal Cutting Pliers 6"/150mm	5706915054934	25	5
10505494	Diagonal Cutting Pliers 7"/175mm	5706915054941	25	5
10505495	Diagonal Cutting Pliers 8"/200mm	5706915054958	25	5



### END CUTTING PLIERS

Throat clearance allows semi-flush cutting of nails and rivets

ITEM NO.	DESCRIPTION	EAN	MASTER PACK	SHELF PACK
10505517	End Cutting Pliers 8"/200mm	5706915055177	25	5
10505518	Cable Cutter 8"/200mm	5706915055184	25	5



### LONG NOSE PLIERS

Thin nose profile gets into tight spaces and is easier to reach around obstructions



10505504

ITEM NO.	DESCRIPTION	EAN	MASTER PACK	SHELF PACK
10505503	Long Nose Pliers 6"/150mm	5706915055030	25	5
10505504	Long Nose Pliers 8"/200mm	5706915055047	25	5

### BENT NOSE PLIERS

Thin, angled nose profile gets into tight spaces and is easier to reach around obstructions



10505506

ITEM NO.	DESCRIPTION	EAN	MASTER PACK	SHELF PACK
10505505	Bent Nose Pliers 6"/150mm	5706915055054	25	5
10505506	Bent Nose Pliers 8"/200mm	5706915055061	25	5

### NIPPER PLIERS

Throat clearance allows for semi-flush cutting



10508151

ITEM NO.	DESCRIPTION	EAN	MASTER PACK	SHELF PACK
10508153	Nipper Plier TG 6"/150mm	5706915081534	25	5
10508152	Nipper Plier TG 7"/175mm	5706915081527	25	5
10508151	Nipper Plier TG 8"/200mm	5706915081534	25	5

### CONSTRUCTION NIPPERS

Precision-machined jaws and induction hardened cutting edge provide a clean cut



10508154

ITEM NO.	DESCRIPTION	EAN	MASTER PACK	SHELF PACK
10508154	Construction Nippers TG 9"/225mm	5706915081541	25	5

### NAIL PULLERS

Machined jaws provide maximum gripping strength



10508157

ITEM NO.	DESCRIPTION	EAN	MASTER PACK	SHELF PACK
10508156	Nail Puller TG 10"/250mm	5706915081565	25	5
10508157	Nail Puller TG 8"/200mm	5706915081572	25	5

### TRADITIONAL PLIER SET



10505483

ITEM NO.	DESCRIPTION	EAN	MASTER PACK	SHELF PACK
10505483	ProPliers 3pcs Set (6"/150mm Diagonal Cutter, 8"/200mm Long Nose Plier, 7"/175mm Combination Plier)	5706915054835	5	5



### WHAT IS TÜV & GS?

- GUARANTEED SAFETY TO DIN STANDARDS
- PROVEN QUALITY & RELIABILITY



# PLIERS & WRENCHES

## ADJUSTABLE WRENCHES

IRWIN® VISE-GRIP® wrenches have scales in metric and imperial, and are available with ProTouch™ Grip for added comfort. TÜV/GS approvals demonstrate the high manufacturing standards of the VISE-GRIP® sub-brand. Parallel jaws with smooth surfaces assist a secure grip and help prevent scratches.

### ADJUSTABLE WRENCH WITH PROTOUCH GRIP

ITEM NO.	DESCRIPTION	CAPACITY	EAN	MASTER PACK	SHELF PACK
10505486	Adjustable Wrench PTG 6"/150mm	1"/25mm	5706915054866	25	5
10505488	Adjustable Wrench PTG 8"/200mm	1-1/8" / 28mm	5706915054880	25	5
10505490	Adjustable Wrench PTG 10"/250mm	1-1/4" / 31mm	5706915054903	25	5
10505492	Adjustable Wrench PTG 12"/300mm	1-1/2" / 38mm	5706915054927	20	5



10505492

### ADJUSTABLE WRENCH WITH STEEL HANDLE

ITEM NO.	DESCRIPTION	CAPACITY	EAN	MASTER PACK	SHELF PACK
10508161	Adjustable Wrench Steel Handle 6"/150mm	1" / 25mm	5706915081619	20	5
10508160	Adjustable Wrench Steel Handle 8"/200mm	1-1/8" / 28mm	5706915081602	20	5
10508159	Adjustable Wrench Steel Handle 10"/250mm	1-1/4" / 31mm	5706915081596	20	5
10508158	Adjustable Wrench Steel Handle 12"/300mm	1-1/2" / 38mm	5706915081589	20	5



10508160



## WHAT IS TÜV & GS?

- GUARANTEED SAFETY TO DIN STANDARDS
- PROVEN QUALITY & RELIABILITY

All Products on this page are TÜV/GS certified for optimal safety and user confidence.

**ProTouch**  
GRIPS



### VDE PLIERS



#### VDE COMBINATION PLIERS

IRWIN® Vise-Grip® VDE Pliers are fully TÜV, GS and VDE certified, meaning they are guaranteed safe for working with electrical equipment up to AC 1000V or DC 1500V. Their induction hardened cutting edges stay sharp longer, and their machined jaws are designed for maximum gripping strength. Plus, their ProTouch™ grips provide extra comfort for less hand fatigue.

1. **CROSS-HATCHED JAWS**  
Maximum gripping
2. **PROTOUCH™ GRIPS**  
For comfort and reduced hand fatigue
3. **INDUCTION HARDENED CUTTING FACE**  
Stays sharper longer
4. **CABLE CUTTER**  
Up to Ø 1.6mm cables
5. **CHROMIUM NICKEL STEEL**  
For improved durability on the gripping and cutting face



10505874

ITEM NO.	DESCRIPTION	EAN	MASTER PACK	SHELF PACK
10505872	VDE Combination Pliers 6"/150mm	5706915058727	25	5
10505873	VDE Combination Pliers 7"/175mm	5706915058734	25	5
10505874	VDE Combination Pliers 8"/200mm	5706915058741	25	5

#### VDE LONG AND BENT NOSE PLIERS

Thin nose profile gets into tight spaces, easy to reach around obstructions



10505869

ITEM NO.	DESCRIPTION	EAN	MASTER PACK	SHELF PACK
10505868	VDE Long Nose Pliers 6"/150mm	5706915058680	25	5
10505869	VDE Long Nose Pliers 8"/200mm	5706915058697	25	5
10505870	VDE Bent Nose Pliers 8"/200mm	5706915058703	25	5



10505870



#### WHAT IS TÜV & GS?

- GUARANTEED SAFETY TO DIN STANDARDS
- PROVEN QUALITY & RELIABILITY

#### WHAT IS VDE

- SAFELY WORKING WITH ELECTRICAL EQUIPMENT UP TO AC OR DC 1500VOLT

All Products on this page are TÜV/GS certified for optimal safety and user confidence.



## VDE DIAGONAL CUTTING PLIERS

Induction hardened cutting edges designed to stay sharper longer for wire cutting

ITEM NO.	DESCRIPTION	EAN	MASTER PACK	SHELF PACK
10505865	VDE Diagonal Cutting Pliers 6"/150mm	5706915058659	25	5
10505866	VDE Diagonal Cutting Pliers 7"/175mm	5706915058666	25	5
10505867	VDE Diagonal Cutting Pliers 8"/200mm	5706915058673	25	5



10505865

## VDE WIRE STRIPPER

V-shape Cutters provide easy and precise wire stripping up to Ø 1,6 mm cables

ITEM NO.	DESCRIPTION	EAN	MASTER PACK	SHELF PACK
10505871	VDE Wire Strippers 6"/150mm	5706915058710	25	5



## VDE PLIERS SET

ITEM NO.	DESCRIPTION	EAN	MASTER PACK	SHELF PACK
10505519	3pcs Set (6"/150mm diagonal cutter, 8"/200mm long nose plier, 7"/175mm combination plier)	5706915055191	5	5



10505519



## WHAT IS TÜV & GS?

- GUARANTEED SAFETY TO DIN STANDARDS
- PROVEN QUALITY & RELIABILITY

## WHAT IS VDE

- SAFELY WORKING WITH ELECTRICAL EQUIPMENT UP TO AC OR CD1500VOLT

All Products on this page are TÜV/GS certified for optimal safety and user confidence.



**IRWIN**<sup>®</sup>

*Record*<sup>®</sup>





## PIPE WRENCHES

IRWIN® Record® offer a full range of plumbing tools designed to get the job done quickly and efficiently. From our solid-forged Stillson Wrenches to the lightweight Quick-Adjusting Wrench, our range of pipe tools offer superior grip due to the unique 'V-shaped' tooth profile.

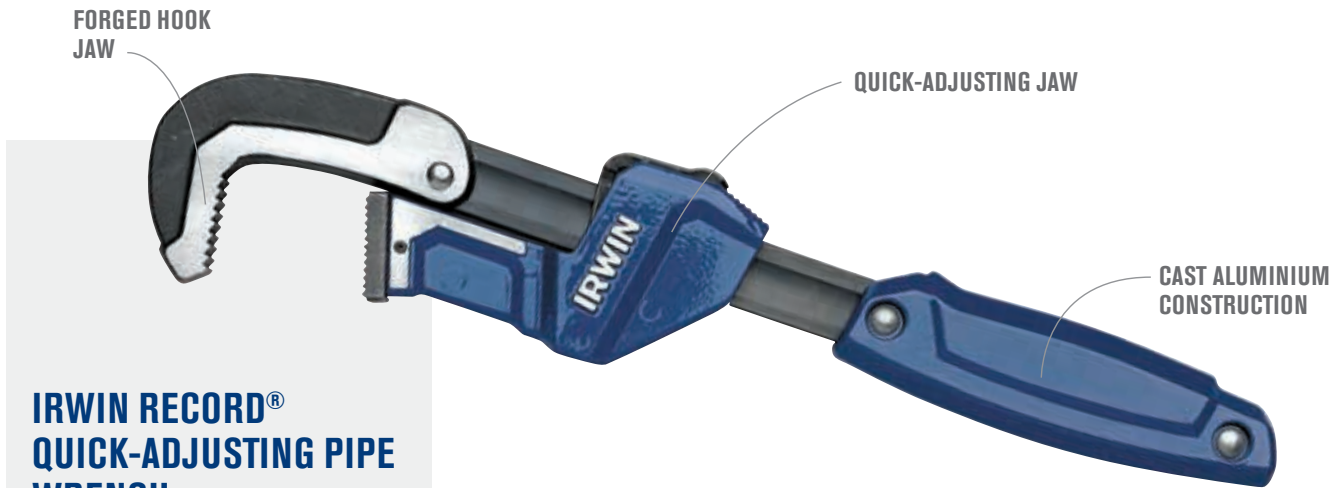

### IRWIN RECORD® QUICK-ADJUSTING PIPE WRENCH

**3X FASTER\***

#### 1. FORGED HOOK JAW

With 2-1/4" (58mm) jaw capacity equivalent to standard 14" (350mm) pipe wrench; ideal for pipe diameters up to 1-1/2" (38mm); ideal for most surfaces including black, galvanized, PVC and copper pipe, as well as nuts, bolts and couplings; broached teeth

#### 2. QUICK-ADJUSTING JAW

With one-handed operation, ratchets quickly to work the surface

#### 3. CAST ALUMINIUM CONSTRUCTION

40% less weight than standard 14" (350mm) cast iron pipe wrench; ergonomic handle is ideal for heavy torque and maximum comfort



ITEM NO.	DESCRIPTION	CAPACITY	EAN	MASTER PACK	SHELF PACK
10503642	Quick-Adjusting Wrench	3 - 58mm	5706915036428	-	5



### STILLSON PIPE WRENCHES

Solid forged handle and jaw with One Piece Unbreakable (S.G.) iron.

ITEM NO.	DESCRIPTION	CAPACITY	EAN	MASTER PACK	SHELF PACK
T3008	Stillson Wrench 8"/200mm	3/4" / 19mm	734442111122	-	6
T30010	Stillson Wrench 10"/250mm	1" / 25mm	734442111368	-	6
T30012	Stillson Wrench 12"/300mm	1-1/4" / 32mm	734442111603	-	6
T30014	Stillson Wrench 14"/350mm	1-1/2" / 38mm	734442111849	-	6
T30018	Stillson Wrench 18"/450mm	2" / 51mm	734442111962	-	6
T30024	Stillson Wrench 24"/600mm	2-1/2" / 63mm	734442112082	-	6
T30036	Stillson Wrench 36"/900mm	3-1/2" / 89mm	734442112204	-	6



### STILLSON WRENCHES SPARE PARTS

ITEM NO.	DESCRIPTION	EAN	MASTER PACK	SHELF PACK
T30018A	Jaw Complete with Nut (F)	734442120605	1	4
T30036A	Jaw Complete with Nut (F)	734442121800	1	4
T30018C	Frame with Pin (D) & Coil Spring (E)	734442120841	1	4
T30036C	Frame with Pin (D) & Coil Spring (E)	734442122043	1	4
T30024F	Nut (New Thread)	734442117728	1	4
T30036F	Nut	734442119883	1	1

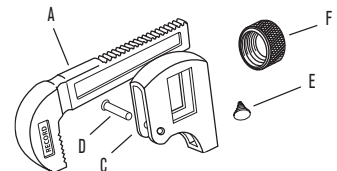

\* Than traditional pipe wrenches

### LEADER PIPE WRENCHES

Heavy-duty frame and handle are a one-piece ductile iron casting guaranteed against breakage.



T3508

ITEM NO.	DESCRIPTION	CAPACITY	EAN	MASTER PACK	SHELF PACK
T3508	Leader Wrench 8"/200mm	1" (25mm)	734442112440	-	4
T35010	Leader Wrench 10"/250mm	1-1/2" (38mm)	734442112563	-	4
T35012	Leader Wrench 12"/300mm	2" (51mm)	734442112327	-	4
T35014	Leader Wrench 14"/350mm	2" (51mm)	734442112686	-	4
T35018	Leader Wrench 18"/450mm	2-1/2" (63mm)	734442112808	-	4
T35024	Leader Wrench 24"/600mm	3" (76mm)	734442112921	-	1
T35036	Leader Wrench 36"/900mm	5" (127mm)	734442113041	-	1
T35048	Leader Wrench 48"/1220mm	6" (152mm)	734442113065	-	1

### LEADER WRENCHES SPARE PARTS

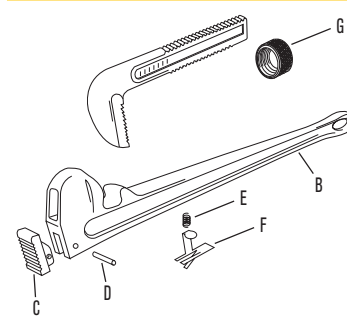

ITEM NO.	DESCRIPTION	CAPACITY	EAN	MASTER PACK	SHELF PACK
T35018A	Hook Jaw c/w Nut (G)	-	734442125280	1	4
T35024A	Hook Jaw c/w Nut (G)	-	734442126126	1	4
T35036A	Hook Jaw c/w Nut (G)	-	734442126966	1	4
T35048A	Hook Jaw c/w Nut (G)	-	734442127802	1	4
T35010C	Handle Jaw with Pin (D)	-	734442123842	1	4
T35018C	Handle Jaw with Pin (D)	-	734442125402	1	1
T35024C	Handle Jaw with Pin (D)	-	734442126249	1	1
T35048C	Handle Jaw with Pin (D)	-	734442127925	1	1
T35010E	Coil Spring (E) & Flat Spring (F)	-	734442124085	1	1

### HANDIWRENCH

Chain pipe wrenches are mainly used in confined spaces, such as against a wall or close to a nest of other piping. Simply loop the chain around the pipe, lock it and the jaws will grip in the direction of the turn. The pipe can then be easily tightened or loosened with short strokes of the handle.



ITEM NO.	DESCRIPTION	CAPACITY	EAN	MASTER PACK	SHELF PACK
T240	HandiWrench Ø100	4" (101mm)	734442113522	48	4

### CHAIN PIPE WRENCHES



T235C

ITEM NO.	DESCRIPTION	CAPACITY	EAN	MASTER PACK	SHELF PACK
T23112	Chain Pipe Wrench Ø61mm/14"	5/16" - 2" / 8-51mm	734442109082	12	1
T23212	Chain Pipe Wrench Ø90mm/21-1/2"	5/16" - 3" / 8-76mm	734442109204	12	1
T233C	Chain Pipe Wrench Ø115mm/36"	1/2" - 4" / 13-101mm	734442113164	6	1
T234C	Chain Pipe Wrench Ø220mm/51"	1" - 8" / 25-203mm	734442113287	6	1
T235C	Chain Pipe Wrench 64-1/2"	2" - 12" / 50 - 300mm	734442114000	6	1

### CHAIN PIPE WRENCHES REPLACEMENT CHAINS

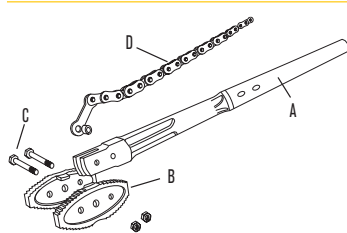

ITEM NO.	DESCRIPTION	CAPACITY	EAN	MASTER PACK	SHELF PACK
T233CDB	Chain with Bush (D)	-	734442113881	1	1
T234CDB	Chain with Bush (D)	-	734442114246	1	1

# METAL CUTTING





## HACKSAW BLADES

### BI-METAL HACKSAW BLADES

IRWIN® high-quality hacksaw blades provide improved cutting performance. Their tooth geometry delivers higher resistance against tooth strippage and increases longevity and durability. Leveraging the advantages of WeldTec™ technology, IRWIN® hacksaw blades allow for faster, smoother and less tiring cutting.



10504523

#### 1. WELDTEC TECHNOLOGY

Innovative tooth geometry withstands wear and keeps the blade sharp for a long time

#### 2. BI-METAL CONSTRUCTION

Prevents blades from shattering and delivers long blade life

### BI-METAL HACKSAW BLADES

ITEM NO.	DESCRIPTION	EAN	MASTER PACK	SHELF PACK
10504523	Bi-Metal Hacksaw Blade 18TPI, 12" / 300mm, 2 pcs.	5706915045239	90	1
10504524	Bi-Metal Hacksaw Blade 24TPI, 12" / 300mm, 2 pcs.	5706915045246	90	1
10504525	Bi-Metal Hacksaw Blade 32TPI, 12" / 300mm 2 pcs.	5706915045253	90	1
10507929	Bi-Metal Hacksaw Blade 3pk (one each 18, 24 & 32TP), 12" / 300mm	5706915079296	150	1
10505897	Bi-Metal Hacksaw Blade 18TPI, 12" / 300mm, 10 pcs.	5706915058970	50	1
10505898	Bi-Metal Hacksaw Blade 24TPI, 12" / 300mm, 10 pcs.	5706915058987	50	1
10505899	Bi-Metal Hacksaw Blade 32TPI, 12" / 300mm, 10 pcs.	5706915058994	50	1
10504520	Bi-Metal Hacksaw Blade 18TPI, 12" / 300mm, 100 pcs.	5706915045208	5	1
10504521	Bi-Metal Hacksaw Blade 24TPI, 12" / 300mm, 100 pcs.	5706915045215	5	1
10504522	Bi-Metal Hacksaw Blade 32TPI, 12" / 300mm, 100 pcs.	5706915045222	5	1
10504530	Junior Hacksaw Wood Blade 14TPI, 6" / 150mm, 10 pcs.	5706915045307	10	1
10504531	Junior Hacksaw Wood Blade 32TPI, 6" / 150mm, 10 pcs.	5706915045314	10	1



## HACKSAW FRAMES

The IRWIN® Hacksaw frames are built to meet the professional's demanding needs. The durable IRWIN® frames make cutting quick and easy.

**JAB SAW OPTION**

**I - 125 HIGH-TENSION HACKSAW (125kg/25,000 PSI)**

The IRWIN® heavy-duty hacksaw frame is able to reach over 125kg blade tension to ensure accurate cutting. The soft-touch handle gives professionals a solid and slip-free grip.

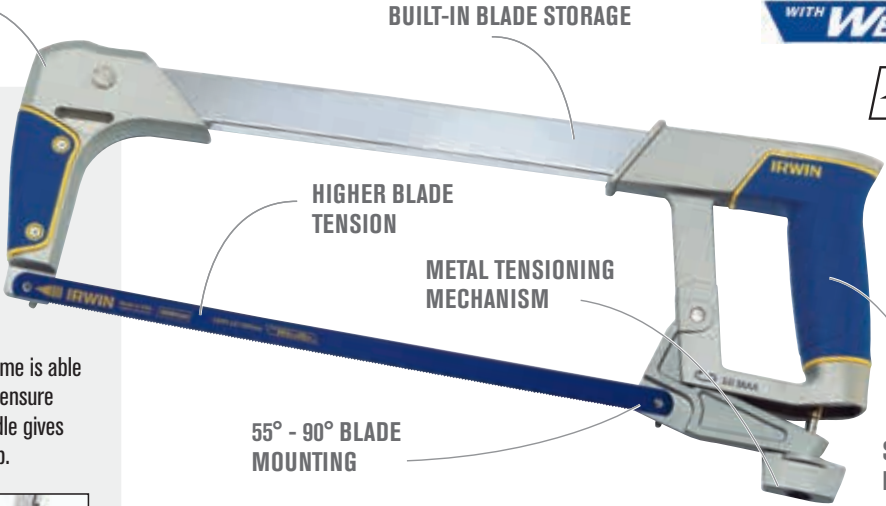

10504407

1. **HIGHER BLADE TENSION**  
For straight cuts and prevents blade being released when dropped
2. **METAL TENSIONING MECHANISM**  
For a longer lasting tool
3. **SOFT TOUCH HANDLE**  
Ensure a comfortable sawing grip and prevents slippage
4. **BUILT-IN BLADE STORAGE**  
So spare blades easily accessible
5. **55° - 90° BLADE MOUNTING**  
For sawing large objects
6. **JAB SAW OPTION**  
For sawing in confined spaces

ITEM NO.	DESCRIPTION	EAN	MASTER PACK	SHELF PACK
10504407	I-125 Hacksaw for 12" / 300mm blades	5706915044072	10	10

### I - 75 LOW TENSION HACKSAW (75kg/15,000 PSI)

This lightweight durable full metal frame - tensions up to 15,000 PSI with a full metal tensioning mechanism. 90° to 180° blade mounting is available for sawing large objects.

ITEM NO.	DESCRIPTION	EAN	MASTER PACK	SHELF PACK
10506437	I-75 Low-Tension Hacksaw for 12" / 300mm blades	5706915064377	10	10



### MINI HACKSAW

Ergonomic handle for secure and comfortable cutting. Optimised for work in confined places.

ITEM NO.	DESCRIPTION	EAN	MASTER PACK	SHELF PACK
10504408	Mini Hacksaw, 10" / 250mm blade	5706915044089	60	5



### JUNIOR HACKSAW

Durable metal frame and easy tensioning mechanism allows for higher blade tension and improved cutting. The ergonomic handle delivers comfortable sawing.

ITEM NO.	DESCRIPTION	EAN	MASTER PACK	SHELF PACK
10504409	Junior Hacksaw for 6" / 150mm Blades	5706915044096	60	5



### BOLT CUTTERS

IRWIN® Record® bolt cutters made their debut in 1923. IRWIN® Record® bolt cutters combine specially formulated steel jaws and exacting manufacturing techniques to make a range of cutters that will handle high, low and medium tensile materials of all kinds.

#### HEAVY-DUTY ARM-ADJUSTED DROP FORGED HANDLES – CENTRE CUT

Designed to withstand the most extreme situations, high-tensile drop-forged and ground steel jaws have also gone through a two-stage heat treatment to significantly increase durability and offer a stable cut capacity. Drop-forged steel handles provide safety and reliability and offer optimal performance for cutting high-tensile material.



TB918H

EACH JAW IS PROGRESSIVELY HEAT TREATED to give a penetrating cutting edge and resilient body JAWS ARE DROP-FORGED from a specially formulated steel machined to precise specifications COMPOUND ACTION supplies 80lbs of force for every 1lb applied to the handles DROP-FORGED steel handles SAFETY STOPS prevent trapped fingers	ITEM NO.	DESCRIPTION	EAN	MASTER PACK	SHELF PACK
		T914H	Arm Adjusted Bolt Cutters 14" / 355mm	0734442089162	10
	T918H	Arm Adjusted Bolt Cutters 18" / 460mm	0734442087489	10	1
	T924H	Arm Adjusted Bolt Cutters 24" / 610mm	0734442134046	4	1
	T930H	Arm Adjusted Bolt Cutters 30" / 760mm	0734442092643	2	1
	T936H	Arm Adjusted Bolt Cutters 36" / 915mm	0734442092766	2	1
	T942H	Arm Adjusted Bolt Cutters 42" / 1070mm	0734442092889	1	1

#### MEDIUM-DUTY CAM-ADJUSTED DROP FORGED HANDLES – CENTRE CUT

The cam adjusted bolt cutters are perfect for medium duty work on a daily basis. The drop-forged steel handles provide safe and reliable action along with specially formulated and heat-treated induction hardened steel heads.



TBC918H

ITEM NO.	DESCRIPTION	EAN	MASTER PACK	SHELF PACK
TBC914H	Cam Adjusted Bolt Cutters 14" / 355mm	0734442090847	10	1
TBC918H	Cam Adjusted Bolt Cutters 18" / 460mm	0734442092407	10	1
TBC924H	Cam Adjusted Bolt Cutters 24" / 610mm	0734442092520	4	1
TBC930H	Cam Adjusted Bolt Cutters 30" / 760mm	0734442092667	3	1
TBC936H	Cam Adjusted Bolt Cutters 36" / 915mm	0734442092780	2	1

#### GENERAL PURPOSE CAM-ADJUSTED TUBULAR HANDLES – CENTRE CUT

The cam adjusted high-tensile tubular handled bolt cutter are lightweight and easy to maintain. Great for help around the workshop, farm or garage.



TTBC918

ITEM NO.	DESCRIPTION	EAN	MASTER PACK	SHELF PACK
TTBC914	Cam Adjusted Tubular Handled Bolt Cutters 14" / 355mm	0734442089834	10	1
TTBC918	Cam Adjusted Tubular Handled Bolt Cutters 18" / 460mm	0734442089841	8	1
TTBC924	Cam Adjusted Tubular Handled Bolt Cutters 24" / 610mm	0734442089858	6	1
TTBC930	Cam Adjusted Tubular Handled Bolt Cutters 30" / 760mm	0734442089896	4	1
TTBC936	Cam Adjusted Tubular Handled Bolt Cutters 36" / 915mm	0734442089902	3	1

#### MEDIUM-DUTY CAM-ADJUST DROP FORGED HANDLES – END CUT

Designed for close cropping low-tensile and non-ferrous materials in confined spaces.



TBC924E

ITEM NO.	DESCRIPTION	EAN	MASTER PACK	SHELF PACK
TBC924E	Cam Adjusted Bolt Cutter -End Cut 24"/610 mm	0734442093008	6	1



## MEDIUM-DUTY CABLE CUTTERS

Drop-forged steel heads with long tubular handles for cutting a variety of wire and cable.

ITEM NO.	DESCRIPTION	EAN	MASTER PACK	SHELF PACK
TWC6	Spring Handle Wire Cutter for Small, Solid and Strand Wire	5011117175609	6	1
TWC16	Up to 16 mm Wire Rope & 21mm OD Armoured Electric Cable	0734442175704	10	1
TCC26	Up to 26 mm Un-Armoured Copper & Aluminium Cable	0734442176008	10	1



## REPLACEMENT JAWS - CENTRE CUT

ITEM NO.	DESCRIPTION	EAN	MASTER PACK	SHELF PACK
TJ914H	Replacement Jaw - Center Cut, Fits 14" / 355mm Bolt Cutters	0734442094579	-	1
TJ918H	Replacement Jaw - Center Cut, Fits 18" / 460mm Bolt Cutters	0734442096009	-	1
TJ924H	Replacement Jaw - Center Cut, Fits 24" / 610mm Bolt Cutters	0734442096122	-	1
TJ930H	Replacement Jaw - Center Cut, Fits 30" / 760mm Bolt Cutters	0734442096245	-	1
TJ936H	Replacement Jaw - Center Cut, Fits 36" / 915mm Bolt Cutters	0734442096368	-	1
TJ942H	Replacement Jaw - Center Cut, Fits 42" / 1070mm Bolt Cutters	0734442096481	-	1



## REPLACEMENT JAWS - CLIPPER CUT

ITEM NO.	DESCRIPTION	EAN	MASTER PACK	SHELF PACK
TJ918F	Replacement Jaw - Clipper Cut, Fits 18" / 460mm Bolt Cutters	0734442094685	-	1
TJ924F	Replacement Jaw - Clipper Cut, Fits 24" / 610mm Bolt Cutters	0734442094807	-	1
TJ930F	Replacement Jaw - Clipper Cut, Fits 30" / 760mm Bolt Cutters	0734442094920	-	1



## REPLACEMENT JAWS - CLIPPER CUT

ITEM NO.	DESCRIPTION	EAN	MASTER PACK	SHELF PACK
TJ924E	Replacement Jaw - End Cut, Fits item TBC924E	0734442097204	-	1



## REPLACEMENT STRAP SETS

ITEM NO.	DESCRIPTION	EAN	MASTER PACK	SHELF PACK
T914UEFGT	Replacement Strap Set, Fits 14" / 355mm Bolt Cutters	0734442097938	-	1
T918UEFGT	Replacement Strap Set, Fits 18" / 460mm Bolt Cutters	0734442098058	-	1
T924UEFGT	Replacement Strap Set, Fits 24" / 610mm Bolt Cutters	0734442098652	-	1
T930UEFGT	Replacement Strap Set, Fits 30" / 760mm Bolt Cutters	0734442110057	-	1
T936UEFGT	Replacement Strap Set, Fits 36" / 915mm Bolt Cutters	0734442114857	-	1
T942UEFGT	Replacement Strap Set, Fits 42" / 1070mm Bolt Cutters	0734442108979	-	1



## FASTENER KITS

ITEM NO.	DESCRIPTION	EAN	MASTER PACK	SHELF PACK
T914KIT	Fastener Kit for item T914H	0734442097945	-	1
T918KIT	Fastener Kit for item T918H	0734442089292	-	1
T924KIT	Fastener Kit for item T924H	0734442098669	-	1
T930KIT	Fastener Kit for item T930H	0734442104773	-	1
T936KIT	Fastener Kit for item T936H	0734442091455	-	1
T942KIT	Fastener Kit for item T942H	0734442108917	-	1
TBC914KIT	Fastener Kit for item TBC914H & TTBC914	0734442090977	-	1
TBC918KIT	Fastener Kit for item TBC918H & TTBC918	0734442090984	-	1
TBC924KIT	Fastener Kit for item TBC924H & TTBC924	0734442169673	-	1
TBC930KIT	Fastener Kit for item TBC930H & TTBC930	0734442010043	-	1
TBC936KIT	Fastener Kit for item TBC936H & TTBC936	0734442101444	-	1

### INCLUDES:

- 4 arm adjust screws
- 2 stud strap nuts
- 2 stud strap washers
- 1 handle connecting pin
- 1 handle connecting clip
- 2 handle connecting bolts,
- 2 handle connecting nuts
- 2 arm rivets
- 1 jaw center pin



### SNIPS AND SHEARS

IRWIN® Gilbow® snips and shears have a cutting capability much greater than the strength of the user. The original tin snips were first designed in 1924 and have dominated the sheet metal cutting industry to such an extent that today, snips and shears are referred to as 'Gilbows'.

#### GENERAL PURPOSE SNIPS



TG24514

<b>UNIQUE NON-SLIP JOINT</b> set and tested for a perfect cut. This should be re-adjusted only after sharpening <b>DOUBLE, HOLLOW GROUND BLADES</b> reduce friction for easier cutting <b>DROP-FORGED</b> carbon tool steel handles and blades <b>SAFETY STOP</b> prevents trapped fingers	ITEM NO.	DESCRIPTION	EAN	MASTER PACK	SHELF PACK
	TG2458	General Purpose Snips, 8" / 200mm	0734442188049	36	6
	TG24510	General Purpose Snips, 10" / 250mm	0734442188162	36	6
	TG24512	General Purpose Snips, 12" / 300mm	0734442188285	36	6
	TG24514	General Purpose Snips, 14" / 350mm	0734442188407	36	6

#### CURVED BLADE SNIPS

Designed to complement the General Purpose range, these snips will make tight radius cuts in a clockwise or anti-clockwise direction.



TG24612

ITEM NO.	DESCRIPTION	EAN	MASTER PACK	SHELF PACK
TG2468	Curved Blade Snips, 8" / 200mm	0734442189008	48	6
TG24610	Curved Blade Snips, 10" / 250mm	0734442189121	48	3
TG24612	Curved Blade Snips, 12" / 300mm	0734442189244	48	3

#### JEWELLERS' SNIPS

Short-bladed light-duty snips often used by jewellers, silversmiths and model makers.



TG56

ITEM NO.	DESCRIPTION	EAN	MASTER PACK	SHELF PACK
TG56	Jewellers' Snips, 7" / 175mm Straight Blade	0734442190202	24	6
TG056	Jewellers' Snips, 7" / 175mm Curved Blade	0734442187929	24	6

#### HEAVY-DUTY CRANKED HANDLE SHEARS

These crank-handled shears can be used for off-straight cutting. The G69 is right-hand cranked for working anti-clockwise and the G67 is left-hand cranked for working clockwise.



TG67

ITEM NO.	DESCRIPTION	EAN	MASTER PACK	SHELF PACK
TG67	Heavy-Duty Cranked Handle Snips, 11" / 175mm Left-Handed	0734442189367	36	6
TG69	Heavy-Duty Cranked Handle Snips, 11" / 175mm Right-Handed	0734442189480	36	6
TG691	Heavy-Duty Cranked Handle Snips, 14" / 350mm Right-Handed	0734442189602	36	6

#### MEDIUM-DUTY STRAIGHT HANDLE SHEARS

Used for straight cutting.



TG950

ITEM NO.	DESCRIPTION	EAN	MASTER PACK	SHELF PACK
TG950	Medium-Duty Straight Handle Snips, 12" / 300mm	0734442189725	36	6
TG69NB	Nut & Bolt for G67, G69, G950, G691	0734442195368	-	1

## AVIATION AND OFFSET SNIPS

IRWIN® Aviation and Offset Snips have precision formed blades for a longer cutting life; ergonomically designed over-moulded soft-grips for a perfect balance of comfort and performance in the hand, and a long-life torsion spring for a smooth and consistent cut.

SERRATED LOWER BLADE

INCREASED LENGTH OF CUT

IMPROVED BALANCED WEIGHT DISTRIBUTION

### AVIATION SNIPS

Serrated blade grips material for a smoother cut on thin material. Ideal for heating, air conditioning, gutter work and general industrial use.



DROP-RESISTANT PUSH-UP LATCH

PROTOUCH™ GRIPS

#### 1. SERRATED LOWER BLADE

For firmer action, smoother cut and no double marked edges

#### 2. PROTOUCH™ GRIPS

Moulded for superior comfort and control, resulting in less hand fatigue/stress

#### 3. INCREASED LENGTH OF CUT

For faster work (3.34cm length of cut)

#### 4. IMPROVED BALANCED WEIGHT DISTRIBUTION

For greater comfort

#### 5. DROP-RESISTANT PUSH-UP LATCH

For easy one-handed use that saves time and increases safety

#### 6. CUT CAPACITY OF 1.19 mm

For sheet metal and 0.84mm stainless steel

**ProTouch**  
GRIPS



10504309N



10504310N



10504311N

ITEM NO.	DESCRIPTION	EAN	MASTER PACK	SHELF PACK
10504309N	Aviation Snip 101, Left and Straight Cut	5706915043099	-	5
10504310N	Aviation Snip 102, Right and Straight Cut	5706915043105	-	5
10504311N	Aviation Snip 103, Straight and Wide Curves	5706915043112	-	5

### BULLDOG SNIPS

Short blades designed for more power when notching and trimming thicker material. 225mm long with a 1.9 cm length of cut. Cut capacity of 16g/1.52 mm sheet metal and 18g/1.19 mm stainless steel.

ITEM NO.	DESCRIPTION	EAN	MASTER PACK	SHELF PACK
10504313N	Bulldog Snip 105, Straight and Short Curves	5706915043136	-	5



10504313N





## OFFSET SNIPS

For straight or curved cuts. Keeps hands safely above the work surface. 240mm long with a 3.02 cm length of cut. Cut capacity of 18g / 1.19 mm sheet metal and 22g / 0.84 mm stainless steel.



10504315N



ITEM NO.	DESCRIPTION	EAN	MASTER PACK	SHELF PACK
10504315N	Offset Snip 20SL, Straight, Angles & Left Curves	5706915043150	-	5
10504316N	Offset Snip 20SR, Straight, Angles & Right Curves	5706915043167	-	5



10504316N



## EXTRA CUT SNIPS

Designed for numerous applications when a long cut in lightweight material is desired. Compound leverage design provides cuts up to 80mm.



10504314N



ITEM NO.	DESCRIPTION	EAN	MASTER PACK	SHELF PACK
10504314N	Extra Cut Snip 304 Cut Straight and Wide Curves	5706915043143	25	5

# WOODWORKING







In 1933, a young man by the name of Hans Schroder set up as a wholesaler in Copenhagen, Denmark. During the first few years he kept his focus on selling general hand tools, but in 1938 he started to also manufacture saws. Amongst his friends and business associates Hans Schroder was known simply as Jack, and before long, the "Jack" name had become synonymous with the production of high quality saws.

IRWIN® Jack® has been at the forefront of many advancements with the development of the market leading Jack® 880 now with upgraded ProTouch™ handle to compliment the recently upgraded universal triple ground tooth technology.

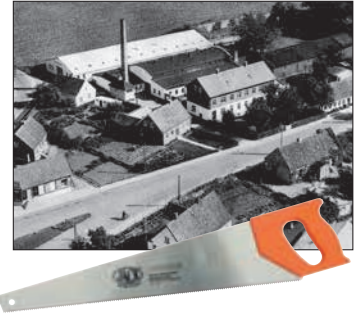

## Marples®

At the heart of quality craftsmanship lies the rich heritage of Marples® woodworking tools. Originating in 1828 in Sheffield, England, the Marples® brand has consistently stood for superior performance and ultimate precision in fine woodworking.

Founder William Marples came from a long lineage of master craftsmen in the joinery and edge tool trades, and after serving as an apprentice to his father he established William Marples and Sons Limited. Using only the finest materials Marples® had his name stamped into every product as a sign of his confidence in the quality and craftsmanship of each tool.



### HANDSAWS



### CHISELS



### WOODWORKING TOOLS





## PLUS 880 UNIVERSAL HANDSAW

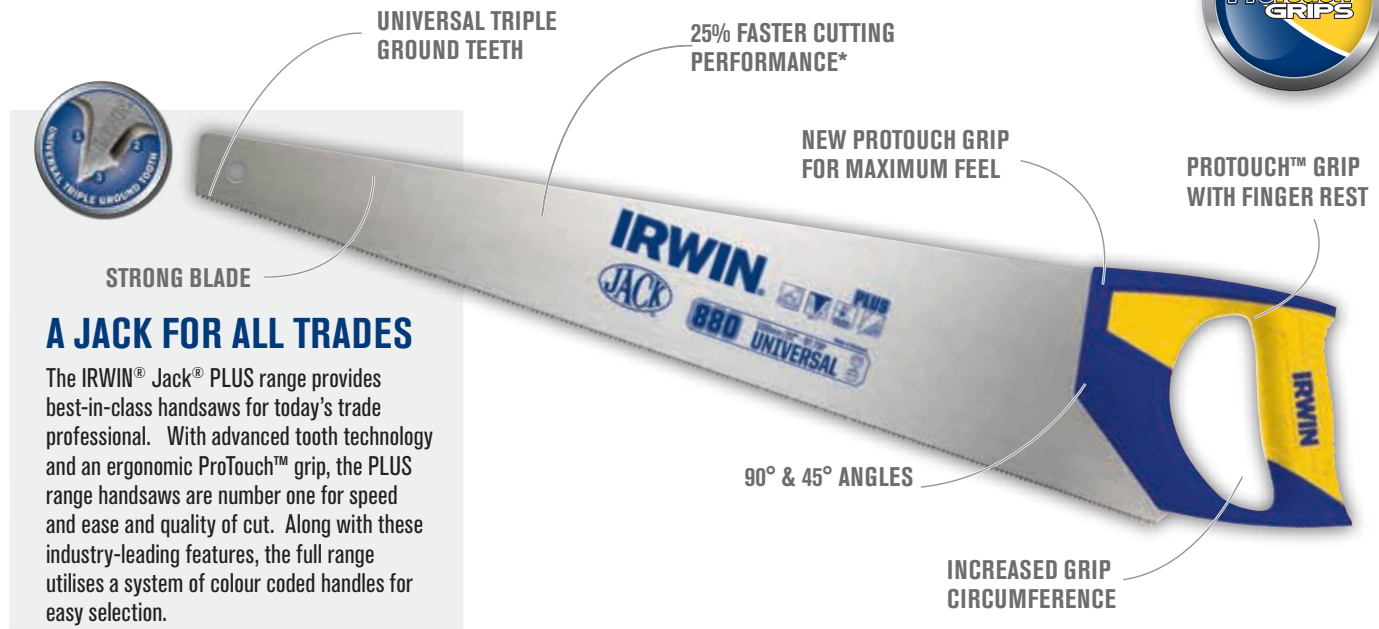

### A JACK FOR ALL TRADES

The IRWIN® Jack® PLUS range provides best-in-class handsaws for today's trade professional. With advanced tooth technology and an ergonomic ProTouch™ grip, the PLUS range handsaws are number one for speed and ease and quality of cut. Along with these industry-leading features, the full range utilises a system of colour coded handles for easy selection.



- 1. UNIVERSAL TRIPLE GROUND TEETH**  
Patented tooth grind designed to cut 25% faster  
Versatile, universal teeth cut most building materials
- 2. STRONG BLADE**  
High quality C75 steel is stable and ensures maximum power transfer with every stroke
- 3. PROTOUCH™ GRIP WITH FINGER REST**  
With three times more elastomer for maximum soft-feel and control
- 4. OPTIMISED HAND CAPACITY**  
Increased space for use with gloves and improved functionality
- 5. INCREASED GRIP CIRCUMFERENCE**  
For a sturdy and robust feel
- 6. 90° & 45° ANGLES**  
Integrated into handle for easy marking out

**25% FASTER\***

**ProTouch GRIPS**

### 880 UNIVERSAL HANDSAW

Ever-reliable cutting performance, improved handle design

ITEM NO.	DESCRIPTION	HANDLE COLOUR	EAN	MASTER PACK	SHELF PACK
10503621	Universal 880TG, 350mm / 14" 8T/9P		5706915936216	-	10
10503622	Universal 880TG, 400mm / 16" 8T/9P		5706915936223	-	10
10503623	Universal 880TG, 450mm / 18" 8T/9P		5706915936230	-	10
10503624	Universal 880TG, 500mm / 20" 8T/9P		5706915936247	-	10
10503625	Universal 880TG, 550mm / 22" 8T/9P		5706915936254	-	10

**NEW PROTOUCH GRIP** for maximum feel  
**25% FASTER CUTTING PERFORMANCE\***  
**FULL RANGE** of Fine, Universal, Coarse and Coated PLUS Handsaws Available  
**BLADE LENGTHS** 14" / 20" / 22"

\* vs previous, double ground version





## UNIVERSAL COATED

BLADE LENGTH - 22"



### FRICITION PTFE COATING

- A. Gives between 20 to 50% speed improvement (material dependent) when sawing
- B. Offers improved wear-resistance

ITEM NO.	DESCRIPTION	HANDLE COLOUR	EAN	MASTER PACK	SHELF PACK
1909432	Universal Coated 880TG, 550mm / 22" 8T/9P		5706919094325	-	10

## COARSE

BLADE LENGTH - 22"



### COARSE TEETH

- Patented Tooth Grind
- Double Ground
- 7 Teeth Per Inch

ITEM NO.	DESCRIPTION	HANDLE COLOUR	EAN	MASTER PACK	SHELF PACK
1912454	Crosscut / Coarse 660DG, 500mm / 20" 7T/8P		5706919124541	-	10
1912455	Crosscut / Coarse 770DG, 550mm / 22" 7T/8P		5706919124558	-	10
10503628	Crosscut / Coarse 660DG, 500mm / 20" 7T/8P		5706915936285	-	10
10503626	Crosscut / Coarse 770DG, 550mm / 22" 7T/8P		5706915936261	-	10

## FINE

BLADE LENGTH - 13" AND 22"



### FINE TEETH

- Patented Tooth Grind
- Double Ground
- 9 Teeth Per Inch

ITEM NO.	DESCRIPTION	HANDLE COLOUR	EAN	MASTER PACK	SHELF PACK
10503632	Ultra Fine 990, 325mm / 13" HP 12T/13P		5706915936322	-	10
1912456	Fine 990DG, 500mm / 20" HP 9T/10P		5706919124565	-	10
1909433	Ultra Fine 990, 325mm / 13" HP 12T/13P		5706919094332	-	10
10503630	Fine 990DG, 500mm / 20" HP 9T/10P		5706915936308	-	10
10503631	Fine 990DG 550mm / 22" 9T/10P		5706915936315	-	10

## XPERT HANDSAWS

The XPERT saw range takes wood cutting to new levels of comfort and performance - with a specific saw for every material and application.



Triple-Ground Teeth (TGT). This technology has been developed in collaboration with the research centre of the University of Newcastle. The TGT logo is the mark of quality for the IRWIN® Jack® tooth design.



10505538



10505542



10505550



### XPERT HANDSAWS

ITEM NO.	DESCRIPTION	HANDLE COLOUR	EAN	MASTER PACK	SHELF PACK
10505538	Universal Toolbox 15" / 375mm 8T/9P	Blue/Yellow	5706915055382	-	10
10505539	Universal 18" / 450mm 8T/9P	Blue/Yellow	5706915055399	-	4
10505540	Universal 20" / 500mm 8T/9P	Blue/Yellow	5706915055405	-	4
10505541	Universal 22" / 550mm 8T/9P	Blue/Yellow	5706915055412	-	4
10505555	Fine Toolbox 15" / 375mm 10T/11P	Blue/Yellow	5706915055559	-	10
10505556	Fine 20" / 500mm 10T/11P	Blue/Yellow	5706915055566	-	4
10505543	Fine 22" / 550mm 10T/11P	Blue/Yellow	5706915055436	-	4
10505542	Coarse with Gullets 22" / 550mm 8T/9P	Blue/Yellow	5706915055429	-	4
10503530	Coarse 20" / 500mm 3,5T/4P	Blue/Yellow	5715110475802	-	4
10503531	Coarse 24" / 600mm 3,5T/4P	Blue/Yellow	5715110427191	-	4
10505548	Light Concrete Hardpoint Teeth 28" / 700mm	Blue/Yellow	5706915055481	-	4
10505549	Light Concrete 1/2 Carbide Tipped 28" / 700mm	Blue/Yellow	5706915055498	-	4
10505550	Light Concrete FULL Carbide Tipped 28" / 700mm	Blue/Yellow	5706915055504	-	4

**TRIPLE-GROUND TEETH** for ultimate cutting performance  
**HIGH QUALITY C75 STEEL, 1mm RIGID BLADE** for maximum stability and power transfer  
**HARD POINT TEETH** stay sharp longer for extended life  
**WATER BASED LACQUER** gives four times better rust protection than traditional lacquer  
**SOFT-GRIP HANDLE** with finger guide for comfort in prolonged use  
**DEEP GULLETS** for enhanced performance and greater volume removal of waste material (Coarse saw only)  
**FINE NOSE TEETH** for easy start (Universal and Toolbox Saw only)

### XPERT COATED HANDSAWS

The Xpert range of low-friction PTFE coated handsaws from IRWIN® give between 20 to 50% speed improvement (material dependent) when sawing and also offer improved wear-resistance.

ITEM NO.	DESCRIPTION	HANDLE COLOUR	EAN	MASTER PACK	SHELF PACK
10505544	Universal Toolbox PTFE 15"/375mm 8T/9P	Blue/Yellow	5706915055443	-	10
10505545	Universal PTFE 20"/500mm 8T/9P	Blue/Yellow	5706915055450	-	4
10505546	Universal PTFE 22"/550mm 8T/9P	Blue/Yellow	5706915055467	-	4
10505602	Fine PTFE 20"/500mm 10T/11P	Blue/Yellow	5706915056020	-	4
10505603	Fine PTFE 22"/550mm 10T/11P	Blue/Yellow	5706915056037	-	4
10505547	Coarse with gullets PTFE 22"/550mm 8T/9P	Blue/Yellow	5706915055474	-	4



10505545

### XPERT BOWSAWS

IRWIN® offers the complete range of bowsaws and replacement blades for pruning and garden work. Select from hard point and precision filed blades that give outstanding cutting performance, whether it's trimming storm-damaged trees, pruning shrubs, bushes or cutting firewood.

ITEM NO.	DESCRIPTION	EAN	MASTER PACK	SHELF PACK
<b>FRAMES</b>				
TXP1624533000	Bowsaw - Green Wood 21" / 533 mm	5706915000269	-	5
TXP1124610000	Bowsaw - Green Wood 24" / 610 mm	5706915000207	-	5
TXP1124762000	Bowsaw - Green Wood 30" / 762 mm	5706915000221	-	5
<b>BLADES</b>				
TXP3011300000	Bowsaw Blade - Dry Wood 12" / 300 mm	5715110480066	-	10
TXP3020533000	Bowsaw Blade - Dry Wood 21" / 533 mm	5715110480189	-	10
TXP3020610000	Bowsaw Blade - Dry Wood 24" / 610 mm	5715110480219	-	10
TXP3020762000	Bowsaw Blade - Dry Wood 30" / 762 mm	5715110480240	-	10
TXP3024533000	Bowsaw Blade - Green Wood 21" / 533 mm	5715110480271	-	10
TXP3024610000	Bowsaw Blade - Green Wood 24" / 610 mm	5715110480332	-	10
TXP3024762000	Bowsaw Blade - Green Wood 30" / 762 mm	5715110480301	-	10



TXP1124762000



TXP3011300000



TXP3020533000



TXP3024533000



## EVO HANDSAWS

The unique handle-to-blade relationship of the EVO handsaw overcomes traditional design limitations and maximises how the user interacts with the handsaw. With an innovative tooth design and superior ergonomics, the holistic product design optimises handle position (height and angle) against the tooth line. EVO covers virtually all user needs.

**HIGH ANGLED NOSE** increases blade stability  
**HARD POINT TEETH (HP)** stay sharp 6-8 times longer than non-hardened teeth  
**OPTIMISED TOOTH DESIGN & SET** provides maximum versatility, Speed of cut & quality of cut  
**HIGH QUALITY C75 STEEL BLADE** ensures maximum stability and power transfer  
**OPTIMISED PRODUCT DESIGN** for universal usage and highest versatility  
**MAXIMUM BLADE USAGE** allows up to 100% blade usage  
**FLUSH CUTTING** to cut off at surface level  
**COMFORT GRIP** light and strong ultrasonic welded soft-grip handle for maximum grip and comfort  
**90° & 45°** for marking out  
**FINGER-REST** for maximum control



ITEM NO.	DESCRIPTION	HANDLE COLOUR	EAN	MASTER PACK	SHELF PACK
10507858	EVO Handsaw Universal, 525mm 10T/11P		5706915078589	-	10
10507860	EVO Handsaw Universal - Short, 425mm 10T/11P		5706915078602	-	10
1965487	EVO Handsaw Universal Coated 485mm 10T/11P		5706919654871	-	10

## SPECIALTY SAWS

IRWIN® Specialty saws help construction professionals effectively carry out trade specific jobs like cutting openings in gypsum board.



10503534



10505707



10503533



10505705



T106150



10503532

ITEM NO.	DESCRIPTION	EAN	MASTER PACK	SHELF PACK
10505705	ProTouch Jab Saw, 7T/8P	5706915057058	24	4
T106150	Standard Jab Saw, 7T/8P	5715110421601	-	20
10505707	Protouch Dovetail Saw with reversible handle, 10"/254mm 13T/14P	5706915057072	24	4
10503532	Keyhole/Pad Saw, 12"/300mm	5706915035322	-	4
10503533	Floorboard/Veneer, 13"/325mm	5706915035339	-	4
10507424	Tenon, 10"/250mm 12T/13P	5706915074246	-	4
10503534	Tenon, 12"/300mm 12T/13P	5706915035346	-	4
10503535	Tenon, 14"/350mm 12T/13P	5706915035353	-	4

## PULL SAWS

IRWIN® Pull Saws are rapidly becoming an essential tool for both the specialist woodworker and for carpenters and re-modellers. The products offers a very thin blade that is flexible for flush and difficult cuts.



10505163



10505164



10505165

ITEM NO.	DESCRIPTION	EAN	MASTER PACK	SHELF PACK
10505162	Pull Saw Carpenter 12"/300mm, 14TPI	5706915051629	-	4
10505163	Pull Saw Extra Fine Cut (with spine), 19TPI	5706915051636	-	4
10505164	Pull Saw Double Edge (rip/cross-cut), 7/17TPI	5706915051643	-	4
10505165	Pull Saw Mini Dovetail/Detail Saw, 22TPI	5706915051650	-	4

## PRUNING SAWS



TNA2059343000

ITEM NO.	DESCRIPTION	EAN	MASTER PACK	SHELF PACK
TNA2059343000	Pruning Saw - Straight	5715110421632	-	6
TNA2072330000	Pruning Saw - Curved	5715110421663	-	6

## COMBI SAW

IRWIN® Jack® Combi Saw comes with a wood cutting bowsaw blade and a Bi-Metal cutting hacksaw blade making this tool universal for all cutting applications.



TXP1211300000

ITEM NO.	DESCRIPTION	EAN	MASTER PACK	SHELF PACK
TXP1211300000	Combi Saw, 12"/300 mm	5706915000122	-	10

# WOODWORKING



# CHISELS

IRWIN® woodworking tools embody a long tradition of craftsmanship and Marples® chisels remain the finest on the market, recognised by professionals as setting the standard for all others. With many unique features developed through continuing innovation, our comprehensive range of tough, dependable chisels will tackle the most intricate or demanding job effortlessly.

**BEST IN CATEGORY STEEL QUALITY**

**BLADE HARDENED AND TEMPERED**

**PROTOCH™ OVER-MOULD GRIP**

**EXTRA LARGE STRIKE CAP**

**SPLITPROOF ACETATE HANDLE**

**MS750 HIGH-IMPACT CHISELS**

- BEST IN CATEGORY STEEL QUALITY**  
For improved sharpness and edge retention
- BLADE HARDENED AND TEMPERED**  
For long chisel life
- FULLY FORGED STEEL CORE**  
To better transfer energy from handle to blade
- PROTOCH™ OVER-MOULD GRIP**  
For added comfort
- SPLITPROOF ACETATE HANDLE**  
For superior durability
- EXTRA LARGE STRIKE CAP**  
For use with hammers at different angles

### MS750 SINGLES

ITEM NO.	DESCRIPTION	EAN	MASTER PACK	SHELF PACK
10501685	MS750, 3mm	0734442201250	48	4
	MS750, 6mm	0734442201151	48	4
	MS750, 8mm	5706915016741	48	4
	MS750, 10mm	0734442201168	48	4
	MS750, 12mm	5706915016765	48	4
	MS750, 14mm	5706915016789	48	4
	MS750, 15mm	5706915016796	48	4
	MS750, 16mm	0734442201267	48	4
	MS750, 18mm	5706915016819	48	4
	MS750, 20mm	5706915016833	48	4
	MS750, 22mm	5706915016840	48	4
	MS750, 25mm	0734442201199	48	4
	MS750, 26mm	5706915016864	48	4
	MS750, 28mm	5706915016871	48	4
	MS750, 30mm	5706915016888	48	4
	MS750, 32mm	0734442201205	48	4
10503733	MS750, 35mm	5706915016901	48	4
	MS750, 38mm	0734442201212	24	2
	MS750, 51mm	0734442201274	24	2

### MS750 SETS

ITEM NO.	DESCRIPTION	EAN	MASTER PACK	SHELF PACK
10504711	MS750, 3 pcs, 6, 12, 20 mm, Wallet	5706915047110	16	4
10504712	MS750, 3 pcs, 10, 15, 20 mm, Wallet	5706915047127	16	4
10503733	MS750, 6 pcs, 6, 10, 15, 20, 25, 35 mm, in Wooden Box	5706915037333	5	1



## MS751 FIRMER CHISEL

The MS751 Firmer chisel has a blade with a rectangular cross-section. This means that it is stronger and can be used for heavier work and cuts on a front edge.



10501768

ITEM NO.	DESCRIPTION	EAN	MASTER PACK	SHELF PACK
10501768	MS751, 1-1/8" / 28mm	5706915017687	48	4

## MS500 ALL-PURPOSE CHISELS WITH STRIKING CAP



10501708

## MS500 SINGLES

ITEM NO.	DESCRIPTION	EAN	MASTER PACK	SHELF PACK
10501698	MS500, 6mm	5706915016987	48	4
10501699	MS500, 8mm	5706915016994	48	4
10501700	MS500, 10mm	5706915017007	48	4
10501701	MS500, 12mm	5706915017014	48	4
10501703	MS500, 14mm	5706915017038	48	4
10501704	MS500, 15mm	5706915017045	48	4
10501705	MS500, 16mm	5706915017052	48	4
10503666	MS500, 18mm	5706915036664	48	4
10501707	MS500, 20mm	5706915017076	48	4
10503667	MS500, 22mm	5706915036671	48	4
10501708	MS500, 25mm	5706915017083	48	4
10501709	MS500, 26mm	5706915017090	48	4
10503668	MS500, 28mm	5706915036688	48	4
10501710	MS500, 30mm	5706915017106	48	4
10503669	MS500, 32mm	5706915036695	48	4
10503423	MS500, 35mm	5706915034233	48	4
10503670	MS500, 38mm	5706915036701	24	2
10503425	MS500, 51mm	5706915034257	24	2

**BEST IN CATEGORY STEEL QUALITY** for improved sharpness and edge retention  
**BLADE HARDENED AND TEMPERED** for long chisel life  
**PROTOUCH GRIP** for added comfort  
**DURABLE HANDLE** to withstand tradesmen abuse  
**LARGE STRIKE CAP** to withstand hammer impacts

## MS500 SETS

ITEM NO.	DESCRIPTION	EAN	MASTER PACK	SHELF PACK
10503835	MS500, 3 pcs, 6, 12, 20mm, Wallet	5706915038354	16	4
10503836	MS500, 3 pcs, 10, 15, 20mm, Wallet	5706915038361	16	4
10503429	MS500, 5 pcs, 6, 10, 15, 20, 25, Wallet	5706915034295	16	8
10503876	MS500, 5 pcs, 6, 10, 16, 20, 26, Wallet	5706915038767	16	8
10503431	MS500, 6 pcs, 6, 10, 12, 16, 20, 26mm in Wooden Box	5706915034318	5	1
10503541	MS500, 6 pcs, 6, 10, 15, 20, 25, 35mm in Wooden Box	5706915035414	5	1



10503835



10503429



10503431



### M444 BLUE-CHIP BEVEL EDGE CHISELS



### M444 SINGLES

**BEST IN CATEGORY STEEL QUALITY** for improved sharpness and edge retention  
**BLADE HARDENED AND TEMPERED** for long chisel life  
**CONTOURED HANDLE** provides added control  
**STRONG HANDLE** for use with hand or mallet

ITEM NO.	DESCRIPTION	EAN	MASTER PACK	SHELF PACK
TM44418	M444, 3mm	0734442196440	24	6
TM44414	M444, 6mm	0734442196563	24	6
TM44438	M444, 10mm	0734442196686	24	6
TM44412	M444, 13mm	0734442196808	24	6
TM44458	M444, 16mm	0734442196921	24	6
TM44434	M444, 19mm	0734442197041	24	6
TM4441	M444, 25mm	0734442197164	24	6
TM444114	M444, 32mm	0734442197287	24	6
TM444112	M444, 38mm	0734442197409	24	6
TM4442	M444, 51mm	0734442201960	24	6

### M444 SETS



TM444S6

ITEM NO.	DESCRIPTION	EAN	MASTER PACK	SHELF PACK
TM444S3	M444, 3 pcs Set - 13, 19, 25mm in clamshell	0734442197508	16	4
TM444S4	M444, 4 pcs Set - 6, 13, 19, 25mm in clamshell	0734442197522	16	4
TM444S5	M444, 5 pcs Set - 6, 10, 13, 19, 25mm in clamshell	0734442197645	16	4
TM444S6	M444, 6 pcs Set - 6, 10, 13, 19, 25, 32mm in wooden box	0734442197652	5	1



TM444S3



TM444S4



TM444S5

### CHISEL SHARPENING SET



ITEM NO.	DESCRIPTION	EAN	MASTER PACK	SHELF PACK
10507932	3 pcs Sharpening Set includes Stone, Guide and Oil	5706915079326	16	4

## SQUARES AND SLIDING BEVELS

Sliding bevels are precision tools and are used for checking the accuracy and marking of angles. Tri Squares are designed to check and mark out 90° angles.

### TRI & MITRE SQUARES - METRIC

ITEM NO.	DESCRIPTION	EAN	MASTER PACK	SHELF PACK
10503543	Tri & Mitre Square 250mm	5706915035438	-	4
10503544	Tri & Mitre Square 300mm	5706915035445	-	4
10503545	Tri & Mitre Square 350mm	5706915035452	-	4

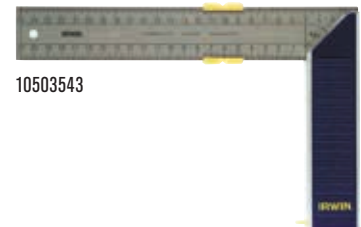

### TRI & MITRE SQUARES - IMPERIAL

ITEM NO.	DESCRIPTION	EAN	MASTER PACK	SHELF PACK
TM22006	Tri Square with Brass Plate 6"	0734442231004	36	6
TM220012	Tri Square 12"	0734442231240	36	6
TMR22089	Tri Square 9"	0734442231486	48	6
TMR2210	Mitre Square 10"	0734442231608	36	1



### SLIDING BEVELS - METRIC

ITEM NO.	DESCRIPTION	EAN	MASTER PACK	SHELF PACK
10503546	Sliding Bevel 250mm	5706915035469	-	4
10503547	Sliding Bevel 300mm	5706915035476	-	4



### SLIDING BEVELS - IMPERIAL

ITEM NO.	DESCRIPTION	EAN	MASTER PACK	SHELF PACK
TM2226	Sliding Bevel - Brass & Rosewood, 9"	0734442231844	48	4
TM22261012	Sliding Bevel - Brass & Rosewood, 10-1/2"	0734442071167	48	4



## GENERAL WOODWORKING TOOLS

These tools are an essential part of any workshop or toolbox. They all contribute to the final fit of the timber to ensure the highest quality finish.

### BRADAWLS

ITEM NO.	DESCRIPTION	EAN	MASTER PACK	SHELF PACK
TM1838W	Bradawl Wooden Handled	0734442234722	72	12



### MORTICE, MARKING AND CUTTING GAUGES

ITEM NO.	DESCRIPTION	EAN	MASTER PACK	SHELF PACK
TM2153	Mortice & Marking Gauge	0734442232322	24	4
TM2154	Mortice & Marking Gauge with thumbscrew slide	0734442232445	12	1
TMR2049	Marking Gauge	0734442231967	48	4
TM2083	Cutting Gauge	0734442232209	24	4



### CABINET SCRAPERS

These versatile tools are used for shaping and finishing work.

ITEM NO.	DESCRIPTION	EAN	MASTER PACK	SHELF PACK
TM2450	Cabinet Scraper, 5" x 2-1/2" / 125mm x 64mm	0734442235309	-	6
TM2451	Cabinet Scraper, 6" x 3" / 150mm x 75mm	0734442235316	-	6





# PLANES & PLANE CUTTERS

IRWIN® Record® bring decades of experience, well proven design and advanced production techniques to produce this fine range of woodworking planes and cutters.



### BENCH PLANES

Smoothing Plane used for smoothing and final finishing. Jack planes are used for the preliminary squaring of rough timber, and are the general workhorses for stock removal. Fore or jointer planes are used for removing the roughness and unevenness on long surfaces prior to smoothing.

#### 1. HIGH-QUALITY

Cast grey iron body with precision machined base

#### 2. RAZOR SHARP

Carbon steel cutting iron

#### 3. ROBUST LEVER CAP

Has three pressure points and brass locking nut for secure location of the cutting iron

#### 4. FINE ADJUSTMENT

Is controlled by a brass adjusting nut and lateral adjusting lever



ITEM NO.	DESCRIPTION	EAN	MASTER PACK	SHELF PACK
T04	Smoothing Plane, 9-3/4" - 2" / 50mm, Wooden Handle	0734442053408	24	1
TSP4	Smoothing Plane, 9-3/4" - 2" / 50mm, Plastic Handle	0734442165729	48	4
T05	Jack Plane, 14" - 2" / 50mm, Wooden Handle	0734442536482	24	1
TSP5	Jack Plane, 14" - 2" / 50mm, Plastic Handle	0734442165910	48	4
T07	Jointer Plane, 22" - 2-3/8" / 60mm - length 550mm, Wooden Handle	0734442054009	12	1

### REBATE PLANE

Rebate plane has two cutter positions, one for normal rebating work and a forward position for planing into corners and difficult positions.



ITEM NO.	DESCRIPTION	EAN	MASTER PACK	SHELF PACK
T778	Rebate Plane, Length 8-1/2" - Cuts Rebates up to 1-1/2" / 38mm	0734442559252	12	1

### BLOCK PLANES

Block planes are fully adjustable for the depth of cut with mouth adjustments for coarse or fine work. Low angle block plane is specially made to deal with plastic, laminates, and other man-made materials, besides wood.



ITEM NO.	DESCRIPTION	EAN	MASTER PACK	SHELF PACK
T06012	Block Plane, 6" (42mm) - 1-5/8" 12-1/2° - 20° low angle	0734442552086	24	4
T0912	Block Plane, 6" (42mm) - 1-5/8" 12-1/2°	0734442548430	24	4

### SPOKESHAVES

The spokeshave is used for chamfering and shaping - flat-faced for convex surfaces and round-faced for concave surfaces.



ITEM NO.	DESCRIPTION	EAN	MASTER PACK	SHELF PACK
TA151	Spokeshave, Flatface Length 10" / 54mm	0734442056164	24	4
TA151R	Spokeshave, Roundface Length 10" / 54mm	0734442056287	24	4

### REPLACEMENT PLANE CUTTERS



ITEM NO.	DESCRIPTION	EAN	MASTER PACK	SHELF PACK
TSI2	Plane Cutter, 2" / 50mm for 04, 05, SP4 & SP5	0734442056522	24	6
TSI238	Plane Cutter, 2-3/8" / 60mm for 06, 07	0734442056645	24	6
T0220D	Plane Cutter, 2-3/8" / 46mm for 09-1/2 & 060-1/2	0734442057963	24	1
T778D	Plane Cutter, for 778	0734442058809	24	1
TA151B	Spokeshave Cutter, 2-1/8" / 54mm	0734442058922	24	1



# WORKHOLDING





## QUICK-GRIP®

In 1986 Joe Sorensen, an air boat builder in Nebraska, USA was looking for a better way to hold down his steel panels as the clamps he was using twisted the thin steel as he worked.

With a good idea for a new style of clamping, the concept for a pistol grip one-handed bar clamp was born. This revolutionary tool was quickly patented and brought to market in 1989 with a full line of clamps under the QUICK-GRIP® brand name. The line was later extended from the Original clamp to the Micro, Mini, Handi, Quick-Change, and more recently the XP clamp.

Since the launch, IRWIN® Quick-Grip® has become the world leader in one-handed bar clamps and is the industry standard which has changed the way tradespeople do their jobs, greatly improving their ability and efficiency on the job.



## Record®

Originally established in 1898 in the South Yorkshire city of Sheffield in the UK. The Record Tools Factory was swiftly able to make a long lasting contribution to the worldwide reputation of the region for the manufacture of high quality steel and castings.

The Record® brand name was introduced in 1909 and by the 1920's the product range had expanded into Vices, Planes, Clamps and Pipe Wrenches enabling the business to grow rapidly in the UK and many overseas markets.

Today, IRWIN® Record® continues excelling by sticking to the traditional values set by its founders, producing tools that are highly valued amongst professional users for quality and durability that remains strong today.



### QUICK CLAMPS



### STEEL CLAMPS



### VICES





## INTRODUCING THE NEXT GENERATION IN CLAMPING TOOLS

The new IRWIN® QUICK-GRIP® One-Handed Bar Clamp range allows end-users to be even more productive on the job. The new heavy-duty and medium-duty clamps feature a Quick-Change™ button for fast conversion to a spreader and for ease-of-use with a new line of One-Handed Bar Clamp Accessories.

These new IRWIN® QUICK-GRIP® One-Handed Bar Clamp Accessories provide added versatility and functionality to one-handed bar clamps—allowing users to DO MORE WITH QUICK-GRIP™.

## HEAVY-DUTY ONE-HANDED BAR CLAMPS

**NEW**

NEW REMOVABLE SWIVEL JAWS & NON-MARRING PADS

NEW QUICK-CHANGE™ BUTTON

HEAT-TREATED, BLACK OXIDE CARBON STEEL I-BEAM

ADJUSTABLE FOOT

ONE-HANDED QUICK-RELEASE TRIGGER

**HEAVY-DUTY ONE-HANDED BAR CLAMPS**

The IRWIN® QUICK-GRIP® Heavy-Duty One Handed Bar Clamp evenly distributes up to 272kg (600 lbs.) of sustained clamping pressure and is one of the top performing One-Handed Bar Clamps available. Ideal for heavy-duty applications such as installation, demolition and rough glue-up.

- 1. NEW QUICK-CHANGE™ BUTTON**  
Provides easy removal of jaws for accessory installation or conversion to a spreader
- 2. NEW REMOVABLE SWIVEL JAWS & NON-MARRING PADS**  
Full-faced pads deliver even distribution of clamping force
- 3. ONE-HANDED QUICK-RELEASE TRIGGER**  
New grip and trigger design provides simple, one-handed operation
- 4. HEAT-TREATED, BLACK OXIDE CARBON STEEL I-BEAM**  
Support added pressure with less bend and flex for superior durability
- 5. ADJUSTABLE FOOT**  
Provides added support allowing clamp to sit upright on table or work surface

**272 kg**  
SUSTAINED CLAMPING FORCE

ITEM NO.	DESCRIPTION	SPREADING CAPACITY	THROAT DEPTH	EAN	MASTER PACK	SHELF PACK
10505942	150mm (6") Heavy-Duty Bar Clamp/Spreader	235mm - 378mm 9-1/4" - 14-7/8"	92mm / 3-5/8"	5706915059427	-	2
10505943	300mm (12") Heavy-Duty Bar Clamp/Spreader	235mm - 530mm 9-1/4" - 20-7/8"	92mm / 3-5/8"	5706915059434	-	2
10505944	450mm (18") Heavy-Duty Bar Clamp/Spreader	235mm - 683mm 9-1/4" - 26-7/8"	92mm / 3-5/8"	5706915059441	-	2
10505945	600mm (24") Heavy-Duty Bar Clamp/Spreader	235mm - 835mm 9-1/4" - 32-7/8"	92mm / 3-5/8"	5706915059458	-	2
10505946	900mm (36") Heavy-Duty Bar Clamp/Spreader	235mm - 1140mm 9-1/4" - 44-7/8"	92mm / 3-5/8"	5706915059465	-	2
10505947	1250mm (50") Heavy-Duty Bar Clamp/Spreader	235mm - 1496mm 9-1/4" - 58-7/8"	92mm / 3-5/8"	5706915059472	-	2



# MEDIUM-DUTY ONE-HANDED BAR CLAMPS

**NEW**

NEW QUICK-CHANGE™ BUTTON

NEW REMOVABLE SWIVEL JAWS & NON-MARRING PADS



HEAT-TREATED, BLACK OXIDE CARBON STEEL I-BEAM

ONE-HANDED QUICK-RELEASE TRIGGER

## MEDIUM-DUTY ONE-HANDED BAR CLAMPS

The IRWIN® QUICK-GRIP® Medium-Duty One-Handed Bar Clamp evenly distributes up to 136kg (300 lbs) of sustained clamping force. Ideal for temporary hold-down, quick clamping applications



- 1. NEW QUICK-CHANGE™ BUTTON**  
Provides easy removal of jaws for accessory installation or conversion to a spreader
- 2. NEW REMOVABLE SWIVEL JAWS & NON-MARRING PADS**  
Full-faced pads deliver even distribution of clamping force
- 3. ONE-HANDED QUICK-RELEASE TRIGGER**  
New grip and trigger design provides simple, one-handed operation
- 4. HEAT-TREATED, BLACK OXIDE CARBON STEEL I-BEAM**  
Support added pressure with less bend and flex for superior durability

**136 kg**  
SUSTAINED CLAMPING FORCE



T506QCEL7

ITEM NO.	DESCRIPTION	SPREADING CAPACITY	THROAT DEPTH	EAN	MASTER PACK	SHELF PACK
T506QCEL7	150mm (6") Medium-Duty Bar Clamp/Spreader	200mm - 340mm 7-7/8" - 13-3/8"	81 mm / 3-3/16"	5706915000061	-	5
T512QCEL7	300mm (12") Medium-Duty Bar Clamp/Spreader	200mm - 590mm 7-7/8" - 19-3/8"	81 mm / 3-3/16"	5706915000078	-	5
T518QCEL7	450mm (18") Medium-Duty Bar Clamp/Spreader	200mm - 645mm 7-7/8" - 25-3/8"	81 mm / 3-3/16"	5706915000085	-	5
T524QCEL7	600mm (24") Medium-Duty Bar Clamp/Spreader	200mm - 795mm 7-7/8" - 31-3/8"	81 mm / 3-3/16"	5706915000092	-	5
T536QCEL7	900mm (36") Medium-Duty Bar Clamp/Spreader	200mm - 1120mm 7-7/8" - 43-3/8"	81 mm / 3-3/16"	5706915000108	-	5

## MINI ONE-HANDED BAR CLAMP

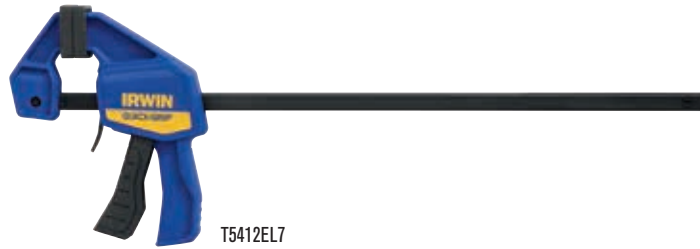

T5412EL7

**NEW**

ITEM NO.	DESCRIPTION	THROAT DEPTH	EAN	MASTER PACK	SHELF PACK
T546EL7	150mm (6") Mini Clamp	2-7/16" / 62mm	5715110790585	-	5
T5462EL7	150mm (6") Mini Clamp - 2 Pack	2-7/16" / 62mm	5715110790592	-	5
T5412EL7	300mm (12") Mini Clamp	2-7/16" / 62mm	5715110790622	-	5
T54122EL7	300mm (12") Mini Clamp - 2 Pack	2-7/16" / 62mm	5715110790639	-	5

**EVENLY DISTRIBUTES UP TO 63kg (140 lbs.)** of sustained clamping force  
**IDEAL FOR LIGHT-DUTY APPLICATIONS** like woodworking and a variety of smaller projects  
**NON-MARRING FULL-FACE PADS** protect work surfaces  
**ONE-HANDED QUICK-RELEASE™ TRIGGER**

## MICRO ONE-HANDED BAR CLAMP



T53006EL7

**NEW**

ITEM NO.	DESCRIPTION	THROAT DEPTH	EAN	MASTER PACK	SHELF PACK
T53006EL7	115mm (4.5") Micro Clamp	1-3/16" / 30mm	5715110790547	-	10
T530062EL7	115mm (4.5") Micro Clamp - 2 Pack	1-3/16" / 30mm	5715110801021	-	5

**SPECIALLY DESIGNED** for home, craft and hobby use providing 15kg (35 lbs.) of clamping pressure  
**IDEAL FOR DELICATE WORK** requiring light clamping pressure  
**NON-MARRING FULL-FACE PADS** protect work surfaces  
**ONE-HANDED QUICK-RELEASE™ TRIGGER**

## HANDI CLAMPS

Strong ratcheting mechanism provides variable clamping pressure 20kg (44 lbs). Quick-Release trigger allows for fast and easy positioning and release. The ideal clamp for jobs in workshop, house and garden. Specially designed jaws hold odd-shaped workpieces.

ITEM NO.	DESCRIPTION	THROAT DEPTH	EAN	MASTER PACK	SHELF PACK
T59100ECD	38mm (1-1/4") Handi Clamp	1-1/2" / 38mm	0038548591001	-	20
T59200ECD	50mm (2") Handi Clamp	2" / 50mm	0038548592008	-	12
T59400ECD	100mm (4") Handi Clamp	4" / 100mm	0038548594002	-	10



T59200ECD

## SPRING CLAMPS

High-tech resin construction provides strength and durability. Best for simple and convenient light clamping crafts.

ITEM NO.	DESCRIPTION	THROAT DEPTH	EAN	MASTER PACK	SHELF PACK
T58100EL7	25mm (1") Spring Clamp	1-1/2" / 38mm	0038548581019	50	10
T58200EL7	50mm (2") Spring Clamp	2" / 50mm	0038548582016	50	10
T58300EL7	75mm (3") Spring Clamp	3" / 75mm	0038548582016	25	5



T58200EL7

## REPLACEMENT PADS

ITEM NO.	DESCRIPTION	EAN	MASTER PACK	SHELF PACK
1826576	XP Pads, 2 per Pack (Previous Model HD Clamp)	0038548998640	-	5
1826577	Quick-Change Pads, 2 per Pack (Previous Model MD Clamp)	0038548998657	-	5
1826578	Mini Replacement Pads, 4 per Pack	0038548998664	-	5
1826579	Handi Clamp Replacement Pads, 6 per Pack	0038548998671	-	5



1826576



1826577





### ONE-HANDED BAR CLAMP ACCESSORIES

The new IRWIN® QUICK-GRIP® One-Handed Bar Clamps are designed to be compatible with the new line of One-Handed Bar Clamp Accessories. The chart below outlines which accessories fit which of the newly designed clamps and which accessories can also be used with the previous generation of IRWIN® QUICK-GRIP® One-Handed Bar Clamps.

# DO MORE WITH QUICK-GRIP™



Edge Clamping



Wider Clamping Pressure



Corner Clamping



Table Clamping

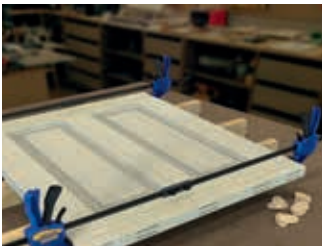

Coupling (Medium-Duty)



Coupling (Heavy-Duty)



Deck Building



Parallel Clamping

#### EDGE CLAMP



1988919

ITEM NO.	DESCRIPTION	APPLICATION INFORMATION	EAN	MASTER PACK	SHELF PACK
1988919	Edge Clamp	Converts One-Handed Bar Clamp into an edge clamp for easy clamping of trim and edging	5706919889198	40	5

#### COUPLERS



1988920



1988931

ITEM NO.	DESCRIPTION	APPLICATION INFORMATION	EAN	MASTER PACK	SHELF PACK
1988920	Medium-Duty Clamp Coupler	Connects the bars of two shorter One-Handed Bar Clamps to create one longer clamp	5706919889204	40	5
1988931	Heavy-Duty Clamp Coupler		5706919889310	40	5

#### HOLD DOWN JIG



1988932

ITEM NO.	DESCRIPTION	APPLICATION INFORMATION	EAN	MASTER PACK	SHELF PACK
1988932	Hold Down Jig	Converts One-Handed Bar Clamp into a table clamp	5706919889327	40	5

#### WIDE PADS



1988933

ITEM NO.	DESCRIPTION	APPLICATION INFORMATION	EAN	MASTER PACK	SHELF PACK
1988933	Wide Pads	Double the width of standard pads to distribute clamping force onto a wider surface area	5706919889334	40	5

## CORNER CLAMP

ITEM NO.	DESCRIPTION	APPLICATION INFORMATION	EAN	MASTER PACK	SHELF PACK
1988935	Corner Clamp Pads	Converts One-Handed Bar Clamp into a corner clamp for easy clamping of 90° angles	5706919889358	40	5



## DECK TOOL

ITEM NO.	DESCRIPTION	APPLICATION INFORMATION	EAN	MASTER PACK	SHELF PACK
1988934	Deck Tool Kit	Converts One-Handed Bar Clamp into a deck clamp for easy, accurate spacing, aligning and holding during deck building	5706919889341	40	5







## CLAMP STAND

ITEM NO.	DESCRIPTION	APPLICATION INFORMATION	EAN	MASTER PACK	SHELF PACK
1988936	Clamp Stand	Converts One-Handed Bar Clamp for level clamping; ideal for parallel clamping applications such as frames, caseworks and drawers	5706919889365	40	5









## ACCESSORY SELECTION GUIDE

SKU Code	Accessories	NEW	NEW	Quick-Change	XP
		Medium-Duty 	Heavy-Duty 		
1988919	Edge Clamp	✓		✓	
1988920	Medium-Duty Clamp Coupler	✓		✓	
1988931	Heavy-Duty Clamp Coupler		✓		✓
1988932	Hold Down Jig	✓	✓	✓	✓
1988933	Wide Pads	✓	✓		
1988934	Deck Tool Kit	✓			
1988935	Corner Clamp Pads	✓	✓		
1988936	Clamp Stand	✓	✓	✓	✓



### CLAMPING TOOLS SELECTION GUIDE

CLAMPS & SPECS	ONE-HANDED BAR CLAMPS				HANDI / SPRING CLAMPS	
	 MICRO	 MINI	 MEDIUM-DUTY	 HEAVY-DUTY	 HANDI-CLAMP	 SPRING CLAMP
<b>Holding Force:</b>	15 kg / 35 lbs	63 kg / 140 lbs	136 kg / 300 lbs	272 kg / 600 lbs	20 - 40 kg	15 - 30 kg
<b>Clamp Capacity:</b>	115 mm	150 - 300 mm	150 - 900 mm	150 - 1250 mm	30 - 100 mm	30 - 75 mm
<b>Throat Depth:</b>	30mm (1-3/16")	62mm (2-7/16")	81 mm (3-3/16")	92mm (3-5/8")	38 - 100 mm	30 - 75 mm
<b>Spreading Capacity:</b>	-	-	200mm - 1120mm (7-7/8" - 43-3/8")	235mm - 1496mm (9-1/4" - 58-7/8")	-	-
<b>Crafts / light-duty clamping</b>	●	●	◐		◐	○
<b>Temporary hold-down quick clamping</b>	●	●	●	●	◐	○
<b>Flat panels / Solid edge wood glue-up / Deep-reach clamping</b>				◐		
<b>Irregular shape / Multiple surface Corner joining</b>			◐	◐		
<b>Installation / Demolition / Heavy-duty clamping</b>			◐	●		

○ = Good    ◐ = Better    ● = Best



# WORKHOLDING



### HEAVY-DUTY CLAMPING

IRWIN® Record® range of PRO clamps deliver the right fit, features and pressure for heavy-duty clamping jobs. Professionals will get the clamping performance they need to get the job done right.

# IRWIN® RECORD® PRO CLAMP



#### ENHANCED PERFORMANCE

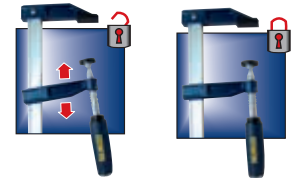

- 1. THERMOPLASTIC ELASTOMERS (TPE) PADS**  
Pads snap fit to prevent loss and provide excellent friction to work surface while reducing marking
- 2. 3-COMPONENT HANDLE**  
For higher torque transfer than wood, plus added comfort (L range has tommy bar)

- 3. ENHANCED PERFORMANCE**  
Updated Rib location improves strength at less weight and allows the clamp to stand horizontally or vertically
- 4. ZINC PLATED I-BEAM**  
Provides higher mechanical strength, less torsion and rust prevention

### PRO CLAMP HOLDING PRESSURES COMPARISON

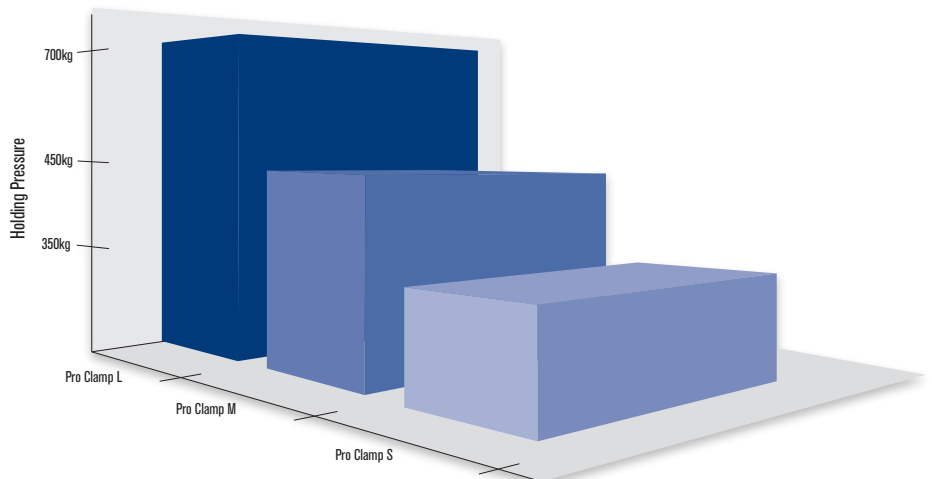

## HEAVY-DUTY PRO CLAMP L WITH TOMMY BAR - CLAMPING DEPTH 140mm

Bar Dimension 35 x 9 mm

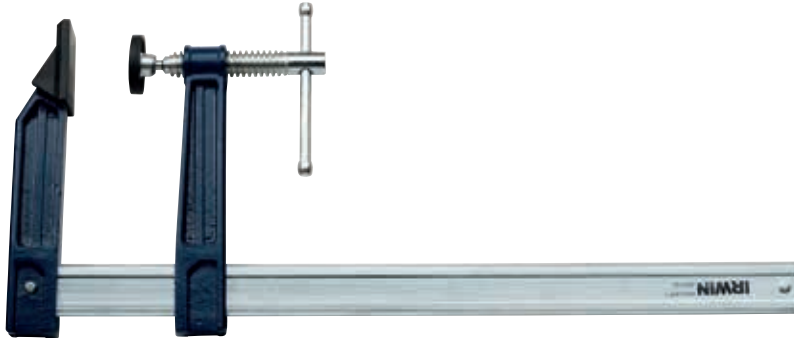

ITEM NO.	DESCRIPTION	CLAMP CAPACITY	EAN	MASTER PACK	SHELF PACK
10503574	Pro Clamp L, 400mm	16" / 400mm	5706915035742	-	3
10503575	Pro Clamp L, 600mm	24" / 600mm	5706915035759	-	3
10503576	Pro Clamp L, 800mm	32" / 800mm	5706915035766	-	3
10503577	Pro Clamp L, 1000mm	40" / 1000mm	5706915035773	-	3
10503578	Pro Clamp L, 1250mm	50" / 1250mm	5706915035780	-	3
10503579	Pro Clamp L, 1500mm	60" / 1500mm	5706915035797	-	3



10503574

## MEDIUM DUTY PRO CLAMP M - CLAMPING DEPTH 120mm

Bar Dimension 30 x 8 mm



ITEM NO.	DESCRIPTION	CLAMP CAPACITY	EAN	MASTER PACK	SHELF PACK
10503569	Pro Clamp M, 300mm	12" / 300mm	5706915035698	-	4
10503570	Pro Clamp M, 400mm	16" / 400mm	5706915035704	-	4
10503571	Pro Clamp M, 600mm	24" / 600mm	5706915035711	-	4
10503572	Pro Clamp M, 800mm	32" / 800mm	5706915035728	-	4
10503573	Pro Clamp M, 1000mm	40" / 1000mm	5706915035735	-	4



10503569

## LIGHT DUTY PRO CLAMP S - CLAMPING DEPTH 80mm

Bar Dimension 25 x 6 mm



ITEM NO.	DESCRIPTION	CLAMP CAPACITY	EAN	MASTER PACK	SHELF PACK
10503564	Pro Clamp S, 200mm	8" / 200mm	5706915035643	-	4
10503565	Pro Clamp S, 300mm	12" / 300mm	5706915035650	-	4
10503566	Pro Clamp S, 400mm	16" / 400mm	5706915035667	-	4
10503567	Pro Clamp S, 600mm	24" / 600mm	5706915035674	-	4
10503568	Pro Clamp S, 800mm	32" / 800mm	5706915035681	-	4



10503565





### T-BAR CLAMPS 136 SERIES AND SPARE PARTS

These clamps resist twisting and distortion under clamping pressures. Both the head and slide are guaranteed unbreakable. The slide is secured by a solid steel pin passing through one of the locating holes spaced along the steel bar. The steel mainscrew applies pressure quickly and smoothly through a fast acting, hard wearing rolled thread. Slides and heads are flat bottomed so that the clamp will stand without support.

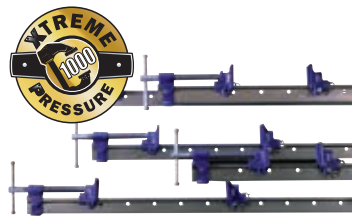

ITEM NO.	DESCRIPTION	CLAMP CAPACITY	EAN	MASTER PACK	SHELF PACK
T1365	T-Bar Clamp	42" / 1070mm	0734442034087	-	1
T1366	T-Bar Clamp	48" / 1200mm	0734442034209	-	1
T1367	T-Bar Clamp	54" / 1350mm	0734442034322	-	1
T1369	T-Bar Clamp	66" / 1680mm	0734442034445	-	1
T13611	T-Bar Clamp	78" / 1980mm	0734442034568	-	1
TL1366	48" Lengthening Bar (1220mm)	-	0734442034681	-	1
T136D	Tailslide with Peg & Chain	-	0734442046561	-	1

### SASH CLAMPS 135 SERIES AND SPARE PARTS

These cut heavy-duty clamps have a bar section of 32mm x 6mm (1-1/4" x 1/4"). The slide and head are guaranteed unbreakable.

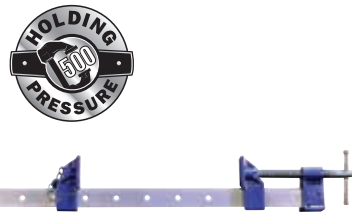

ITEM NO.	DESCRIPTION	CLAMP CAPACITY	EAN	MASTER PACK	SHELF PACK
T1352	Sash Clamp	24" / 610mm	0734442033363	-	1
T1353	Sash Clamp	30" / 760mm	0734442033486	-	1
T1354	Sash Clamp	36" / 915mm	0734442033608	-	1
T1355	Sash Clamp	42" / 1070mm	0734442033721	-	1
T1356	Sash Clamp	48" / 1220mm	0734442033844	-	1
T1357	Sash Clamp	54" / 1370mm	0734442033851	-	1
T1359	Sash Clamp	66" / 1980mm	0734442033875	-	1
TL1354	Sash Clamp, 36" Lengthening Bar (915mm)	-	0734442033967	-	1
T135D	Tailslide with Peg & Chain	-	0734442045366	-	1
T135E	Peg & Chain	-	0734442045960	-	1

### CLAMP HEADS

Low cost alternative to full size bar clamps, the grey cast iron head and slide with steel mainscrew can be fitted to a wooden batten 25mm (1") thick by 38mm (1-1/2") wide and any length.

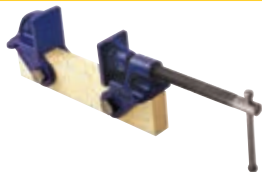

ITEM NO.	DESCRIPTION	EAN	MASTER PACK	SHELF PACK
TM130	Clamp Head, 1" x 1-1/2" / 25 x 38mm	0734442348078	-	6

### MITRE CUTTING CORNER CLAMPS

Accurate mitre clamping is provided by IRWIN® Record® Corner Clamps. The clamps have two countersunk holes for fixing to a wooden block, which can then be secured between the jaws of a bench vice. Thanks to the precision machined clamping surfaces and open design, these clamps are straight forward to operate and provide easy access for gluing and nailing.



ITEM NO.	DESCRIPTION	CLAMP CAPACITY	EAN	MASTER PACK	SHELF PACK
TM140	Mitre Cutting Corner Clamp 50mm	2" / 50mm	0734442028444	24	1
TM141	Mitre Cutting Corner Clamp 100mm	4-1/4" / 105mm	0734442028404	24	1

### FLOORING CLAMP

Designed to close up floor boards prior to nailing, this compact and robust clamp has two spring loaded cams which straddle the joist, holding the clamp firmly in position. Turning the handle then moves the shoe forward, pushing the floorboard into position. For standard 75mm (3") joists.



ITEM NO.	DESCRIPTION	CLAMP CAPACITY	EAN	MASTER PACK	SHELF PACK
TMFC153	Unbreakable S.G. Iron Flooring Clamp 75mm	3" / 75mm	0734442034926	6	1

## G-CLAMPS

IRWIN® Record® G-Clamps have an I-Braced design. They feature an adjustable steel swivel shoe to help clamp uneven surfaces and operation is fast and smooth due to the twin-start Acme cold rolled thread.

# HEAVY-DUTY G-CLAMPS 121 SERIES - THE STRONGEST G-CLAMP

SWIVEL SHOE

TWIN-START ACME COLD ROLLED THREAD

FUSED STEEL HANDLE

DROP-FORGED STEEL FRAME

## HEAVY-DUTY G-CLAMPS 121 SERIES

IRWIN® Record® Heavy-Duty G-Clamps are recommended particularly for metalworking and fabrication work where a very high clamping force is demanded.

- 1. DROP-FORGED STEEL FRAME**  
For strength and durability. Recommended for heavy-duty metal and fabrication work
- 2. SWIVEL SHOE**  
Helps clamping on uneven surfaces
- 3. TWIN-START ACME COLD ROLLED THREAD**  
For faster and smoother operation
- 4. FUSED STEEL HANDLE**  
Will bend before the clamp can be overstressed

ITEM NO.	DESCRIPTION	CLAMP CAPACITY	PROOF LOAD	EAN	MASTER PACK	SHELF PACK
T1213	Heavy-Duty G-Clamp	3" / 75mm	2700 kg	0734442031802	24	4
T1214	Heavy-Duty G-Clamp	4" / 100mm	3200 kg	0734442031925	24	4
T1216	Heavy-Duty G-Clamp	6" / 150mm	4000 kg	0734442032045	12	1
T1218	Heavy-Duty G-Clamp	8" / 200mm	5770 kg	0734442032168	12	1
T12110	Heavy-Duty G-Clamp	10" / 250mm	6200 kg	0734442032281	6	1
T12112	Heavy-Duty G-Clamp	12" / 300mm	6800 kg	0734442032403	6	1
T1224	Deep Throat G-Clamp	4" / 100mm	-	0734442030843	40	4



T1218

## MEDIUM-DUTY G-CLAMPS 119 SERIES

IRWIN® Record® medium-duty clamps have a thin frame for getting into tight corners and confined spaces, yet are very strong and rigid.

ITEM NO.	DESCRIPTION	CLAMP CAPACITY	EAN	MASTER PACK	SHELF PACK
T1192	Medium-Duty G-Clamp	2" / 50mm	0734442030485	-	6
T1193	Medium-Duty G-Clamp	3" / 75mm	0734442030720	-	6
T1194	Medium-Duty G-Clamp	4" / 100mm	0734442000600	-	6
T1196	Medium-Duty G-Clamp	6" / 150mm	0734442041337	-	6



T1193

## GENERAL PURPOSE G-CLAMPS 120 SERIES

Ideal for metal and woodworking applications, the IRWIN® Record® 120 is the most popular and widely used of G-Clamps.

ITEM NO.	DESCRIPTION	CLAMP CAPACITY	EAN	MASTER PACK	SHELF PACK
T1203	General Purpose G-Clamp	3" / 75mm	0734442031086	72	4
T1204	General Purpose G-Clamp	4" / 100mm	0734442031208	72	4
T1206	General Purpose G-Clamp	6" / 150mm	0734442031321	60	4
T1208	General Purpose G-Clamp	8" / 200mm	0734442031444	24	1
T12010	General Purpose G-Clamp	10" / 250mm	0734442031567	24	1
T12012	General Purpose G-Clamp	12" / 300mm	0734442031680	24	1



T1204



**IRWIN®**

*Record®*





## VICES AND ACCESSORIES

IRWIN® Record® Vices have become the benchmark by which all other vices are measured. Design, choice of materials and manufacturing disciplines each set very high standards which, for the end user, translate into safety, reliability and excellent value.

# ENGINEERS' VICE - LIFETIME VICE RANGE

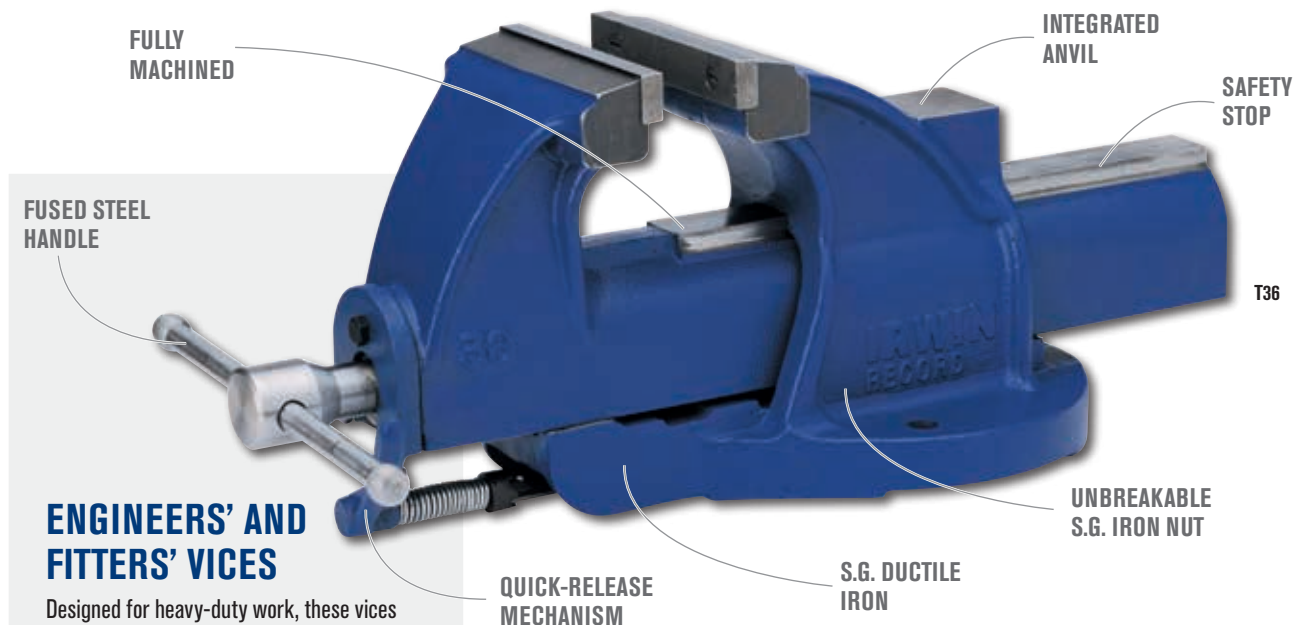

### ENGINEERS' AND FITTERS' VICES

Designed for heavy-duty work, these vices are made from S.G. Ductile Iron with an integrated anvil for shaping and beating, together with a quick-release mechanism for rapid slide adjustment. The reinforced body, slide and large diameter main screw contribute to the working strength and resilience, and the vices withstand the most demanding work. Fitters' vices are similar in design to Engineers' however are made of close grained gray iron instead of S.G. Ductile Iron. They also have a full line of replacement parts available.

1. **S.G. DUCTILE IRON**  
Material with high-impact resistance guarantees strength and long life (Engineers' vices only)
2. **SAFETY STOP**  
Prevents the slide from being separated from the body
3. **FULLY MACHINED**  
On all load-bearing surfaces for smooth and trouble-free operation
4. **FUSED STEEL HANDLE**  
Will bend before the vice can be overstressed
5. **QUICK-RELEASE MECHANISM**  
Disengages the main screw, allowing rapid movement of the slide
6. **UNBREAKABLE S.G. IRON NUT**  
Can be replaced when worn
7. **INTEGRATED ANVIL**  
For efficient striking of workpieces when required

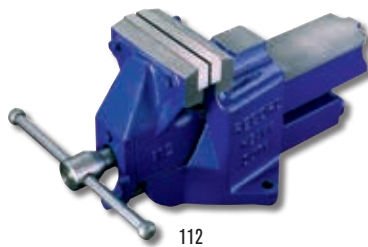
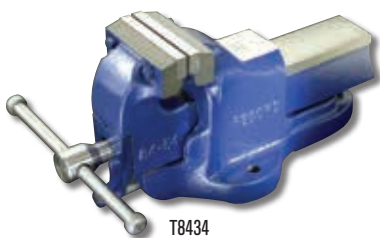

ITEM NO.	DESCRIPTION	EAN	MASTER PACK	SHELF PACK
T8434	Engineers Vice 4-1/2" / 115mm**	0734442019442	42	1
T36	Engineers Vice 6" / 150mm** (Irregular Shape)	0734442019206	18	1
112	Engineers Vice 6" / 150mm**	0734442019565	22	1
114ZR	Engineers Vice 8" / 205mm**	0734442019688	22	1
23ZR	Fitters Vice 4-1/2" / 115mm	0734442001089	28	1
T25	Fitters Vice 6" / 150mm	0734442001201	22	1

**SPARE PARTS ALSO AVAILABLE**  
SEE PAGE 62

\*\*S.G. Ductile Iron is strong and flexible with similar characteristics to steel and is virtually unbreakable. Heavy duty vices manufactured from this material are designed to take much more punishing workloads than normal vices.



# QUICK-ADJUSTING VICE GENERAL PURPOSE / MEDIUM-DUTY



**NEW**

### IRWIN® RECORD® QUICK-ADJUSTING VICE

The NEW Quick-Adjusting Vice features a fast release lever to quickly loosen the jaws of the vice and return it to the locked position, greatly reducing the time necessary to adjust the vice. This vice with integrated anvil is designed for general purpose clamping and medium-duty applications and for applications requiring frequent clamping and changing of multiple materials.



- 1. QUICK-RELEASE FUNCTIONALITY**  
Fast-release lever for quick adjustments to increase productivity
- 2. S.G. DUCTILE IRON BODY**  
Guaranteeing strength and long life
- 3. SWIVEL BASE**  
Three mounting points and a 120° rotation for more flexible positioning of workpieces
- 4. FUSED STEEL HANDLE**  
Will bend before the vice can be overstressed
- 5. INTEGRATED ANVIL**  
For hammering and beating workpieces
- 6. SAFETY STOP**  
Prevents slide separating from body



1978272

ITEM NO.	DESCRIPTION	EAN	MASTER PACK	SHELF PACK
1978271	Quick-Adjusting Vice 4" / 100mm	5706919782710	1	1
1978272	Quick-Adjusting Vice 5" / 125mm	5706919782727	1	1

## MECHANICS' VICE - HEAVY-DUTY RANGE

**IRWIN® RECORD® MECHANICS' VICE**

Rigid and robust, the body and sliding jaw are cast from close grained grey iron which is machined on all friction surfaces for a smooth, reliable action.

The jaws, handle and main screw are steel, the latter having a two-start rolled acme thread to speed the jaws from fully closed to fully open with a minimum of winding. The Mechanics' vice is the most commonly used vice in the IRWIN® Record® range. A full line of replacement parts are available.

- 1. CLOSE GRAINED GREY IRON BODY & SLIDING JAW**  
Cast then machined on all friction surfaces for a smooth, reliable action
- 2. SAFETY STOP**  
Prevents the slide from being separated from the body
- 3. HARDENED STEEL JAWS**  
Extend the life of the jaws and are replaceable
- 4. UNBREAKABLE S.G. IRON NUT**  
Can be replaced when worn
- 5. FUSED STEEL HANDLE**  
Will bend before the vice can be overstressed
- 6. TWIN-START ACME COLD ROLLED THREAD**  
For faster and smoother operation

ITEM NO.	DESCRIPTION	EAN	MASTER PACK	SHELF PACK
1ZR	No 1, Mechanics' Vice 3" / 75mm	0734442000129	144	1
3	No 3, Mechanics' Vice 4" / 100mm	0734442000488	60	1
4ZR	No 4, Mechanics' Vice 4-1/2" / 115mm	0734442000501	40	1
5	No 5, Mechanics' Vice 5" / 125mm	0734442000723	40	1
6	No 6, Mechanics' Vice 6" / 150mm	0734442000846	32	1
8ZR	No 8, Mechanics' Vice 8" / 205mm	0734442000969	24	1



### WORKSHOP VICE - MEDIUM DUTY

Strong and durable, the body and sliding jaw are cast from close-grained grey iron which is machined on all friction surfaces for a smooth reliable action. The jaws, handle and main screw are steel, the latter having a two-start rolled acme thread to speed the jaws from fully closed to fully open with a minimum of winding. This compact bench vice with anvil is specifically designed for medium-duty workshop applications for both the professional craftsman and the DIY enthusiast who expect a compact vice with superior clamping force, safety features and excellent finish.

ITEM NO.	DESCRIPTION	EAN	MASTER PACK	SHELF PACK
10507771	Workshop Vice with Anvil, 3-1/8" / 80mm	5706915077711	1	1
T41211000	Workshop Vice with Anvil, 1 TON, 4" / 100mm	0734442000204	105	1
T3TON3VS	Workshop Vice with Anvil, Swivel Base, 4" / 100mm	0734442000310	60	1
4935505	Workshop Multi-Vice, with Anvil, Swivel Base, 5" / 125mm	0038548989990	40	1
T6TON6VS	Workshop Vice with Anvil, Swivel Base, 6" / 150mm	0734442000860	40	1
8ZR	No 8, Mechanics' Vice 8" / 205mm	0734442000969	24	1

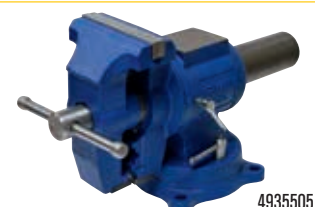



# PROFESSIONAL QUICK-RELEASE WOODWORKING VICE

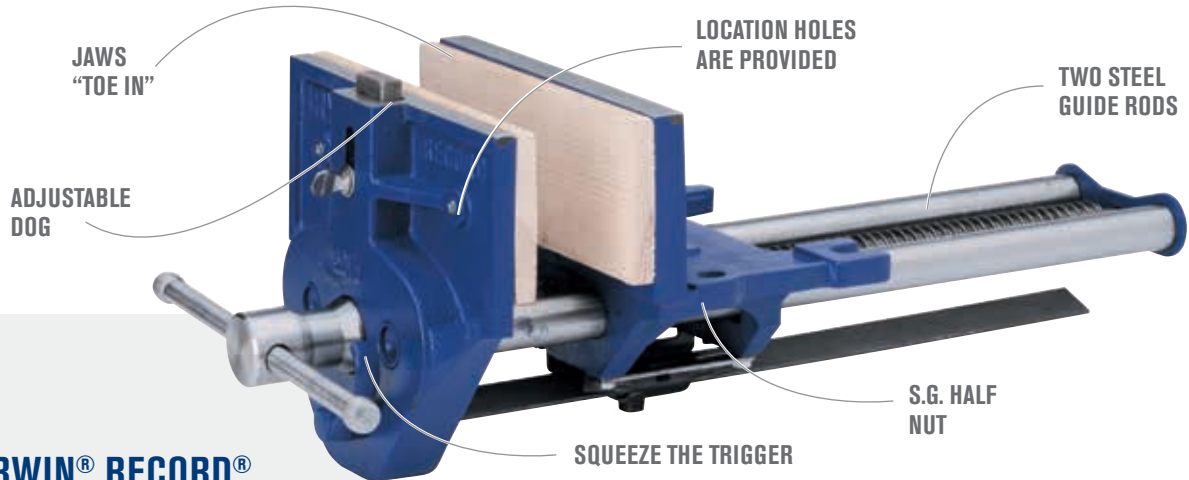

## IRWIN® RECORD® QUICK-RELEASE VICE

Squeeze the trigger and a quick-release vice can be opened and closed without using the mainscrew. Large and small work pieces can be quickly interchanged, while releasing the trigger returns the mechanism to normal for fine adjustment. An ideal addition to the engineering workshop or tool room. For clamping and holding wood work pieces.

- TWO STEEL GUIDE RODS**  
To reduce wear and ensure a smooth parallel action
- JAWS "TOE IN"**  
When pressure is applied they give an even clamping over the whole depth of the work-piece
- ADJUSTABLE DOG**  
Used in conjunction with bench stops fitted into the bench top
- LOCATION HOLES ARE PROVIDED**  
So you can fit your own choice of wooden cheeks to protect the work-piece
- SQUEEZE THE TRIGGER**  
A quick release vice can be opened and closed without using the mainscrew. Large and small work-pieces can be quickly interchanged
- S.G. HALF NUT**  
For longevity and durability replaceable when worn

	ITEM NO.	DESCRIPTION	EAN	MASTER PACK	SHELF PACK
T5212ED	T52ED	Woodworking Vice - Quick-Release 7"/175mm	0734442030249	60	1
	T5212ED	Woodworking Vice - Quick-Release 9"/230mm	0734442030362	32	1
	T53ED	Woodworking Vice - Quick-Release 10-1/2"/265mm	0734442030010	24	1

## PLAIN SCREW VICE

Manufactured in three capacities, these full size workshop vices are designed for bench mounting. The cast grey iron body and front plate are precision machined to house two solid steel guide rods giving the vice a smooth, true parallel action free of side or cross movement.

	ITEM NO.	DESCRIPTION	EAN	MASTER PACK	SHELF PACK
T53PD	T52PD	Woodworking Vice - Plain Screw 7"/175mm	0734442047889	60	1
	T5212PD	Woodworking Vice - Plain Screw 9"/230mm	0734442029796	32	1
	T53PD	Woodworking Vice - Plain Screw 10-1/2"/265mm	0734442030133	24	1

## WOODCRAFT VICE

Lightweight vice for the young woodworker, or home handyman. Provides a robust product suitable for the professional who needs a compact vice for smaller work. Designed to be fitted under the work bench, in the normal way, so that the jaws are flush with the bench top. TV150B includes table clamp.

	ITEM NO.	DESCRIPTION	EAN	MASTER PACK	SHELF PACK
TV150B	TV149B	Woodcraft Vice 6"/150mm	0734442029656	-	1
	TV150B	Woodcraft Vice with Table Clamp 6"/150mm	0734442029779	-	1
	TV175B	Woodcraft Vice 7"/175mm	0734442029885	-	1

## TABLE VICE

This is an ideal portable vice for the amateur and model maker. The built-in clamp allows it to be easily and quickly attached to a bench, table or work surface. Pipe grips are incorporated below the parallel jaws. A useful anvil is also included on the rear of the body.

ITEM NO.	DESCRIPTION	EAN	MASTER PACK	SHELF PACK
TV75B	Table Vice 3" / 75mm	0734442001690	-	1



TV75B

## DRILL PRESS VICE

Quality and precision are the hallmarks of the IRWIN® Record® Drill Press Vice, an ideal addition to the engineering workshop or tool room. Designed for use with drill presses and pillar drills.

ITEM NO.	DESCRIPTION	EAN	MASTER PACK	SHELF PACK
T414	Drill Press Vice 4" / 100mm	0734442001560	-	1



T414

## SWIVEL BASES

360 degree swivel bases are used to rotate and lock the vice at the most convenient angle.

ITEM NO.	DESCRIPTION	EAN	MASTER PACK	SHELF PACK
T1SB	Swivel Base, (No. 1 Vice)	0734442002888	-	1
T3SB	Swivel Base, (No. 3 Vice)	0734442003007	-	1
T4SB	Swivel Base, (No. 4 & 5 Vice)	0734442003120	-	1
T6SB	Swivel Base, (No. 6, 8, 25 & 36 Vices)	0734442003366	-	1
T843423SB	Swivel Base, (No. T8434 & 23ZR Vices)	0734442019459	-	1
10507772	Swivel Base, (No. 10507771)	5706915077728	-	1



T1SB

## FIBRE GRIPS

Designed for holding & protecting workpieces of copper, aluminium, brass and similar soft metals.

ITEM NO.	DESCRIPTION	EAN	MASTER PACK	SHELF PACK
FG3	Fibre Grips 3" / 75mm	0734442001928	60	6
FG4	Fibre Grips 4" / 100mm	0734442002161	60	6
FG412	Fibre Grips 4-1/2" / 115mm	0734442002406	60	6
FG5	Fibre Grips 5" / 125mm	0734442002529	60	6
FG6	Fibre Grips 6" / 150mm	0734442002765	60	6



FG3

FG5

## CHAIN PIPE VICES

The chain pipe vice generates a powerful grip due to its sturdy construction. The drop-forged, heat-treated steel jaws and high-tensile steel chain are mounted on a body cast from ductile iron that is guaranteed unbreakable. The flexible chain means the vice is compact and easy to store when not in use.

ITEM NO.	DESCRIPTION	EAN	MASTER PACK	SHELF PACK
T181C	Chain Pipe Vice 1/8" - 2" / 3 - 50mm	0734442143161	-	1
T182C	Chain Pipe Vice 1/4" - 4" / 6 - 100mm	0734442143284	-	1
T183C	Chain Pipe Vice 1/2" - 8" / 12 - 200mm	0734442143406	-	1



T182C

## HINGED PIPE VICES

The hinged pipe vice frame and base are cast from high-impact resistant S.G. ductile iron guaranteeing strength. The design is ideal for fast, repetitive work.

ITEM NO.	DESCRIPTION	EAN	MASTER PACK	SHELF PACK
T92C	Hinged Pipe Vice 1/8" - 2" / 3 - 50mm	0734442143529	-	1
T9212C	Hinged Pipe Vice 1/8" - 2-1/2" / 3 - 60mm	0734442143642	-	1
T9312C	Hinged Pipe Vice 1/8" - 3-1/2" / 3 - 90mm	0734442143765	-	1
T96	Hinged Pipe Vice 1/8" - 6" / 3 - 150mm	0734442143888	-	1



T9312C

## TRIPOD STAND

The durable fabricated steel frame, topped by a strong heavy-gauge mounting plate, is drilled to accept our range of chain and hinged pipe vices.

ITEM NO.	DESCRIPTION	EAN	MASTER PACK	SHELF PACK
TS10	Tripod Stand for Hinged Pipe Vice & Chain Pipe Vice (T182C, T92C, T9212C)	0734442142560	-	1



### WORKHOLDING - SPARE PARTS

#### T23 - T25 FITTERS' / T36 - T8434 ENGINEERS' / T112 - T114 HD VICES

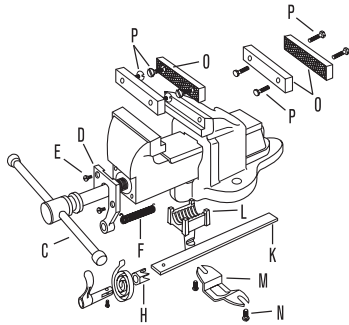

ITEM NO.	DESCRIPTION	EAN	MASTER PACK	SHELF PACK
T23C	Mainscrew with Handle (C), Nut (L), Nut Guide (M), & Screws (N)	0734442010920	-	1
T25C	Mainscrew with Handle (C), Nut (L), Nut Guide (M), & Screws (N)	0734442012603	-	1
T112C	Mainscrew with Handle (C), Nut (L), Nut Guide (M), & Screws (N)	0734442025207	-	1
T114C	Mainscrew with Handle (C), Nut (L), Nut Guide (M), & Screws (N)	0734442025924	-	1
T36C	Mainscrew with Handle (C), Nut (L), Nut Guide (M), & Screws (N)	0734442021841	-	1
84C	Mainscrew with Handle (C), Nut (L), Nut Guide (M), & Screws (N)	0734442023647	-	1
T23DK	Trigger Complete	0734442011408	-	1
T25DK	Trigger Complete	0734442012962	-	1
T112DK	Trigger Complete	0734442025801	-	1
T114DK	Trigger Complete	0734442026402	-	1
T36DK	Trigger Complete	0734442022329	-	1
T84DK	Trigger Complete	0734442024002	-	1
T23L	Half Nut (L), Guide (M) & Screws (N)	0734442011163	-	1
T25L	Half Nut (L), Guide (M) & Screws (N)	0734442012849	-	1
T112L	Half Nut (L), Guide (M) & Screws (N)	0734442025443	-	1
T114L	Half Nut (L), Guide (M) & Screws (N)	0734442026167	-	1
T36L	Half Nut (L), Guide (M) & Screws (N)	0734442022084	-	1
T84L	Half Nut (L), Guide (M) & Screws (N)	0734442022688	-	1
T230	Jaw Plates (pair) with Screws (P)	0734442011286	-	1
T250	Jaw Plates (pair) with Screws (P)	0734442011521	-	1
T1120	Jaw Plates (pair) with Screws (P)	0734442025566	-	1
T1140	Jaw Plates (pair) with Screws (P)	0734442026280	-	1
T360	Jaw Plates (pair) with Screws (P)	0734442022206	-	1
T840	Jaw Plates (pair) with Screws (P)	0734442023883	-	1

#### SPARE PARTS FOR NO.1 - NO. 8 MECHANICS' VICES

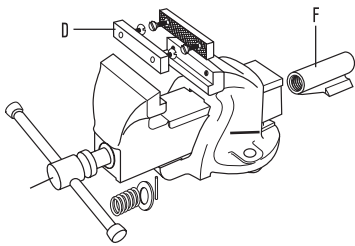

ITEM NO.	DESCRIPTION	EAN	MASTER PACK	SHELF PACK
T1C	Mainscrew with Handle, Nut, Pin, Spring Washer & Pin (C) & (F)	0734442004561	-	1
T3C	Mainscrew with Handle, Nut, Pin, Spring Washer & Pin (C) & (F)	0734442006121	-	1
T4C	Mainscrew with Handle, Nut, Pin, Spring Washer & Pin (C) & (F)	0734442006961	-	1
T5C	Mainscrew with Handle, Nut, Pin, Spring Washer & Pin (C) & (F)	0734442007807	-	1
T6C	Mainscrew with Handle, Nut, Pin, Spring Washer & Pin (C) & (F)	0734442008521	-	1
T8C	Mainscrew with Handle, Nut, Pin, Spring Washer & Pin (C) & (F)	0734442009009	-	1
T1D	Pair of Jaw Plates with Screws	0734442004684	-	1
T3D	Pair of Jaw Plates with Screws	0734442006244	-	1
T4D	Pair of Jaw Plates with Screws	0734442007081	-	1
T5D	Pair of Jaw Plates with Screws	0734442007920	-	1
T6D	Pair of Jaw Plates with Screws	0734442008644	-	1
T8D	Pair of Jaw Plates with Screws	0734442009481	-	1

#### SPARE PARTS FOR T400300 PIPE VICE

ITEM NO.	DESCRIPTION	EAN	MASTER PACK	SHELF PACK
T661053	50mm Hinged Pipe Vice for Stand Benders	0686182000788	-	1



## SPARE PARTS FOR T52 - T53 QUICK-RELEASE VICES

ITEM NO.	DESCRIPTION	EAN	MASTER PACK	SHELF PACK
T52EDA	Sliding Jaw (A)	0734442037323	-	1
T5212EDA	Sliding Jaw (A)	0734442038528	-	1
T53EDA	Sliding Jaw (A)	0734442009955	-	1
T52EDC	Main Screw with Handle & Washers (E), Pin (F), Nut (O)	0734442037569	-	1
T5212EDC	Main Screw with Handle & Washers (E), Pin (F), Nut (O)	0734442038764	-	1
T53EDC	Main Screw with Handle & Washers (E), Pin (F), Nut (O)	0734442009962	-	1
T52EDD	End Bracket with End Washers & Pin (F)	0734442037682	-	1
T5212EDD	End Bracket with End Washers & Pin (F), also fits T53ED	0734442038887	-	1
T52EDJN	Trigger Complete	0734442038405	-	1
T5212EDJN	Trigger Complete (also fits T53ED)	0734442039488	-	1
T52EDL	Trigger Spring & Nut (fits all sizes)	0734442038047	-	1
T52EDO	Nut with Nut Guide & Screws	0734442038160	-	1
T5212EDO	Nut with Nut Guide & Screws (also fits T53ED)	0734442039242	-	1
T52EDT	Front Dog with Screws & Washers (fits all sizes)	0734442040927	-	1

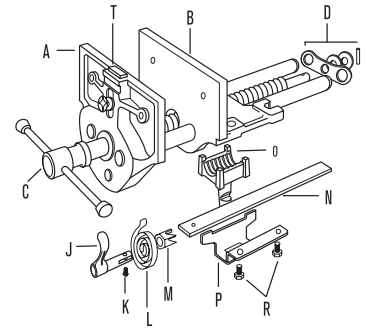

## SPARE PARTS FOR T52 - T53 PLAIN SCREW VICES

ITEM NO.	DESCRIPTION	EAN	MASTER PACK	SHELF PACK
T52PDC	Mainscrew with Handle & Pin (F) & Nut (O)	0734442047902	-	1
T5212PDC	Mainscrew with Handle & Pin (F) & Nut (O)	0734442009924	-	1
T53PDC	Mainscrew with Handle & Pin (F) & Nut (O)	0734442009979	-	1
T5212PDO	Nut (also fits T53PD)	0734442009931	-	1

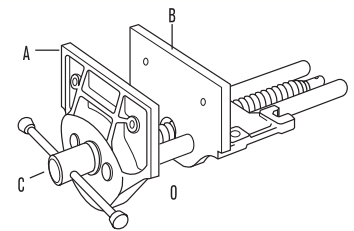

## SPARE PARTS FOR T92C - T93-1/2C & T96 HINGED PIPE VICES

ITEM NO.	DESCRIPTION	EAN	MASTER PACK	SHELF PACK
T92CC	Main Screw with Handle	0734442160564	-	1
T9212CC	Main Screw with Handle	0734442163442	-	1
T92CD	Locking Hook & Rivet (H)	0734442160687	-	1
T9212CD	Locking Hook & Rivet (H)	0734442163565	-	1
T92CE	Jaw Clamp (Per Pair)	0734442160809	-	1
T9312CE	Jaw Clamp (Per Pair)	0734442166320	-	1
T92CF	Lower Jaws (Pair) with Bolts & Nuts	0734442160922	-	1
T9312CF	Lower Jaws (Pair) with Bolts & Nuts	0734442165484	-	1
T96F	Lower Jaws (Pair) with Bolts & Nuts	0734442168720	-	1
T92CG	Upper Jaws with Bolts & Nuts	0734442162247	-	1
T9312CG	Upper Jaws with Bolts & Nuts	0734442165606	-	1
T96G	Upper Jaws with Bolts & Nuts	0734442168843	-	1

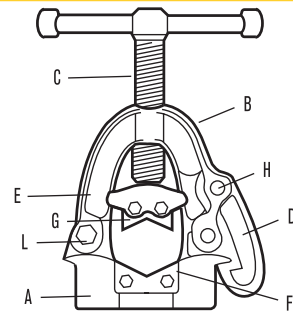

## SPARE PARTS FOR T181C, T182C, T183C CHAIN PATTERN VICES

ITEM NO.	DESCRIPTION	EAN	MASTER PACK	SHELF PACK
T183CA	Base	0734442157328	-	1
T182CB	Jaw Unit with Bolt	0734442156963	-	1
T183CB	Jaw Unit with Bolt	0734442157441	-	1
T182CC	Chain with Screw	0734442157083	-	1
T183CC	Chain with Screw	0734442159124	-	1
T183CD	Handle with Nut	0734442157564	-	1

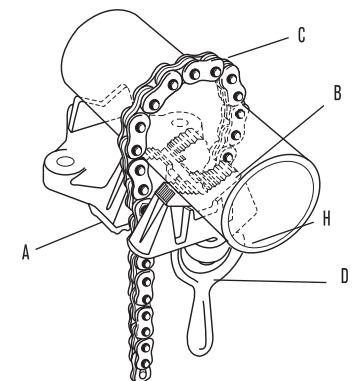

**IRWIN**<sup>®</sup>





# SCREWDRIVERS & HEX KEYS

## PRO COMFORT & VDE INSULATED SCREWDRIVERS

The new IRWIN® Pro Comfort Screwdrivers have been designed for comfort, durability and safety. The screwdrivers feature a dual material, trilobular handle for an ergonomic grip, black phosphate magnetic tip and are made with Chrome-vanadium (Cr-V) steel shafts with corrosion protection. The VDE range of screwdrivers are insulated for electrical work up to 1000V AC.

## PRO COMFORT SCREWDRIVERS

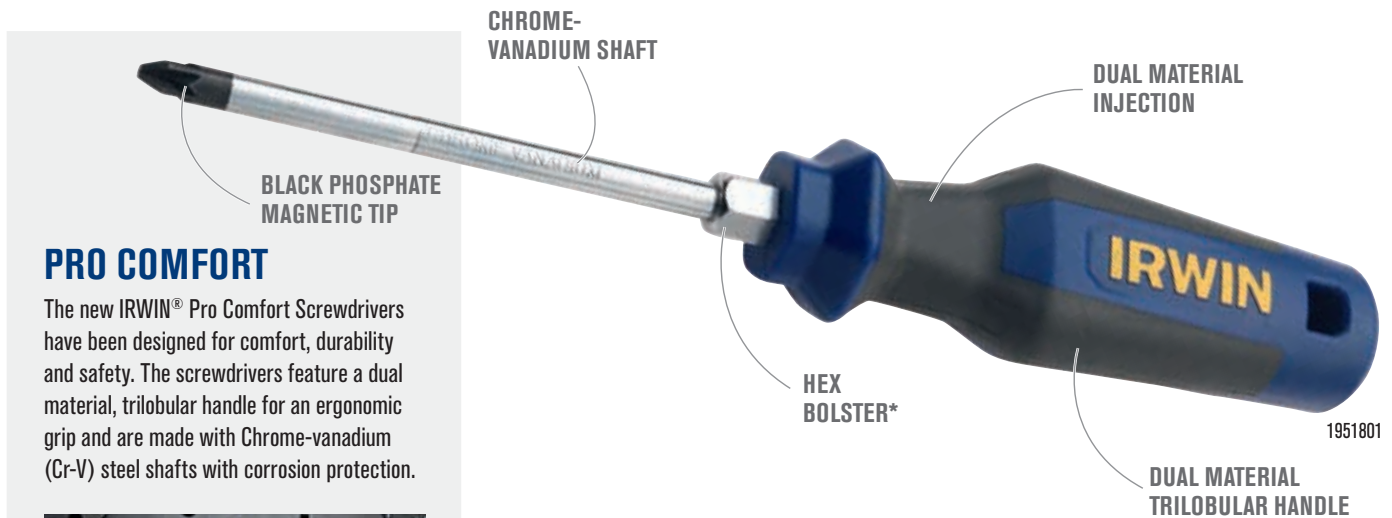

### PRO COMFORT

The new IRWIN® Pro Comfort Screwdrivers have been designed for comfort, durability and safety. The screwdrivers feature a dual material, trilobular handle for an ergonomic grip and are made with Chrome-vanadium (Cr-V) steel shafts with corrosion protection.



- 1. DUAL MATERIAL TRILOBULAR HANDLE**  
Provides an ergonomic grip
- 2. BLACK PHOSPHATE MAGNETIC TIP**  
For improved screw alignment, easy driving and extended life of tip
- 3. DUAL MATERIAL INJECTION**  
Delivers greater comfort in use
- 4. CHROME-VANADIUM SHAFT**  
Includes corrosion protection for longer life of the tool
- 5. HEX BOLSTER\***  
Allows for increased torque with use of wrench

\* Select skus only

### POZIDRIV

ITEM NO.	DESCRIPTION	EAN	MASTER PACK	SHELF PACK
1951676	Pro Comfort Screwdriver PZ #0 x 80mm	5706919516766	120	6
1951677	Pro Comfort Screwdriver PZ #1 x 30mm	5706919516773	120	6
1951678	Pro Comfort Screwdriver PZ #1 x 100mm	5706919516780	72	6
1951679	Pro Comfort Screwdriver PZ #1 x 250mm	5706919516797	72	6
1951680	Pro Comfort Screwdriver PZ #2 x 30mm	5706919516803	120	6
1951801	Pro Comfort Screwdriver PZ #2 x 100mm with Hex Bolster	5706919518012	72	6
1951802	Pro Comfort Screwdriver PZ #2 x 125mm with Hex Bolster	5706919518029	72	6
1951803	Pro Comfort Screwdriver PZ #2 x 250mm with Hex Bolster	5706919518036	48	6



### PHILLIPS

ITEM NO.	DESCRIPTION	EAN	MASTER PACK	SHELF PACK
1951814	Pro Comfort Screwdriver PH #0 x 80mm	5706919518142	120	6
1951807	Pro Comfort Screwdriver PH #1 x 100mm	5706919518074	72	6
1951808	Pro Comfort Screwdriver PH #1 x 250mm	5706919518081	72	6
1951810	Pro Comfort Screwdriver PH #2 x 38mm	5706919518104	120	6
1951811	Pro Comfort Screwdriver PH #2 x 100mm with Hex Bolster	5706919518111	72	6
1951812	Pro Comfort Screwdriver PH #2 x 125mm with Hex Bolster	5706919518128	72	6
1951813	Pro Comfort Screwdriver PH #2 x 250mm with Hex Bolster	5706919518135	48	6
1951816	Pro Comfort Screwdriver PH #3 x 150mm with Hex Bolster	5706919518166	48	6

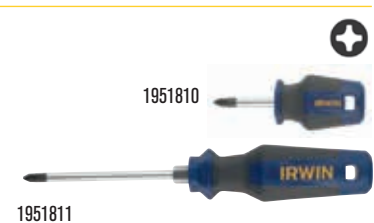



## SLOTTED



1951821

ITEM NO.	DESCRIPTION	EAN	MASTER PACK	SHELF PACK
1951818	Pro Comfort Screwdriver SL 3 mm x 80mm	5706919518180	120	6
1951819	Pro Comfort Screwdriver SL 3mm x 100mm	5706919518197	120	6
1951820	Pro Comfort Screwdriver SL 5mm x 100mm	5706919518203	72	6
1951821	Pro Comfort Screwdriver SL 5.5mm x 100mm	5706919518210	72	6
1951824	Pro Comfort Screwdriver SL 6.5mm x 150mm with Hex Bolster	5706919518241	72	6
1951825	Pro Comfort Screwdriver SL 8mm x 150mm with Hex Bolster	5706919518258	48	6
1951826	Pro Comfort Screwdriver SL 8mm x 175mm with Hex Bolster	5706919518265	48	6
1951827	Pro Comfort Screwdriver SL 8mm x 200mm with Hex Bolster	5706919518272	48	6
1951828	Pro Comfort Screwdriver SL 9mm x 200mm with Hex Bolster	5706919518289	48	6

## PARALLEL



1951848

ITEM NO.	DESCRIPTION	EAN	MASTER PACK	SHELF PACK
1951842	Pro Comfort Screwdriver PARA 3mm x 100mm	5706919518425	120	6
1951843	Pro Comfort Screwdriver PARA 3 mm x 150mm	5706919518432	120	6
1951844	Pro Comfort Screwdriver PARA 3.5mm x 80mm	5706919518449	120	6
1951845	Pro Comfort Screwdriver PARA 4mm x 100mm	5706919518456	120	6
1951846	Pro Comfort Screwdriver PARA 4mm x 150mm	5706919518463	120	6
1951848	Pro Comfort Screwdriver PARA 5.5mm x 100mm	5706919518487	72	6
1951849	Pro Comfort Screwdriver PARA 5.5mm x 150mm	5706919518494	72	6
1951850	Pro Comfort Screwdriver PARA 6.5mm x 30mm	5706919518500	120	6

## TORX



1951857

ITEM NO.	DESCRIPTION	EAN	MASTER PACK	SHELF PACK
1951855	Pro Comfort Screwdrivers T10 x 100mm	5706919518555	72	6
1951856	Pro Comfort Screwdrivers T15 x 100mm	5706919518562	72	6
1951857	Pro Comfort Screwdrivers T20 x 100mm	5706919518579	72	6
1951858	Pro Comfort Screwdrivers T25 x 125mm	5706919518586	72	6
1951859	Pro Comfort Screwdrivers T27 x 125mm	5706919518593	72	6
1951860	Pro Comfort Screwdrivers T30 x 125mm	5706919518609	72	6
1951861	Pro Comfort Screwdrivers T40 x 150mm	5706919518616	48	6

## VDE INSULATED SCREWDRIVERS

**VDE INSULATION**

**BLACK PHOSPHATE MAGNETIC TIP**

**CHROME-VANADIUM SHAFT**

**DUAL MATERIAL INJECTION**

**DUAL MATERIAL TRILOBULAR HANDLE**

1951864

**VDE INSULATED**

- VDE INSULATION**  
Insulated for electrical work up to 1000V AC
- DUAL MATERIAL TRILOBULAR HANDLE**  
Provides an ergonomic grip
- BLACK PHOSPHATE MAGNETIC TIP**  
For improved screw alignment, easy driving and extended life of tip
- DUAL MATERIAL INJECTION**  
Delivers greater comfort in use
- CHROME-VANADIUM SHAFT**  
Includes corrosion protection for longer life of the tool

### POZIDRIV

ITEM NO.	DESCRIPTION	EAN	MASTER PACK	SHELF PACK
1951867	Pro Comfort VDE Insulated Screwdriver PZ #0 x 80 mm	5706919518678	120	6
1951866	Pro Comfort VDE Insulated Screwdriver PZ #1 x 100mm	5706919518661	120	6
1951865	Pro Comfort VDE Insulated Screwdriver PZ #2 x 125mm	5706919518654	72	6



### PHILLIPS

ITEM NO.	DESCRIPTION	EAN	MASTER PACK	SHELF PACK
1951862	Pro Comfort VDE Insulated Screwdriver PH #0 x 80 mm	5706919518623	120	6
1951863	Pro Comfort VDE Insulated Screwdriver PH #1 x 100mm	5706919518630	120	6
1951864	Pro Comfort VDE Insulated Screwdriver PH #2 x 125mm	5706919518647	72	6



### PARALLEL

ITEM NO.	DESCRIPTION	EAN	MASTER PACK	SHELF PACK
1951868	Pro Comfort VDE Insulated Screwdriver PARA 3.5 mm x 80mm	5706919518685	120	6
1951869	Pro Comfort VDE Insulated Screwdriver PARA 4mm x 100mm	5706919518692	120	6
1951870	Pro Comfort VDE Insulated Screwdriver PARA 2.5mm x 50mm	5706919518708	120	6
1951881	Pro Comfort VDE Insulated Screwdriver PARA 5.5mm x 150mm	5706919518814	72	6



## SCREWDRIVER SETS



1951882



1951883



1951884

ITEM NO.	DESCRIPTION	EAN	MASTER PACK	SHELF PACK
1951882	<b>10pc Pro Comfort Screwdrivers Set:</b> PZ #0 x 80mm, PZ #1 x 100mm, PZ #2 x 30mm, PARA 3mm x 100mm, PH #1 x 100, PH #2 x 125mm, SL 5.5mm x 100mm, SL 6.5mm x 150mm, SL 8mm x 150mm	5706919518821	20	5
1951883	<b>9pc Pro Comfort Screwdrivers Set:</b> PZ #0 x 80mm, PZ #1 x 100mm, PZ #2 x 125mm, PARA 4mm x 100mm, PARA 5.5mm x 150mm, PARA 6.5mm x 30mm, SL 3mm x 80mm, SL 5mm x 100mm, SL 5.5mm x 100mm	5706919518838	20	5
1951884	<b>6pc Pro Comfort VDE Insulated Screwdrivers Set:</b> PARA 2mm x 50mm, PARA 3.5mm x 80mm, PARA 4mm x 100mm, PZ #0 x 80mm, PZ #1 x 100mm, PZ #2 x 125mm	5706919518845	30	5

## SPECIALITY SCREWDRIVER SETS



1951885

**SPINNING HEADS ON HANDLES** for controlled torque in precision work  
**CHROME-VANADIUM (CR-V) SHAFT** includes corrosion protection for longer life of the tool  
**STORAGE CASE INCLUDED** for convenient storage

ITEM NO.	DESCRIPTION	EAN	MASTER PACK	SHELF PACK
1951885	<b>5pc Precision Screwdriver Set:</b> SL 2mm x 50mm x 136mm, SL 2.5mm x 50mm x 136mm, SL 3mm x 50mm x 136mm, PH #00 x 50mm x 136mm, PH #0 x 50mm x 136mm	5706919518852	48	6

## SCREWDRIVER ACCESSORIES

The 2-in-1 functionality featured on this accessory allows users to magnetise or demagnetise screwdrivers in seconds.



1953963

ITEM NO.	DESCRIPTION	EAN	MASTER PACK	SHELF PACK
1953963	MAGNETISER / DEMAGNETISER	5706919539635	48	6



# SCREWDRIVERS & HEX KEYS

## HEX KEYS

**ERGONOMIC PROTOUCH™ GRIP DESIGN**

**SLOT MACHINED TIP**

**OXIDED**

**HEAT-TREATED CHROME-VANADIUM STEEL**

**T HANDLE HEX KEYS**

Manufactured from high-strength and durable chrome vanadium steel. Ergonomic design to ease gripping and handling, improving the torque performance. Routed tip finish for better gripping and holding of screws. Special surface treatment to prevent oxidation and corrosion.

**1. HEAT-TREATED CHROME-VANADIUM STEEL**  
Cr-V with high-resistant heat treatment is high-strength and durable for long tool life

**2. SLOT MACHINED TIP**  
Routed tip finish for better gripping and holding of screws

**3. ERGONOMIC PROTOUCH™ GRIP DESIGN**  
For comfort and better gripping to improve torque performance

**4. OXIDED**  
Special surface treatment to prevent oxidation and corrosion

**ProTouch GRIPS**

### 'T' HANDLE HEX KEY SETS

ITEM NO.	DESCRIPTION	EAN	MASTER PACK	SHELF PACK
T10771	8pc Set MM: 2.0, 2.5, 3.0, 4.0, 5.0, 6.0, 8.0, 10.0 mm	7897095029299	3	3



T10771

### HOLSTER HEX KEYS SET

Durable ABS holster sets available in varying diameters, offer practicality in any use and organize tools compactly.

ITEM NO.	DESCRIPTION	EAN	MASTER PACK	SHELF PACK
T10755	Short Hex Key - MM: 1.5, 2.0, 2.5, 3.0, 4.0, 5.0, 6.0, 7.0, 8.0, 10.0mm	7897095029138	-	6
T10756	Long Hex Key - MM: 1.5, 2.0, 2.5, 3.0, 4.0, 5.0, 6.0, 7.0, 8.0, 10.0mm	7897095029145	-	6
T10757	Ball-Ended Hex Key - MM: 1.5, 2.0, 2.5, 3.0, 4.0, 5.0, 6.0, 7.0, 8.0, 10.0 mm	7897095029152	-	6
T10758	Torx Key: T6, T7, T8, T10, T15, T20, T25, T27, T30, T40	7897095029169	-	6



T10756

### HEX AND TORX KEYS - FOLD UP SETS

Retractable set of IRWIN® Hex and Torx keys housed in a high-resistance, polyamide and fiberglass handle. Ergonomic rubber grip for greater comfort and ease of use.

ITEM NO.	DESCRIPTION	EAN	MASTER PACK	SHELF PACK
T10765	Hex Key - MM: 2.0, 2.5, 3.0, 4.0, 5.0, 6.0, 8.0 mm	7897095029237	-	6
T10767	Torx Key: T9, T10, T15, T20, T25, T27, T30, T40	7897095029251	-	6
T10769	Ball - Ended Hex Key - MM: 2.0, 2.5, 3.0, 4.0, 5.0, 6.0, 8.0 mm	7897095029275	-	6
T10768	Ball - Ended Hex Key - IMPERIAL: 9pc. 5/64" - 1/4"	7897095029268	-	6



T10765

### STANDARD HEX KEY SETS

The most popular hex key sizes in one set come with permanent size markings for quick identification.

ITEM NO.	DESCRIPTION	EAN	MASTER PACK	SHELF PACK
T10745	Short Hex Key - IMPERIAL: 9pc. 1/16" - 3/8"	7897095029039	-	5
T10747	Ball-Ended Hex Key - IMPERIAL: 9pc. 1/16" - 3/8"	7897095029053	-	5

**IRWIN®**



# UTILITY KNIVES & BLADES

## BI-METAL UTILITY BLADES



SHATTERPROOF

TRAPEZOID BLADES  
FIT MOST KNIVES

LAST 3 TIMES  
LONGER\*



### BI-METAL BLUE BLADES

Bi-Metal is formed by welding high-speed steel edge and spring steel, having the benefit of both types: **Safety & Longer Life.**

IRWIN® Bi-metal Blue Blades are safer since they will not break under normal working conditions, and they help reduce the risk of injury from breaking or shattering blades. And, with the blades lasting longer than traditional carbon blades, they result in fewer blade changes which means fewer accidental cuts.

SNAP-OFF BLADES  
SOFT SNAP  
TECHNOLOGY

#### 1. SHATTERPROOF

Spring steel allows the blade to bend without accidentally breaking

#### 2. LAST 3 TIMES LONGER\*

High speed steel hardened cutting edge stays sharp 3X longer than traditional carbon blades which means more cuts for the money

#### 3. TRAPEZOID BLADES FIT MOST KNIVES

Two-notch blade design fits most utility knives

#### 4. SNAP-OFF BLADES SOFT SNAP TECHNOLOGY

For breaking a new edge confidently

**3X LONGER LIFE\***  
\*vs. traditional carbon blades



\*vs IRWIN® carbon blades 10504245 / 10504561

### BI-METAL BLUE TRAPEZOID BLADES

ITEM NO.	DESCRIPTION	EAN	MASTER PACK	SHELF PACK
10504240	Bi-Metal Blue Trapezoid blades - 5pk	5706915042405	25	5
10504241	Bi-Metal Blue Trapezoid blades - 10pk	5706915042412	25	5
10504243	Bi-Metal Blue Trapezoid blades - 100pk, Dispenser	5706915042436	5	1



### BI-METAL BLUE SAFETY BLADES

All the benefits of the Bi-Metal Trapezoid Blade but with a snub nose design which helps to reduce the risk of accidental puncture wounds.

ITEM NO.	DESCRIPTION	EAN	MASTER PACK	SHELF PACK
10505823	Bi-Metal 'Blue' Safety Trap Blade 5pk	5706915058239	25	5
10505824	Bi-Metal 'Blue' Safety Trap Blade 50pk, Dispenser	5706915058246	5	1



Bi-Metal Safety Blade - Not Pointed

### SNAP-OFF BI-METAL BLUE BLADES

ITEM NO.	DESCRIPTION	EAN	MASTER PACK	SHELF PACK
10507102	Bi-Metal 'Blue' Snap-Off Blade 18mm 5pk	5706915071023	-	10
10507103	Bi-Metal 'Blue' Snap-Off Blade 18mm 8pk	5706915071030	-	10
10507104	Bi-Metal 'Blue' Snap-Off Blade 18mm 50pk	5706915071047	-	2
10507105	Bi-Metal 'Blue' Snap-Off Blade 18mm 10 x 8pk	5706915071054	50	10





## CARBON STEEL UTILITY BLADES

# CARBON STEEL 4-POINT TRAPEZOID BLADES

This IRWIN® innovation combines the toughness of a traditional trapezoid blade with the increased blade tip life of a snap-off blade. Scored edges give the user 4 sharp points (vs. 2 points on a standard trapezoid blade) which doubles the life of the blade. The 4 notches enable the blade to be extended to maintain blade length after snapping off sections of the blade.

**2X** LONGER LIFE\*  
\*vs. traditional carbon blades



ITEM NO.	DESCRIPTION	EAN	MASTER PACK	SHELF PACK
10508107	4Point Carbon Steel Blade - 5pk	5706915081077	25	5
10508108	4Point Carbon Steel Blade - 10pk	5706915081084	25	5
10508110	4Point Carbon Steel Blade - 100pk, Dispenser	5706915081107	5	1

## CARBON STEEL BLADES

Carbon blade with carbon steel cutting edge for general purpose cutting.



ITEM NO.	DESCRIPTION	EAN	MASTER PACK	SHELF PACK
10504245	Carbon Steel Blades - 5pk	5706915042450	-	5
10504246	Carbon Steel Blades - 10pk	5706915042467	-	5
10504247	Carbon Steel Blades - 100pk, Dispenser	5706915042474	-	1

## CARBON STEEL HOOKED BLADES

Carbon blade with hooked point to protect surfaces underneath the blade.



ITEM NO.	DESCRIPTION	EAN	MASTER PACK	SHELF PACK
10504249	Carbon Steel Hooked Blades - 5pk	5706915042498	-	5
10504250	Carbon Steel Hooked Blades - 10pk	5706915042504	-	5
10504251	Carbon Steel Hooked Blades - 100pk, Dispenser	5706915042511	-	1

## SNAP-OFF CARBON STEEL BLADES

Carbon blade snaps cleanly at the intended point and provides user with a regular sharp new cutting tip.



ITEM NO.	DESCRIPTION	EAN	MASTER PACK	SHELF PACK
10504558	Carbon Steel Snap-Off Blade 25mm 5pk	5706915045581	-	5
10504559	Carbon Steel Snap-Off Blade 25mm 10pk	5706915045598	-	5
10504561	Carbon Steel Snap-Off Blade 18mm 5pk	5706915045611	-	5
10504562	Carbon Steel Snap-Off Blade 18mm 10pk	5706915045628	-	5
10504563	Carbon Steel Snap-Off Blade 18mm 50pk	5706915045635	-	1
10504567	Carbon Steel Snap-Off Blade 9mm 10pk	5706915045673	-	5
10506456	Carbon Steel Snap-Off Blade Bulk 18mm 100pk	5706915064568	-	1

# UTILITY KNIVES & BLADES

## FK SERIES FOLDING UTILITY KNIVES

The IRWIN® Folding Utility Knives range features a new collection of best-in-class knives developed from intensive research on the needs of professional users. This innovative range meets the high standards required by today's professional users – where safety, durability, convenience and comfort are the most important factors.

**PATENTED BLADELOK TECHNOLOGY**

**LINER LOCK**

**16° CUTTING ANGLE AND CAST FINGER GROOVES**

**BUILT-IN BLADE STORAGE**

**FK250 FOLD-OUT SCREWDRIVER & BIT STORAGE**

**ALL METAL BODY**

**WIRE STRIPPER & BELT CLIP**

1888439

**FK SERIES FOLDING KNIFE**

**Included:**

- PH2
- S1

Fold-out Screwdriver and additional bit storage

**BladeLock TECHNOLOGY**  
KEEPS BLADE LOCKED IN

**BiMetal**  
BLADES LAYERS • HOLES

- PATENTED BLADELOK TECHNOLOGY**  
Keeps blade locked in place
- LINER LOCK**  
For safe, one-handed operation
- 16° CUTTING ANGLE AND CAST FINGER GROOVES**  
For ultimate comfort and control
- WIRE STRIPPER & BELT CLIP**  
For built-in convenience
- BUILT-IN BLADE STORAGE**  
Holds up to two additional blades (not available on FK100)
- ALL METAL BODY**  
Design provides added durability (excluding FK150)
- FK250 FOLD-OUT SCREWDRIVER & BIT STORAGE**  
Fits 1" insert bits for quick fixes and provides additional tool versatility (PH2 and SQ2 included)

ITEM NO.	DESCRIPTION	EAN	MASTER PACK	SHELF PACK
1888437	FK100 Folding Knife with 1 Bi-metal Blade	5706918884378	-	5
1888438	FK150 Folding Knife with 3 Bi-Metal Blades	5706918884385	-	5
1888439	FK250 Folding Knife with 3 Bi-Metal Blades	5706918884392	-	5



### FOLDING KNIFE

This high-quality and compact knife design features a 45° quick-change mechanism to increase both productivity and safety. In addition, the knife features an anchored belt clip, extended thumb ledge, and wire stripper. The knife comes with a Bi-Metal utility blade.

ITEM NO.	DESCRIPTION	EAN	MASTER PACK	SHELF PACK
10507695	Folding Knife	5706915076950	30	10



## RETRACTABLE UTILITY KNIVES

IRWIN® offers an extensive range of retractable utility knives designed to be used in a variety of applications and to meet the needs of discerning trade professionals.

# PROTOUCH™ X RETRACTABLE UTILITY KNIFE

QUICK-CHANGE  
BLADE MECHANISM

3-STEP RETRACTION

INCLUDES 3 BI-METAL BLADES  
WITH 3X LONGER LIFE

HINGED BLADE  
STORAGE

## PROTOUCH™ X RETRACTABLE UTILITY KNIFE

Ideal for many professional trades to be used in multiple applications, in particular roofing.



TRIGGER GRIP

HARD-WEARING ALUMINIUM  
WITH PROTOUCH™ SOFT GRIP

### 1. QUICK-CHANGE BLADE MECHANISM

Easy blade change with safe lock system to prevent blade from slipping during use

### 2. HINGED BLADE STORAGE

Tool free access to storage for up to 10 blades

### 3. TRIGGER GRIP

For cutting on the pull

### 4. HARD-WEARING ALUMINIUM WITH PROTOUCH™ SOFT GRIP

Knife is robust, but lightweight with an ergonomic grip for added comfort and to reduce hand fatigue

### 5. 3-STEP RETRACTION

For multiple cutting depths

### 6. INCLUDES 3 BI-METAL BLADES WITH 3X LONGER LIFE

vs. traditional carbon blades

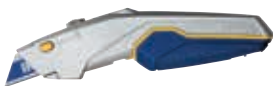

ITEM NO.	DESCRIPTION	EAN	MASTER PACK	SHELF PACK
10508104	ProTouch™ X Retractable Knife	5706915081046	25	5

## XP RETRACTABLE KNIFE

This knife, with a single piece steel nose and robust body sets the standard for durability. The quick-change mechanism, easy tool-free entry and 5-blade storage save users time.



ITEM NO.	DESCRIPTION	EAN	MASTER PACK	SHELF PACK
10507404	XP Retractable Knife	5706915074048	40	8

## PROTOUCH™ RETRACTABLE KNIFE

This knife has an optimised cutting angle to minimise fatigue and includes magnetic blade retention and storage for up to 5 blades.



ITEM NO.	DESCRIPTION	EAN	MASTER PACK	SHELF PACK
10504236	ProTouch™ Retractable Knife	5706915042368	-	5

## GENERAL CONSTRUCTION RETRACTABLE KNIFE

A lightweight and durable retractable knife to get all jobs done. The push and slide opening mechanism provides easy tool-free blade access for quick blade changes, and the knife parts are secured to prevent dropping/losing components.



ITEM NO.	DESCRIPTION	EAN	MASTER PACK	SHELF PACK
10508105	General Contractor Retractable Knife	5706915081053	-	5



# UTILITY KNIVES & BLADES

## PROFESSIONAL RETRACTABLE KNIFE

This general purpose knife has a lightweight, but hard-wearing aluminium body to hold up on the job. A magnet holds the working blade in place and a captive screw prevents loss during blade change.

ITEM NO.	DESCRIPTION	EAN	MASTER PACK	SHELF PACK
10504238	Professional Retractable Knife	5706915042382	-	5



## RETRACTABLE KNIFE

This professional entry-level retractable knife is highly durable, lightweight, and features an optimised cutting angle for minimal fatigue.

ITEM NO.	DESCRIPTION	EAN	MASTER PACK	SHELF PACK
10504238	Professional Retractable Knife	5706915042382	-	5



## FIXED UTILITY KNIVES

### PROTOUCH FIXED KNIFE

A feature-rich fixed knife that is designed with an optimised cutting angle to minimise fatigue and a ProTouch™ for a secure grip and greater comfort in use.

ITEM NO.	DESCRIPTION	EAN	MASTER PACK	SHELF PACK
10504237	ProTouch Fixed Knife	5706915042375	-	5



**TOOL-FREE ENTRY** for easy blade changes  
**BUILT-IN BLADE STORAGE** holds up to 5 blades  
**MAGNETIC BLADE HOLDER** prevents blade from falling out when casing is open  
**PROTOUCH™ GRIP** for comfort and control

### DRYWALLER FIXED KNIFE

This professional fixed knife is the ideal tool to be used in drywall cutting applications. It is specially made for working in dusty conditions that normally ruin tools. It is robust and lightweight and the slim nose for scoring makes this product unique.

ITEM NO.	DESCRIPTION	EAN	MASTER PACK	SHELF PACK
10508103	Drywaller Fixed Knife	5706915081039	-	5



### PROFESSIONAL FIXED KNIFE

This knife features a strong die cast aluminium body with 19° angled nose for greater comfort and to reduce strain.

ITEM NO.	DESCRIPTION	EAN	MASTER PACK	SHELF PACK
10504239	Professional Fixed Knife	5706915042399	-	5



### FIXED KNIFE

This professional entry-level fixed knife is highly durable, lightweight and features an optimised cutting angle for minimal fatigue.

ITEM NO.	DESCRIPTION	EAN	MASTER PACK	SHELF PACK
10507449	Fixed Knife	5706915074499	25	5



## SPECIALITY KNIVES

### SELF-RETRACTING KNIFE

This TUV certified safety knife is designed to minimise the risk of injury.

ITEM NO.	DESCRIPTION	EAN	MASTER PACK	SHELF PACK
10505822	Self Retractable Knife	5706915058222	-	5



**SPRING RETURN SHUTTLE** ensures blade automatically retracts at the end of a cutting action  
**STRONG DIECAST ALUMINIUM BODY WITH 19° ANGLED NOSE** for more comfortable cutting and to reduce strain  
**MULTI-FUNCTIONAL DESIGN** allows for two blade settings that include normal use and as a box cutter  
**MAGNETISED BLADE HOLDER** prevents blade from falling out  
**CAPTIVE BALE SCREW** for easy tool-free blade changes  
**BUILT-IN BLADE STORAGE** holds up to three blades  
**INCLUDES 1 SHATTERPROOF BI-METAL SAFETY BLADE WITH 3X LONGER LIFE\***

\*vs. IRWIN® carbon blades #10504245

## PROTOUCH™ SNAP-OFF HEAVY DUTY KNIFE

**SLIM NOSE DESIGN**

**SOLID CAST ALUMINIUM BODY AND STEEL BLADE GUIDE**

**SELF-LOCKING BLADE SLIDE**

**BLADE STORAGE**

**PROTOUCH™ GRIP**

**IMPACT RESISTANT HINGED END-CAP**

**PROTOUCH™ SNAP-OFF HEAVY DUTY KNIFE**

A feature-rich, heavy-duty knife with manual screw tightening at the nose for user controlled blade security. Other features include cartridge for storing 2 blades, durable cast aluminium body with stainless steel blade guide, hinged end-cap, and ProTouch™ grip for a secure grip and greater comfort.

- 1. SELF-LOCKING BLADE SLIDE**  
For fast blade adjustment on medium-duty tasks
- 2. BLADE STORAGE**  
For three blades inside the removable cartridge
- 3. SOLID CAST ALUMINIUM BODY AND STEEL BLADE GUIDE**  
For durability
- 4. PROTOUCH™ GRIP**  
Provides excellent control
- 5. SLIM NOSE DESIGN**  
For maximum visibility of the cutting surface
- 6. IMPACT-RESISTANT HINGED END-CAP**  
Cannot be separated from knife body

ITEM NO.	DESCRIPTION	EAN	MASTER PACK	SHELF PACK
10507106	ProTouch™ Snap-Off Heavy-Duty Knife, 18mm	5706915071061	-	8

### PROTOUCH™ SNAP-OFF KNIFE

This ProTouch™ knife is designed for a variety of light- to medium-duty applications. The handle provides a secure grip and greater comfort in use and the slim nose design provides accuracy with improved visibility to cutting surfaces.

ITEM NO.	DESCRIPTION	EAN	MASTER PACK	SHELF PACK
10504553	ProTouch™ Snap-Off Knife, 25mm	5706915045536	-	5
10504555	ProTouch™ Snap-Off Knife 9mm	5706915045550	-	5

### PROFESSIONAL SNAP-OFF SCREW KNIFE

This durable snap-off knife features a screw thread for convenient user-controlled blade fixture. Blade storage for two blades inside the removable cartridge. Strong ABS body with steel blade guide. Texture grip provides improved control. Slim nose design for maximum visibility of the cutting surface. Hinged end cap cannot be separated from body.

ITEM NO.	DESCRIPTION	EAN	MASTER PACK	SHELF PACK
10507580	Professional Screw Knife Bi-Metal Blade - 18mm	5706915075809	-	5

# UTILITY KNIVES & BLADES

## SNAP-OFF SCREW KNIFE

A professional knife featuring a screw fixture for convenient user controlled blade fixture and a strong ABS Body. The textured grip provides improved control.

ITEM NO.	DESCRIPTION	EAN	MASTER PACK	SHELF PACK
10508135	Snap-Off Screw Knife - 18mm	5706915081350	-	5
10508136	Snap-Off Screw Knife - 25mm	5706915081367	-	5



## CARPET LAYER SNAP-OFF KNIFE

This knife features a built-in metal carpet tucker for increased versatility. The solid cast aluminium body with steel blade guide provides more durability, and the lightweight and durable handle minimises fatigue. Plus, the screw thread provides convenient user controlled blade fixture.

ITEM NO.	DESCRIPTION	EAN	MASTER PACK	SHELF PACK
10507843	Carpet Layer Snap-Off Knife 18mm	5706915078435	25	5



## SNAP-OFF KNIFE

A popular knife format featuring self-locking blade adjustment together with a removable end-cap which can assist breakage of each blade segment.

ITEM NO.	DESCRIPTION	EAN	MASTER PACK	SHELF PACK
10506543	Snap-Off Knife 9mm	5706915065435	-	5
10506546	Snap-Off Knife Bulk 9mm 24pk	5706915065466	120	24
10506544	Snap-Off Knife 18mm	5706915065442	-	5
10506547	Snap-Off Knife Bulk 18mm 24pk	5706915065473	120	24
10507446	Snap-Off Knife Bulk with 18mm Bi-Metal Blade 100pk	5706915074468	-	100





# IRWIN®

## STRAIT-LINE®



## TAPE MEASURES

### PROFESSIONAL TAPE MEASURE RANGE

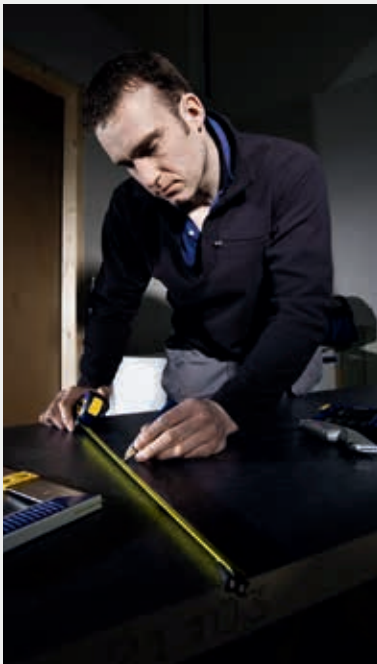

**ProTouch™ GRIPS**

1. **BLADE STAND-OUT**  
3m (10ft): 1,4m (4-2/3ft) / 5m (16ft): 1,8m (6ft) / 8m (26ft): 2,3m (7-1/2ft)
2. **NYLON COATING**  
For 2X longer life vs. standard IRWIN® tapes
3. **3-RIVET END HOOK**  
With reinforced metal backing for durability
4. **MAGNETIC END HOOK**  
For working with metal structures
5. **FAST LOCK**  
For quick and easy blade control
6. **DOUBLE-SIDED PRINTING**  
For greater visibility and convenience
7. **PROTOUCH™ GRIP**  
For comfort in use

ITEM NO.	DESCRIPTION	BLADE WIDTH	EAN	MASTER PACK	SHELF PACK
<b>METRIC</b>					
10507790	Professional 3m Tape Measure	16mm	5706915077902	60	6
10507791	Professional 5m Tape Measure	19mm	5706915077919	60	6
10507792	Professional 8m Tape Measure	25mm	5706915077926	48	6
10508059	Professional 5m Tape Measure, 12pcs Bulk	19mm	5706915080599	-	12
10508060	Professional 8m Tape Measure, 12pcs Bulk	25mm	5706915080605	-	12
<b>METRIC / IMPERIAL</b>					
10507793	Professional 3m/10ft Tape Measure	16mm	5706915077933	60	6
10507794	Professional 5m/16ft Tape Measure	19mm	5706915077940	60	6
10507795	Professional 8m/26ft Tape Measure	25mm	5706915077957	48	6
10508062	Professional 5m/16ft Tape Measure, 12pcs Bulk	19mm	5706915080629	-	12



10507791



## STANDARD TAPE MEASURE RANGE



10507788

**BLADE STAND-OUT** 3m (10ft): 1,2m (4ft) / 5m (16ft): 1,8m (6ft) / 8m (26ft): 2,3m (7-1/2ft)

**ACRYLIC COATING** for rust and abrasion protection

**THREE RIVET END HOOK** with reinforced metal backing for durability

**SLIDING LOCK** for easy blade control

**ABS PLASTIC CASE WITH PROTOUCH™ GRIP** for comfort and durability

ITEM NO.	DESCRIPTION	BLADE WIDTH	EAN	MASTER PACK	SHELF PACK
<b>METRIC</b>					
10507784	Standard 3m Tape Measure	13mm	5706915077841	60	6
10507785	Standard 5m Tape Measure	19mm	5706915077858	60	6
10507786	Standard 8m Tape Measure	25mm	5706915077865	48	6
10508052	Standard 3m Tape Measure, 12pcs Bulk	13mm	5706915080520	-	12
10508053	Standard 5m Tape Measure, 12pcs Bulk	19mm	5706915080537	-	12
10508054	Standard 8m Tape Measure, 12pcs Bulk	25mm	5706915080544	-	12
<b>METRIC / IMPERIAL</b>					
10507787	Standard 3m/10ft Tape Measure	13mm	5706915077872	60	6
10507788	Standard 5m/16ft Tape Measure	19mm	5706915077889	60	6
10507789	Standard 8m/26ft Tape Measure	25mm	5706915077896	48	6



## CHALK REELS

IRWIN® STRAIT-LINE® has manufactured chalk reels designed with the end-user in mind for more than 50 years. The new chalk reel range features larger chalk fill openings designed for ease and speed and delivers best-in-class line strength and reel durability to hold up to jobsite wear and tear.

# MACH6™ CHALK REEL

**NEW**



## MACH6™ CHALK REEL



**6X FASTER\***

\*as compared to traditional chalk reels

- 1. EASY FILL & LOCK TOP**  
Large, 90°-turn locking top for quick chalk fill and easy access to reel internals
- 2. 6:1 GEAR RATIO**  
Rewinds the line 6X faster than traditional chalk reels
- 3. 2.5X STRONGER HI-TENSILE LINE**  
For fewer breaks and for use on rough, abrasive surfaces
- 4. OPEN ACCESS BACK PANEL**  
Allows for quick line change and cleaning
- 5. METAL DRIVE GEAR**  
Resists gear failure under heavy load
- 6. ROBUST STEEL HANDLE & LARGE ERGONOMIC CLUTCH**  
For increased durability and torque plus easy line release
- 7. WIDE-PRONG HOOK**  
For secure anchoring
- 8. DURABLE ALUMINIUM HOUSING**  
Provides impact resistance

ITEM NO.	DESCRIPTION	EAN	MASTER PACK	SHELF PACK
10507681	Strait-Line MACH6™ Chalk Reel 30m/100'	5706915076813	-	6
10507684	MACH6™ Reel 30m/100' + Blue Chalk 113g	5706915076844	-	8



10507684

## STRAIT-LINE®

### SPEEDLINE PRO™ CHALK REEL



10507794

**NEW**



**2.5X**  
STRONGER LINE\*

**3X** FASTER\*

**EASY FILL & LOCK TOP** for quick chalk fill and easy access to reel internals  
**2.5X STRONGER HI-TENSILE LINE** for fewer breaks  
**3:1 GEAR RATIO** rewinds line 3X faster than traditional chalk reels  
**ROBUST STEEL HANDLE & LARGE ERGONOMIC CLUTCH** for increased durability, strength and torque  
**WIDE PRONG HOOK** for secure anchoring  
**LIGHTWEIGHT ABS HOUSING** withstands jobsite wear and tear

ITEM NO.	DESCRIPTION	EAN	MASTER PACK	SHELF PACK
10507676	SPEEDLINE PRO Chalk Reel 30m/100'	5706915076769	144	6
10507677	SPEEDLINE PRO Chalk Reel 30m/100', 24 pcs, Bulk	5706915076776	-	24
10507682	SPEEDLINE PRO Reel 30m/100' + Blue Chalk 113g	5706915076820	72	3

\*vs traditional chalk reels

### CLASSIC CHALK REEL



10507678

**70% WIDER DOOR** for quick and easy chalk fill  
**ABRASION RESISTANT LINE** provides 5-6 strikes per pull  
**1:1 GEAR RATIO** rewinds line  
**HEAVY-DUTY ALUMINIUM, ROBUST STEEL HANDLE, LARGE CENTER HUB** for increased durability

ITEM NO.	DESCRIPTION	EAN	MASTER PACK	SHELF PACK
10507678	Classic Aluminium Chalk Reel 15m/50'	5706915076783	144	6
10507679	Classic Aluminium Chalk Reel 30m/100'	5706915076790	144	6
10507680	Classic Aluminium Chalk Reel 30m/100', 24 pcs, Bulk	5706915076806	-	24
10507683	Classic Aluminium Reel 30m/100' + Blue Chalk 113g	5706915076837	72	3

## MARKING CHALK

IRWIN® STRAIT-LINE® marking chalks have an innovative flip-top cap that keeps the chalk in the bottle where you want it. The flip-top cap seals the chalk in an airtight chamber, keeping out moisture and reducing the risk of clumping.

### Marking Chalk Colour Permanence & Application Guide

Blue Chalk - Standard indoor/outdoor (1 week) Red Chalk - Outdoor permanent (up to 2 months).

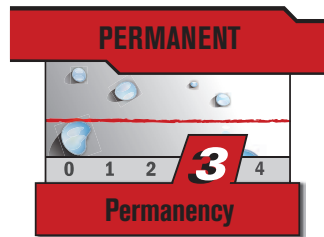
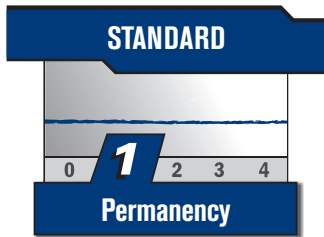

65201

64901

64902

ITEM NO.	DESCRIPTION	EAN	MASTER PACK	SHELF PACK
64801ZR	Blue Marking Chalk 4oz/113g	0024721500014	24	6
64802	Red Marking Chalk 4oz/113g	0024721500052	24	6
64901	Blue Marking Chalk 8oz/227g	0024721500076	24	6
64902	Red Marking Chalk 8oz/227g	0024721500120	24	6
65201	Blue Marking Chalk 2.5lbs/1.1kg	0024721652010	6	1

## REPLACEMENT LINES

ITEM NO.	DESCRIPTION	EAN	MASTER PACK	SHELF PACK
1932892	15m/50' Polyester Replacement Line	00042526936913	144	6
1932893	30m/100' Polyester Replacement Line	00042526936920	144	6
1932894	30m/100' Hi-Tensile Replacement Line	00042526936937	144	6



1932894

## STRAIT-LINE CRAYONS



66401ZR

ITEM NO.	DESCRIPTION	EAN	MASTER PACK	SHELF PACK
66401ZR	Red Crayon, Bulk 12pk	0024721664013	-	1
66404	Black Crayon, Bulk 12pk	0024721664044	-	1
66406	Yellow Crayon, Bulk 12pk	0024721664068	-	1
666012	Red Crayon, Carded 2 pk	0024721061904	-	12
666042	Black Crayon, Carded 2 pk	0024721061935	-	12
666062	Yellow Crayon, Carded 2 pk	0024721061959	-	12

**FOR USE ON OILY, slick, wet, cold or dry surfaces**  
**IDEAL FOR CONCRETE, ceramics, rubber, metal, paper and cardboard**  
**NON-TOXIC and waterproof**

## STRAIT-LINE CARPENTER PENCILS & SHARPENER



66300

ITEM NO.	DESCRIPTION	EAN	MASTER PACK	SHELF PACK
233250	Carpenter Pencil Sharpener	0024721007087	-	25
66300	Medium Pencil, Bulk 12pcs	0024721663009	144	12
66305SL	Medium Pencil, Box 72pcs	0024721028150	1440	72



233250



**IRWIN**<sup>®</sup>





## TOOL STORAGE

Professional end-users have high demands for their tools. IRWIN® understands these demands. Toughness and value are qualities you'll find in every IRWIN® toolbag and organiser.

### SOFT-SIDE TOOL ORGANISER

Long enough to carry saws and levels with space and pockets for other tools. Size: 600 x 260 x 400mm.

ITEM NO.	DESCRIPTION	EAN	MASTER PACK	SHELF PACK
10505369	Soft-Sided Tool Organiser, Zipper	5706915053692	5	1



### BIGFOOT TOOL BAG

Versatile large capacity bag with a waterproof base, keeps plans and documents dry, even on wet or muddy ground. Size: 222 x 406 x 305mm.

ITEM NO.	DESCRIPTION	EAN	MASTER PACK	SHELF PACK
10506529	Bigfoot Tool Bag	5706915065299	4	4



### DOUBLE WIDE TOOL BAG

Two large compartments for hand tools, power tools and smaller compartments for screws and nails. As strong as a tool box but lightweight and easier to carry. Size: 140 x 508 x 324mm.

ITEM NO.	DESCRIPTION	EAN	MASTER PACK	SHELF PACK
10506531	Double Wide Tool Bag	5706915065312	4	4



### TOOL TOTE

Designed like the traditional metal tool tote but lightweight and easier to carry. Wide top opening for easy access and loops to carry blueprints or a level. Size: 210 x 419 x 260mm.

ITEM NO.	DESCRIPTION	EAN	MASTER PACK	SHELF PACK
10506532	Tool Tote	5706915065329	4	4



### PROFESSIONAL SOFT-SIDE TOOL ORGANISER

Small, lightweight and strong with zip fastening for security. Padded handle features reinforced stitching for extra strength. Extra wide opening provides easy access to all tools. Size: 440 x 285 x 190mm.

ITEM NO.	DESCRIPTION	EAN	MASTER PACK	SHELF PACK
10503820	PRO Soft Side Tool Organiser	5706915038200	4	4



### PROFESSIONAL LARGE TOOL ORGANISER

Large capacity storage with top opening for quick and easy access. False bottom provides separate storage for important items. Durable plastic bottom is water resistant. Reinforced handle features extra strength rivets. Size: 420 x 350 x 245mm.

ITEM NO.	DESCRIPTION	EAN	MASTER PACK	SHELF PACK
10503818	PRO Large Tool Organiser	5706915038187	4	4





## PROFESSIONAL UTILITY TOOL ORGANISER

Enough capacity to carry range of tools and accessories. Pockets and compartments designed to provide better organisation. Bottom made of tough wear resistant plastic. Reinforced rivets throughout for added durability. Size: 320 x 250 x 350mm.

ITEM NO.	DESCRIPTION	EAN	MASTER PACK	SHELF PACK
10503819	PRO Utility Tool Organiser	5706915038194	4	4



## BUILDERS NAIL & TOOL POUCH

Consists of vertical tool or fastener storage that attaches directly to a belt. Designed to be worn for left or right hand access. Size: 290 x 305mm.

ITEM NO.	DESCRIPTION	EAN	MASTER PACK	SHELF PACK
10506534	Builders Nail & Tool Pouch	5706915065343	25	5



## ELECTRICIAN'S UTILITY POUCH

Electrician's utility pouch, designed for left- or right-handed use. Back wall slots for long handled tools. Front pockets for smaller tools. Size: 190 x 290mm.

ITEM NO.	DESCRIPTION	EAN	MASTER PACK	SHELF PACK
10506535	Electrician's Utility Pouch	5706915065350	25	5



## PROFESSIONAL STRUCTURAL FOAM TOOLBOX

A heavy-duty structural foam, unlike most plastic or metal tool boxes, this box will stand years of use and abuse. Size: 760 x 365 x 320mm

ITEM NO.	DESCRIPTION	EAN	MASTER PACK	SHELF PACK
10503817	PRO Structural Foam Toolbox	5706915038170	4	4



## PROFESSIONAL KNEEPADS

### I-GEL™ KNEEPADS

These comfortable and safe kneepads are made of perforated Neoprene material with impact resistant I-Gel inserts. The double straps do not restrict blood flow and the pads are notched for comfort when standing.

ITEM NO.	DESCRIPTION	EAN	MASTER PACK	SHELF PACK
10503830	I-Gel™ Kneepads	5706915038309	6	6

### ALL-TERRAIN KNEEPADS

Wide-body keeps stance more stable on uneven surfaces. Foam cushion under pad protects knee from rough surfaces.

ITEM NO.	DESCRIPTION	EAN	MASTER PACK	SHELF PACK
10503831	All-Terrain Kneepads	5706915038316	6	6

### SWIVEL-FLEX KNEEPADS

Convex cap design provides better pivoting and less resistance, giving greater manoeuvrability across textured surfaces.

ITEM NO.	DESCRIPTION	EAN	MASTER PACK	SHELF PACK
10503832	Swivel-Flex Kneepads	5706915038323	6	6



## PROFESSIONAL WORK GLOVES

### GENERAL CONSTRUCTION GLOVES

The construction gloves feature two layers of synthetic suede on the palm, thumb and fingers for comfort and extended wear. The rubberised finger tips provide better gripping and the knuckles are padded with perforated Neoprene for breathability and protection. The gloves are form-fitted for improved fit and dexterity.

ITEM NO.	DESCRIPTION	EAN	MASTER PACK	SHELF PACK
10503822	General Construction Gloves, L	5706915038224	24	6
10503823	General Construction Gloves, XL	5706915038231	24	6

### EXTREME CONDITIONS GLOVES

These gloves, designed for extreme conditions, are made from a fleece lined stretch material for added warmth and better fit with a non-slip reinforced palm, thumb and fingertips and form-fitting, breathable stretch materials added for comfort. Also, they include a convenient terry cloth insert for brow wipes.

ITEM NO.	DESCRIPTION	EAN	MASTER PACK	SHELF PACK
10503824	Extreme Conditions Gloves, L	5706915038248	24	6
10503825	Extreme Conditions Gloves, XL	5706915038255	24	6

### HEAVY-DUTY JOBSITE GLOVES

These gloves are designed for harsh applications and rough materials, without losing dexterity. The grip-reinforced palm, thumb and fingertips provide extra durability. Knuckles are padded with perforated Neoprene for breathability and protection.

ITEM NO.	DESCRIPTION	EAN	MASTER PACK	SHELF PACK
10503826	Heavy-Duty Jobsite Gloves, L	5706915038262	24	6
10503827	Heavy-Duty Jobsite Gloves, XL	5706915038279	24	6

### CARPENTER GLOVES

The carpenter gloves have an open finger design to allow for better dexterity. Their reinforced palm, thumb and fingertips provide extra durability and protection. Knuckles are padded with perforated Neoprene for breathability and protection.

ITEM NO.	DESCRIPTION	EAN	MASTER PACK	SHELF PACK
10503828	Carpenter Gloves, L	5706915038286	24	6
10503829	Carpenter Gloves, XL	5706915038293	24	6



**IRWIN**<sup>®</sup>

**hilmor**<sup>®</sup>





## PIPE AND TUBE BENDERS

With the IRWIN® Hilmor® range of tube benders, you can be ready to tackle any job with ease. All machines feature precision tooling to give a smooth, accurate bend every time across a large range of sizes.

# GLM HAND BENDING MACHINE

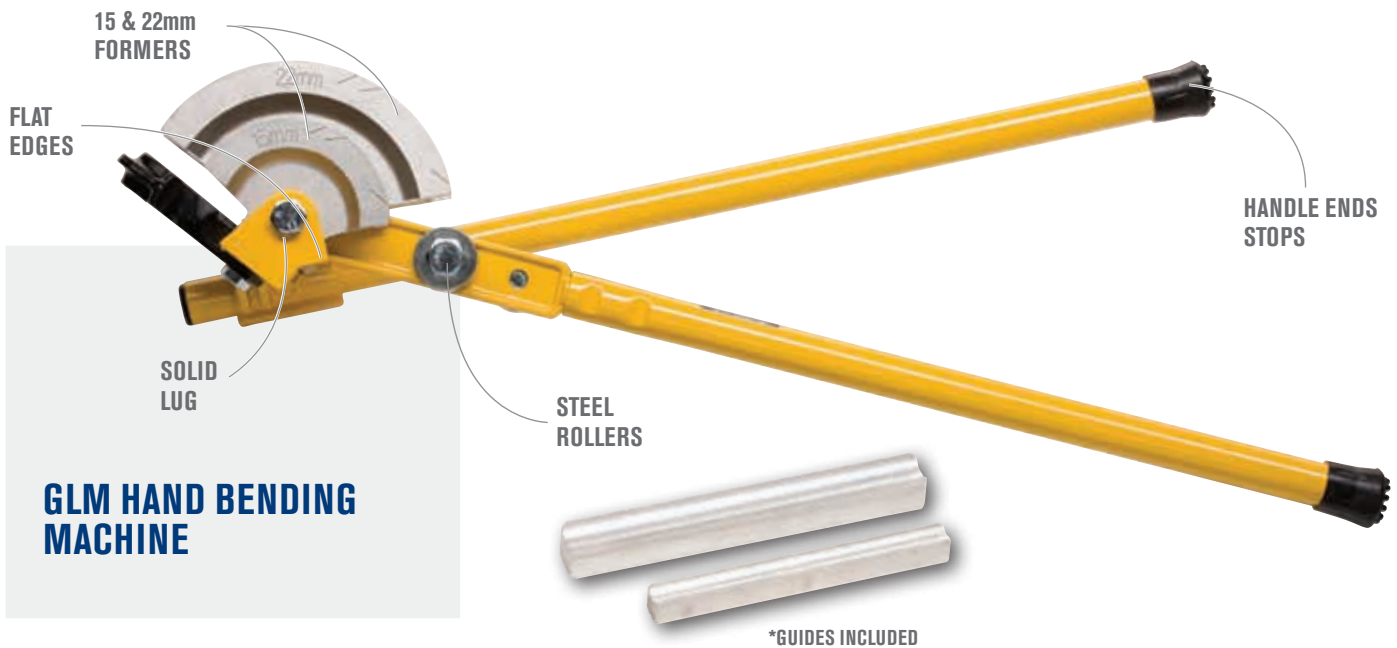

- 1. FORMERS SUPPORTED ON BOTH SIDES**  
Prevents twisting under heavy loading
- 2. DURABLE, HARD-WEARING STEEL ROLLERS**  
Last much longer than aluminium
- 3. SOLID LUG**  
Allows the pipe bender to be held firmly between vice jaws
- 4. HEAVY-GAUGE FORMERS (15mm & 22mm)**  
Won't lose their shape and include degree marks on the casting for 'at-a-glance' accuracy
- 5. FLAT EDGES TO THE BRACKET ARM**  
Allow the GLM to be used in workshop vice for convenient bending
- 6. HANDLE END STOPS WITH STEEL INSERTS**  
Protect user hands during bending, eliminate piercing and increase durability

ITEM NO.	DESCRIPTION	EAN	MASTER PACK	SHELF PACK
T591057	GLM Hand Bending Machine 15/22mm	0686182000016	-	1
T660032	Hook stop and bolt for GLM	0686182001006	-	1



## MULTI-MINI HAND BENDER

The IRWIN® Hilmor® Multi-Mini bender is a small lightweight bender that is able to bend 6, 8 & 10mm copper tube in one convenient machine. The Multi-Mini is able to produce bends of 180°

ITEM NO.	DESCRIPTION	EAN	MASTER PACK	SHELF PACK
T676810	Multi-Mini Tube Bender 6, 8, 10mm (Root Radii 22.5, 20 & 15mm)	0686182000061	-	8





### ROLLER PIPE CUTTERS

Designed to cut steel pipe, this tool has one fast cutting wheel and two wide rollers. As well as keeping the cutter squarely on track, the rollers smooth down the surface leaving a clean-cut ready for jointing or threading.

ITEM NO.	DESCRIPTION	EAN	MASTER PACK	SHELF PACK
T202	Roller Pipe Cutter, 1/8"-2" (10-60mm)	0734442115564	-	1
T202DF	Roller with Pin T202	0734442137641	-	1
T202EF	Wheel with Pin T202	0734442131526	-	1



### TUBE CUTTERS AND SPARE WHEELS

Exceptionally thin, fast cutting wheel and two rollers to ensure the cutting wheel is held squarely on the tube resulting in a square cut. Fitted with wide rollers to hold the tube square against the cutting wheel to prevent "tramlining."

ITEM NO.	DESCRIPTION	EAN	MASTER PACK	SHELF PACK
T20030C	Tube Cutter, 3-30mm	0734442118084	-	6
T20045	Tube Cutter, 15-45mm	0734442118183	-	4
T20030CD	Wheel for Tube Cutter T20030C	0734442117964	-	1
T20045D	Wheel for Tube Cutter T20045	0734442132004	-	1



### PLASTIC PIPE CUTTERS

The T850026 pipe cutter features a "V" shaped blade which allows for off-centre motion reducing tube deformation. The specially hardened steel blade also gives greater cutting pressure with less effort making it easier to use. IRWIN's PVC cutter has a simple one-handed ratcheting operation that provides smooth cutting and clean pipe ends. Plus, the rubberised grips provide confident, safe handling.

ITEM NO.	DESCRIPTION	EAN	MASTER PACK	SHELF PACK
T850026	26mm Plastic Pipe Cutter	0686182000221	-	10
10507485	45mm PVC Tube Cutter	5706915074857	-	4



### TUBE BENDERS

This tube bender is made from strong precision die-castings with integral formers and guides. This makes it lightweight, easy to use and accurate. Each of the benders is suitable for bending three sizes of copper, brass, aluminium or steel tubing.

ITEM NO.	DESCRIPTION	EAN	MASTER PACK	SHELF PACK
T210	Mini Tube Bender 3, 4, 6mm Copper	0734442144052	48	4



# hilmor®

## MANUAL BENDING MACHINES

### EL RANGE CONDUIT BENDING MACHINES AND SPARE PARTS

The IRWIN® Hilmor® EL range is easily portable and the EL25 is the lightest conduit bender available and will fit into most car boots.

ITEM NO.	DESCRIPTION	EAN	MASTER PACK	SHELF PACK
T090700	EL25 Machine & Pipe Vice	0686182000580	-	1
T090700B	EL25 & Vice + 20 / 25mm Formers	0686182000566	-	1
T113100D	EL32 & Vice + 20 / 25 / 32mm Formers	0686182000634	-	1
T090751	Stop bar for EL25	0686182000726	-	1
T620103	Tube stop for EL25, EL32	0686182000702	-	1
T120422	Centre pin for EL25, EL32	0686182000740	-	1
T113112	Bending lever with roller for EL25, EL32	0686182000733	-	1
T102010	Grooved roller for EL25, EL32	0686182000696	-	1
T120465	Roller pin for EL25, EL32	0686182000757	-	1
T090757	Safety pin and chain for EL25, EL32	0686182000689	-	1
T529827	"Terry" retaining pins (in packs of 5 pins) for EL25, EL32	0686182000771	-	1



### CONDUBEND AND SPARE PARTS

The unique IRWIN® Hilmor® Condubend is a 20 & 25mm conduit bender all-in-one. Complete with in-built carrying handle and precision tough aluminium former that makes it an easily portable machine.

ITEM NO.	DESCRIPTION	EAN	MASTER PACK	SHELF PACK
T702025	Condubend (Std Vice)	0686182000795	-	1
T660084	Centre pin and circlips for Condubend	0686182000856	-	1



### CM RANGE COPPER BENDING MACHINES AND SPARE PARTS

The CM range of tube benders are easily portable with in-built carrying handles, they are used with aluminium formers making them the lightest machines available.

ITEM NO.	DESCRIPTION	EAN	MASTER PACK	SHELF PACK
T620100A	CM35 Machine only	0686182002706	-	1
T620100J	CM35 & 15, 22, 28mm Tooling	0686182000078	-	1
T630500A	CM42 Machine only	0686182002843	-	1
T620103	Tube stop for CM35, CM42	0686182000702	-	1
T120422	Centre pin for CM35, CM42	0686182000740	-	1
T630519	Bending lever assembly for CM35, CM42	0686182000900	-	1
T090757	Safety pin and chain for CM35, CM42	0686182000689	-	1
T529827	"Terry" retaining pins (in packs of 5 pins) for CM35, CM42	0686182000771	-	1
T201030	Extension tube for CM42	0686182000931	-	1



### HEAVY-DUTY UNIVERSAL PORTABLE BENDER AND SPARE PARTS

This bender is known for its versatility due to a single universal roller for all forms of pipe. The dual position tube locations are set for copper and conduit, and an adjustable quadrant gives precise repeatable bends.

ITEM NO.	DESCRIPTION	EAN	MASTER PACK	SHELF PACK
TUL223	Universal Portable Bender, Machine Only	0734442144489	6	1
T620103	Tube stop for TUL223	0686182000702	-	1
T220D	Tube locator arm pin with spring for TUL223	0734442171003	-	1











**IRWIN**<sup>®</sup>





# MASONRY DRILLING

## A DRILL BIT FOR EVERY MATERIAL

	SPEEDHAMMER PLUS	SPEEDHAMMER POWER	SPEEDHAMMER MAX	MASONRY	GRANITE	CORDLESS MULTI	GLASS & TILE	DIAMOND	HSS PRO	HSS COBALT	HSS TIN	TCT	TURBOMAX	STEP DRILL	BLUE GROOVE 4X/6X	BLUE GROOVE POWER	AUGER BITS	BRAD POINT
	HAMMER DRILL BITS			ROTARY DRILL BITS					METAL DRILL BITS					WOOD DRILL BITS				
PAGE	85	83	89	93	94	92	95	95	104	101	103	112	99	111	116	115	119	120
<b>MASONRY</b>																		
REBAR REINFORCED CONCRETE	○	●	●		○													
CONCRETE	●	●	●	●	●	○												
NATURAL STONE	●	●	●	●	●	○												
CONCRETE BLOCKS	●	●	●	●	●	○												
AERATED CONCRETE	●	●	●	●	●	●									○	○		
BRICK	●	●	●	●	●	●												
HOLLOW BRICK	○	○	○	●	●	●	○											
ROOF TILE	○	○		○	○	●	○											
GYPSUM BOARD	○	○		●	●	●									○	○		
FIBER CEMENT BOARD	○	○		●	○	●												
GRANITE	○	○	○	●	●	○		●										
MARBLE	○	○	○	○	●	●	○	●										
SLATE	○	○		●	●	●	○	●										
ETERMIT	○	○		●	○	●	●											
CERAMIC TILE				○	○	●	●	●										
HARD DENSITY TILE						●		●										
GLASS						○	●											
<b>WOOD &amp; BOARD MATERIALS</b>																		
SOFT WOOD						●			○	○	○	○	●		●	●	●	●
HARD WOOD						●			○	○	○	○	●		●	●	●	●
NAIL-EMBEDDED WOOD									○	○	○	○	○			●		
CHIPBOARD						●			○	○	○	○	●		○	○	○	●
LAMINATED						●			○	○	○	○	●		○	○	○	●
<b>METAL &amp; PLASTIC</b>																		
MILD STEEL									●	○	●	○	●	●				
HIGH-ALLOYED STEEL									○	●	●	●	○	○				
SHEET METAL						●			●	●	●	○	●	●				
STAINLESS STEEL									○	●	○	○	○	○				
CAST IRON						●			○	●	○	●	○					
ALUMINIUM						●			●	○	●	○	●	●				
NON-FERROUS METAL						●			●	○	●	○	●	●				
PLASTICS						●			●	○	●		●	●				

● = Especially suitable. Recommended for this material.  
○ = Suitable

IRWIN® Drill Bits are available in sets. Go to the Drilling Sets section, starting on page 134, for more details.

IRWIN® now offers a comprehensive line-up of circular saw blades for professional tool users. From the jobsite, to the fine woodworking shop, IRWIN® offers a blade for every user need.



The origins of Joran® go back to May 1944 at which time, good friends Paul Jensen and Herman Reinholdt formed the company Jensen and Reinholdt in Hvidovre, Denmark. They initially began producing masonry drill bits and later in 1955 expanded the production line to hammer drill bits.

Both product lines were characterised by uncompromising quality and were mainly offered to the building and construction industry. IRWIN® is committed to continue the original values of these products by delivering state of the art of Power Tool Accessories. The masonry drill bits range is no exception to this, and continues to fulfill the highest industry standards.

The Joran SPEEDHAMMER™ Plus and SPEEDHAMMER™ Power have the certification of “Prüfgemeinschaft Mauerbohrer” e.V. (PGM), which is the official and independent marking validating the standards of masonry drill bits. The mark is granted only to manufacturers fulfilling the following:

- state-of-the-art manufacturing under use of a quality assurance system
- yearly inspections of the produced drill bits by independent institutes

The inspection requirements are developed by the national approval bodies for anchors in co-operation with leading manufacturers of masonry drill bits and anchors. The Steering Committee of PGM® also carries out appropriate investigations in order to assure the suitability of masonry drill bits for anchor fixings.

New types of drills bits get the inspection mark only after extensive testing has been carried out, ensuring the required suitability and performance.

### HAMMER DRILL BITS



SPEEDHAMMER® POWER



SPEEDHAMMER® PLUS



SPEEDHAMMER® MAX

### ROTARY DRILL BITS



CORDLESS MULTI



MASONRY



GRANITE

### SPECIALITY

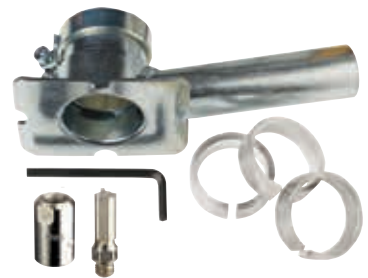

MORTAR RAKES



M-SYSTEM

## SPEEDHAMMER™ POWER



### LONGEST LASTING IRWIN® HAMMER DRILL BIT EVER

The range of SPEEDHAMMER™ Power drill bits is the most powerful masonry bit available from IRWIN®. The unique tip design with 2X more carbide\* is optimised for fast, continuous drilling, even through reinforced concrete, delivering superior performance and 2X longer life\*. The SPEEDHAMMER™ POWER bit has a high-performance tip that's manufactured with 2X more carbide\*. It easily powers through 2X more concrete and rebar than traditional masonry bits. When long life and durability are crucial, depend on the IRWIN® SPEEDHAMMER™ Power Bit.

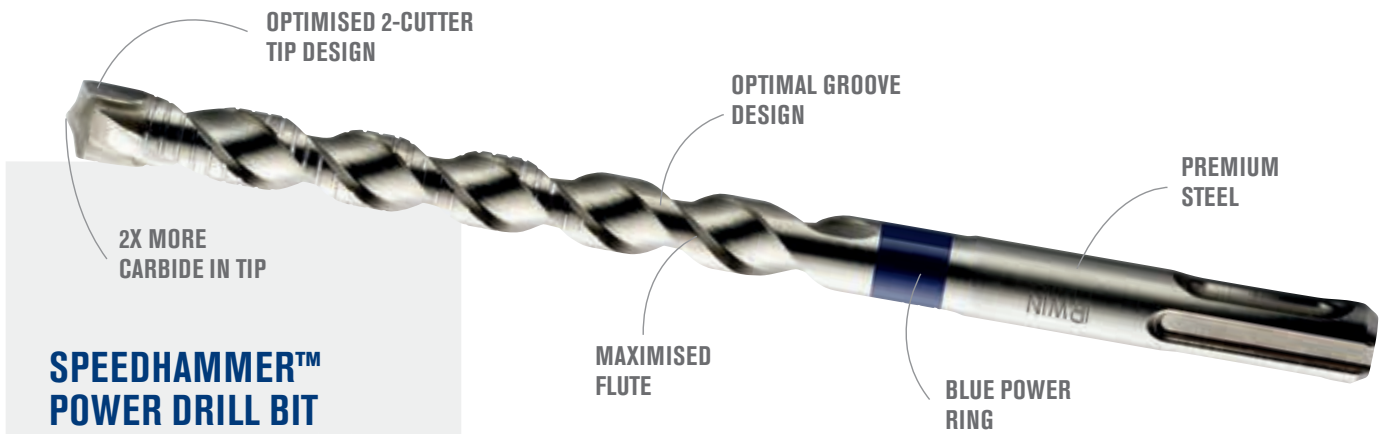

### SPEEDHAMMER™ POWER DRILL BIT



**2X** LONGER LIFE\*

- 1. 2X MORE CARBIDE IN TIP**  
For 2X longer drilling life\* even in rebar-reinforced concrete
- 2. OPTIMISED 2-CUTTER TIP DESIGN**  
For faster drilling, especially through rebar at high speed
- 3. MAXIMISED FLUTE**  
For faster, more efficient dust and debris removal
- 4. PREMIUM STEEL**  
Provides improved core strength for maximum durability and extended life
- 5. BLUE POWER RING**  
For easier identification in the toolbox
- 6. OPTIMAL GROOVE DESIGN**  
Minimises friction for increased speed and longer life

#### APPLICATION:

Compatible with all hammer drilling machines with SDS-plus holder. Optimised for fast, continuous drilling, even through reinforced concrete, delivering superior performance and 2X longer life\*.

#### DRILLING RECOMMENDATION:

When using drill bits with length over 400mm, pre-drill at least 150mm deep with a shorter drill bit of the same diameter.

SPEEDHAMMER™ Power drill bits have the certification of Prüfgemeinschaft Mauerbohrer e.V. (PGM).

#### BENEFITS OF PGM MARKED DRILL BITS:

- Strict tolerance limits for the diameter and the symmetry of the carbide tip ensuring the exactness of the drill hole.
- Secure anchoring and fixing.
- Constant quality assurance.
- Safety and confidence in the product.



Adherence to these criteria is constantly controlled by PGM, making the tool safe and trustworthy for the end user as well as the distributor.

\* vs traditional masonry bits



### SPEEDHAMMER™ POWER DRILL BITS

**SPEED  
POWER  
HAMMER™**



**ALSO  
AVAILABLE  
IN SETS  
SEE PAGE 133**

10507143

ITEM NO.	DIAMETER mm	WORKING LENGTH mm	TOTAL LENGTH mm	PIECE PER PACK	EAN	MASTER PACK	SHELF PACK
10507124	5.0	50	110	1	5706915071245	200	10
10507125	5.0	100	160	1	5706915071252	200	10
10507126	6.0	50	110	1	5706915071269	200	10
10507127	6.0	100	160	1	5706915071276	200	10
10507128	6.0	150	210	1	5706915071283	200	10
10507129	6.0	200	260	1	5706915071290	200	10
10507131	6.5	100	160	1	5706915071313	200	10
10507132	6.5	150	210	1	5706915071320	100	10
10507133	6.5	200	260	1	5706915071337	100	10
10507134	7.0	110	160	1	5706915071344	200	10
10507135	7.0	150	210	1	5706915071351	100	10
10507136	8.0	50	110	1	5706915071368	200	10
10507137	8.0	100	160	1	5706915071375	200	10
10507138	8.0	150	210	1	5706915071382	100	10
10507139	8.0	200	260	1	5706915071399	100	10
10507140	8.0	240	300	1	5706915071405	100	10
10507142	10.0	50	110	1	5706915071429	200	10
10507143	10.0	100	160	1	5706915071436	200	10
10507144	10.0	150	210	1	5706915071443	100	10
10507145	10.0	200	260	1	5706915071450	100	10
10507146	10.0	240	300	1	5706915071467	100	10
10507147	10.0	400	460	1	5706915071474	100	1
10507148	12.0	100	160	1	5706915071481	100	10
10507149	12.0	150	210	1	5706915071498	100	10
10507150	12.0	200	260	1	5706915071504	100	10
10507151	12.0	240	300	1	5706915071511	50	10
10507152	12.0	400	460	1	5706915071528	50	1
10507153	14.0	100	160	1	5706915071535	100	10
10507154	14.0	150	210	1	5706915071542	50	10
10507156	14.0	240	300	1	5706915071566	50	10
10507157	14.0	400	460	1	5706915071573	20	1
10507159	16.0	150	210	1	5706915071597	50	1
10507160	16.0	240	300	1	5706915071603	40	1
10507161	16.0	400	460	1	5706915071610	20	1
10507163	18.0	240	300	1	5706915071634	40	1
10507164	18.0	400	460	1	5706915071641	20	1
10507166	20.0	240	300	1	5706915071665	40	1
10507167	20.0	400	460	1	5706915071672	20	1

## SPEEDHAMMER™ PLUS

**FASTEST IRWIN® HAMMER DRILL BIT EVER**

Set the pace with SPEEDHAMMER™ Plus. With 28% greater flute capacity, the innovative design goes straight in and straight out. It removes dust and debris really fast. And it's particularly effective in uncured concrete due to clog-free performance.

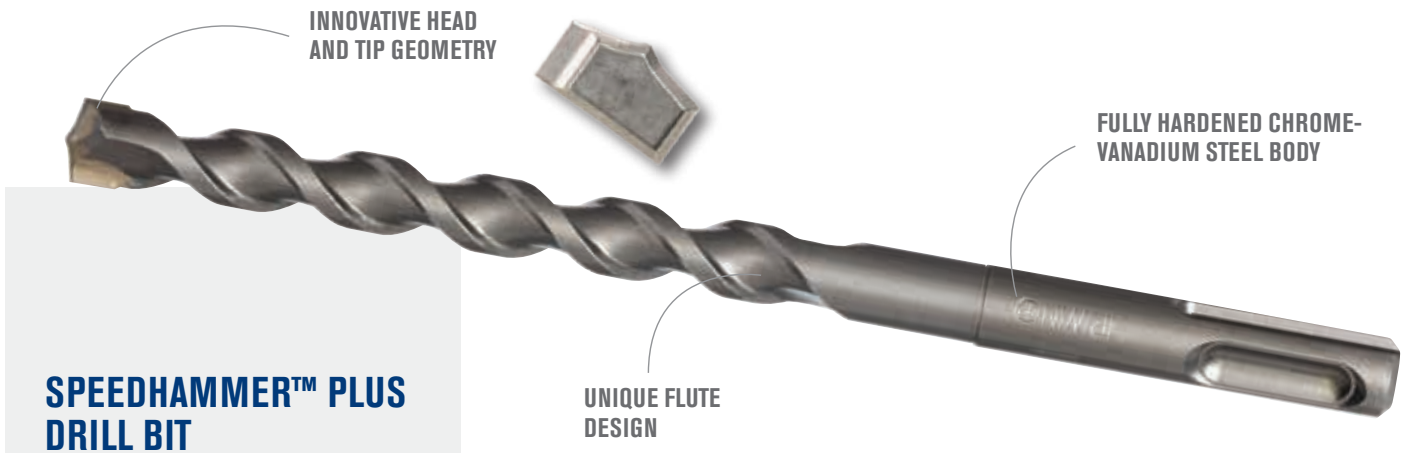

### SPEEDHAMMER™ PLUS DRILL BIT



**20% FASTER\***

#### 1. INNOVATIVE HEAD AND TIP GEOMETRY

25% thicker carbide tip improves strength and durability. Aggressive concave cutting angles increase drilling speed by up to 20%. Extra short drill bit head clears drilling dust directly into the flute, reducing the risk of clogging. Self-centering point prevents walking

#### 2. UNIQUE FLUTE DESIGN

New extra deep, asymmetrical flute design provides faster dust removal and increases drilling speed

#### 3. FULLY HARDENED CHROME-VANADIUM STEEL BODY

Resulting in maximum rupture strength and longer life



2-Cutter Head



4-Cutter Head

#### APPLICATION:

Compatible with all hammer drilling machines with SDS-plus holder. Designed for drilling in concrete, masonry, brick, block, and granite.

#### DRILLING RECOMMENDATION:

When using drill bits with length over 400mm, pre-drill at least 150mm deep with a shorter drill bit of the same diameter.

SPEEDHAMMER™ Plus drill bits have the certification of Prüfgemeinschaft Mauerbohrer e.V. (PGM).

#### BENEFITS OF PGM MARKED DRILL BITS:

- Strict tolerance limits for the diameter and the symmetry of the carbide tip ensuring the exactness of the drill hole.
- Secure anchoring and fixing.
- Constant quality assurance.
- Safety and confidence in the product.



Adherence to these criteria is constantly controlled by PGM, making the tool safe and trustworthy for the end user as well as the distributor.

\* Up to 20% faster drilling vs. competitor products due to tip geometry and innovative flute design.

### SPEEDHAMMER™ PLUS DRILL BITS

**SPEED  
PLUS  
HAMMER™**



10501979

ITEM NO.	DIAMETER mm	WORKING LENGTH mm	TOTAL LENGTH mm	PIECE PER PACK	EAN	MASTER PACK	SHELF PACK
10501941	3.0	50	110	1	5709131203599	200	10
10507574	3.0	80	140	1	5706915075748	200	10
10501942	3.5	50	110	1	5709131061656	200	10
10507575	3.5	80	140	1	5706915075755	100	10
10501943	4.0	50	110	1	5709131019282	200	10
10501944	4.0	100	160	1	5709131019350	200	10
10503844	4.5	100	160	1	734442175582	200	10
10501945	5.0	50	110	1	5709131019466	200	10
10501946	5.0	100	160	1	5709131019800	200	10
10501947	5.0	150	210	1	5709131236962	100	10
10501948	5.0	200	260	1	5709131204237	100	10
10501949	5.5	50	110	1	5709131020011	200	10
10501950	5.5	100	160	1	5709131020233	200	10
10501951	5.5	150	210	1	5709131020363	100	10
10501952	5.5	200	260	1	5709131281030	100	10
10501953	5.5	240	300	1	5709131236986	100	10
10501954	6.0	50	110	1	5709131020400	200	10
10501955	6.0	100	160	1	5709131020769	200	10
10501956	6.0	150	210	1	5709131021070	100	10
10501957	6.0	200	260	1	5709131021124	100	10
10501958	6.0	240	300	1	5709131236948	100	10
10501959	6.0	400	460	1	5709131021162	50	10
10501960	6.5	50	110	1	5709131021186	200	10
10501961	6.5	100	160	1	5709131021353	200	10
10501962	6.5	150	210	1	5709131021537	100	10
10501963	6.5	200	260	1	5709131021544	100	10
10501964	7.0	50	110	1	5709131021582	200	10
10501965	7.0	100	160	1	5709131021704	200	10
10501966	7.0	150	210	1	5709131021919	100	10
10501967	7.0	340	400	1	5709131228929	50	10
10501968	8.0	50	110	1	5709131021971	200	10
10501969	8.0	100	160	1	5709131022305	200	10
10501970	8.0	150	210	1	5709131022701	100	10
10501971	8.0	200	260	1	5709131022947	100	10
10501972	8.0	240	300	1	5709131023029	100	10
10501973	8.0	400	460	1	5709131023142	50	10
10501974	8.0	540	600	1	5709131023227	50	1
10501975	9.0	100	160	1	5709131023364	200	10
10501976	9.0	150	210	1	5709131023449	100	10
10501978	10.0	50	110	1	5709131023524	200	10
10501979	10.0	100	160	1	5709131023722	200	10
10501980	10.0	150	210	1	5709131024095	100	10
10501981	10.0	200	260	1	5709131024378	100	10
10501982	10.0	240	300	1	5709131024484	100	10
10501984	10.0	400	460	1	5709131024620	50	10
10501985	10.0	540	600	1	5709131024750	50	1
10501986	10.0	940	1000	1	5709131135418	20	1
10501987	11.0	100	160	1	5709131024866	100	10
10501988	11.0	200	260	1	5709131025047	50	10
10501989	11.0	240	300	1	5709131025061	50	10
10501991	12.0	100	160	1	5709131025153	100	10
10501992	12.0	150	210	1	5709131025498	100	10
10501993	12.0	170	230	1	5709131025610	100	10
10501994	12.0	200	260	1	5709131025689	100	10
10501995	12.0	240	300	1	5709131025771	50	10
10501996	12.0	400	460	1	5709131025917	50	10
10501997	12.0	540	600	1	5709131026044	20	1
10501998	12.0	740	800	1	5709131026105	20	1
10501999	12.0	940	1000	1	5709131026112	20	1
10502000	13.0	100	160	1	5709131026280	100	10
10502002	13.0	240	300	1	5709131026488	50	10
10502004	14.0	100	160	1	5709131026624	100	10
10502005	14.0	150	210	1	5709131026778	50	1
10502006	14.0	170	230	1	5709131026846	50	1
10502007	14.0	200	260	1	5709131026907	50	1



# MASONRY DRILLING

## SPEEDHAMMER™ PLUS DRILL BITS

ITEM NO.	DIAMETER mm	WORKING LENGTH mm	TOTAL LENGTH mm	PIECE PER PACK	EAN	MASTER PACK	SHELF PACK
10502008	14.0	240	300	1	5709131026983	50	1
10502010	14.0	400	460	1	5709131027058	20	1
10502011	14.0	540	600	1	5709131027188	20	1
10502012	14.0	940	1000	1	5709131137610	20	1
10502013	15.0	100	160	1	5709131027331	100	1
10502014	15.0	170	230	1	5709131027492	50	1
10502015	15.0	200	260	1	5709131027539	50	1
10502016	15.0	240	300	1	5709131027584	40	1
10502017	16.0	100	160	1	5709131027713	100	1
10502018	16.0	150	210	1	5709131027829	50	1
10502019	16.0	170	230	1	5709131027959	50	1
10502020	16.0	240	300	1	5709131028055	40	1
10502021	16.0	400	460	1	5709131028154	20	1
10502022	16.0	540	600	1	5709131028314	20	1
10502023	16.0	740	800	1	5709131028383	20	1
10502024	16.0	940	1000	1	5709131028413	10	1
10502025	17.0	150	210	1	5709131028475	50	1
10502027	18.0	150	210	1	5709131028635	50	1
10502028	18.0	240	300	1	5709131028857	40	1
10502029	18.0	400	460	1	5709131028925	20	1
10502030	18.0	540	600	1	5709131029038	20	1
10502031	18.0	940	1000	1	5709131096290	10	1
10502033	19.0	240	300	1	5709131029205	40	1
10502035	19.0	400	460	1	5709131029267	20	1
10502036	20.0	150	210	1	5709131029373	50	1
10502038	20.0	240	300	1	5709131029595	40	1
10502040	20.0	400	460	1	5709131029670	20	1
10502041	20.0	540	600	1	5709131029823	10	1
10502042	20.0	940	1000	1	5709131097129	10	1
10502043	22.0	200	260	1	5709131029939	25	1
10502044	22.0	240	300	1	5709131030003	40	1
10502046	22.0	400	460	1	5709131030126	10	1
10502047	22.0	540	600	1	5709131030263	10	1
10502048	22.0	940	1000	1	5709131097594	10	1
10502049	24.0	200	260	1	5709131030331	10	1
10502050	24.0	240	300	1	5709131030386	20	1
10502052	24.0	400	460	1	5709131030478	10	1
10502053	25.0	200	260	1	5709131030584	10	1
10502054	25.0	240	300	1	5709131030638	20	1
10502056	25.0	400	460	1	5709131030720	10	1
10502057	25.0	550	600	1	5709131258483	5	1
10502059	26.0	240	300	1	5709131030898	20	1
10502060	26.0	400	460	1	5709131030942	10	1
10502061	26.0	540	600	1	5709131128397	10	1



## SPEEDHAMMER™ PLUS DRILL BITS - 4 CUTTING EDGES

ITEM NO.	DIAMETER mm	WORKING LENGTH mm	TOTAL LENGTH mm	PIECE PER PACK	EAN	MASTER PACK	SHELF PACK
10502069	28.0	400	450	1	5709131184553	5	1
10502070	30.0	400	450	1	5709131184577	3	1



### SPEEDHAMMER™ PLUS DRILL BITS - BULK PACK

**SPEED  
PLUS  
HAMMER™**



10502085

ITEM NO.	DIAMETER mm	WORKING LENGTH mm	TOTAL LENGTH mm	PIECE PER PACK	EAN	MASTER PACK	SHELF PACK
<b>5-PIECE PACKS</b>							
10503603	5.0	50	110	5	5709131286172	1	1
10503605	6.0	50	110	5	5709131286202	1	1
10503606	6.0	100	160	5	5709131285991	1	1
10503607	6.0	150	210	5	5709131286028	1	1
10503609	8.0	50	110	5	5709131280231	1	1
10503610	8.0	100	160	5	5709131286110	1	1
10503611	8.0	150	210	5	5709131286080	1	1
10503612	10.0	100	160	5	5709131286141	1	1
10503613	10.0	150	210	5	5709131286325	1	1
<b>10-PIECE PACKS</b>							
10502071	5.0	50	110	10	5709131176206	30	1
10502072	5.0	100	160	10	5709131176220	30	1
10502073	5.5	50	110	10	5709131176244	30	1
10502074	5.5	100	160	10	5709131176268	30	1
10502075	6.0	50	110	10	5709131176282	30	1
10502076	6.0	100	160	10	5709131176305	1	1
10502077	6.0	150	210	10	5709131228943	30	1
10502080	6.5	150	210	10	5709131230823	20	1
10503845	7.0	100	160	10	734442175827	20	1
10502082	8.0	100	160	10	5709131176404	30	1
10502083	8.0	150	210	10	5709131176428	30	1
10502084	10.0	50	110	10	5709131176442	20	1
10502085	10.0	100	160	10	5709131253341	30	1
10502086	10.0	150	210	10	5709131176480	25	1
10502087	12.0	100	160	10	5709131176503	25	1
10502088	12.0	150	210	10	5709131230199	25	1

## SPEEDHAMMER™ MAX

DESIGNED FOR TOUGHER TASKS

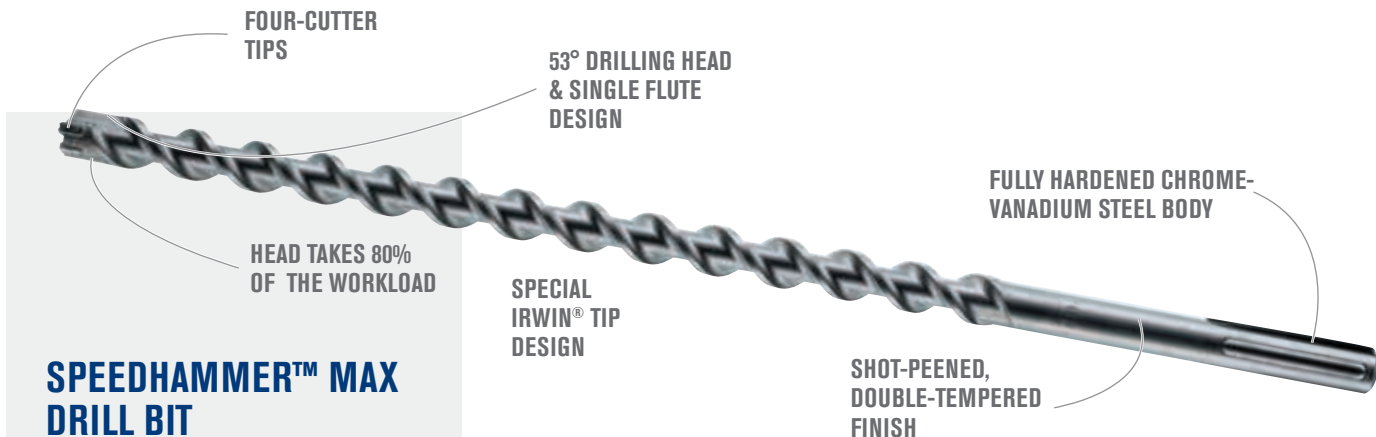

### SPEEDHAMMER™ MAX DRILL BIT



- 1. SPECIAL IRWIN® TIP DESIGN**  
Enhances dust removal and produces symmetrical holes
- 2. HEAD TAKES 80% OF THE WORKLOAD**  
Ensuring higher durability, speed and steel reinforced bar (Rebar) drilling performance
- 3. 53° DRILLING HEAD & SINGLE FLUTE DESIGN**  
Means more aggressive cutting and 30% faster dust removal for overall faster drilling
- 4. FOUR-CUTTER TIPS**  
For less vibration, faster drilling, rounder holes and better anchoring
- 5. FULLY HARDENED CHROME-VANADIUM STEEL BODY**  
For maximum strength and life
- 6. SHOT-PEENED, DOUBLE-TEMPERED FINISH**  
For increased wear resistance and extended life  
Shank fits in all SDS Max Hammer Machines

### SPEEDHAMMER™ MAX DRILL BITS 2 CUTTING EDGES

ITEM NO.	DIAMETER mm	WORKING LENGTH mm	TOTAL LENGTH mm	PIECE PER PACK	EAN	MASTER PACK	SHELF PACK
10502092	12.0	200	340	1	5709131233756	25	1
10502093	12.0	400	540	1	5709131233770	10	1
10502094	12.0	550	690	1	5709131233794	10	1
10502095	14.0	200	340	1	5709131233817	25	1
10502096	14.0	400	540	1	5709131233831	10	1
10502097	15.0	200	340	1	5709131233855	25	1
10502098	15.0	400	540	1	5709131233879	10	1



### SPEEDHAMMER™ MAX DRILL BITS 4 CUTTING EDGES



10502113

ITEM NO.	DIAMETER mm	WORKING LENGTH mm	TOTAL LENGTH mm	PIECE PER PACK	EAN	MASTER PACK	SHELF PACK
10502099	16.0	200	340	1	5709131233893	25	1
10502100	16.0	400	540	1	5709131233916	10	1
10502101	18.0	200	340	1	5709131233930	25	1
10502102	18.0	400	540	1	5709131233954	10	1
10502103	20.0	200	320	1	5709131233978	25	1
10502104	20.0	400	520	1	5709131233992	10	1
10502105	20.0	800	920	1	5709131234012	5	1
10502106	22.0	200	320	1	5709131234036	25	1
10502107	22.0	400	520	1	5709131234050	10	1
10502108	22.0	800	920	1	5709131234074	5	1
10502109	24.0	200	320	1	5709131234098	10	1
10502110	24.0	400	520	1	5709131234111	5	1
10502111	25.0	200	320	1	5709131234135	10	1
10502112	25.0	400	520	1	5709131234159	5	1
10502113	25.0	800	920	1	5709131234173	5	1
10502115	28.0	250	370	1	5709131234197	5	1
10502116	28.0	450	570	1	5709131234210	5	1
10502117	28.0	550	670	1	5709131234234	5	1
10502118	30.0	250	370	1	5709131234241	3	1
10502119	30.0	450	570	1	5709131234272	3	1
10502120	32.0	250	370	1	5709131234296	3	1
10502121	32.0	450	570	1	5709131234319	3	1
10502122	32.0	800	920	1	5709131234333	3	1
10502123	35.0	250	370	1	5709131234340	3	1
10502124	35.0	450	570	1	5709131234364	3	1
10502125	35.0	550	670	1	5709131234388	2	1
10502126	38.0	250	370	1	5709131234395	2	1
10502127	38.0	450	570	1	5709131234401	2	1
10502128	40.0	250	370	1	5709131234418	2	1
10502129	40.0	430	570	1	5709131234425	2	1
10502130	40.0	780	920	1	5709131234647	2	1

## DEMOLITION CHISELS

### POINTED CHISEL



For general chiselling and breaking work in brick, concrete and loose stone (eg: when laying cables)

### FLAT CHISEL



For general chiselling and breaking work in brick, concrete and loose stone (eg: when laying cables)

### SPADE CHISEL



For removing large quantities of material

### GOUGE CHISEL



For cutting narrow channels into concrete

### TCT POINTING CHISEL



For the removal of pointing in brickwork

### CRANKED TILE CHISEL



For easy removal of tiles

**ALSO AVAILABLE IN SETS**  
SEE PAGE 133

### SPEEDHAMMER™ PLUS DEMOLITION CHISELS

ITEM NO.	DESCRIPTION	EAN	MASTER PACK	SHELF PACK
10502194	Pointed Chisel 250mm	5709131281979	-	1
10502195	Flat Chisel 20 x 250mm	5709131281986	-	1
10502196	Spade Chisel 40 x 250mm	5709131281993	-	1
10502197	Gouge Chisel 22 x 250mm	5709131282006	-	1
10502198	TCT Pointing Chisel 32 x 125mm	5709131285595	-	1
10502200	TCT Pointing Chisel 32 x 200mm	5709131285601	-	1
10503643	Cranked Tile Chisel 40 x 250mm	5706915001273	-	1

**DESIGNED FOR A WIDE RANGE OF APPLICATIONS** for both SDS Plus and SDS Max hammer drills: breaking through or breaking up concrete, light demolition work and chasing of channels for pipes and electrical conduit  
**IDEAL FOR DRILLING** in concrete and masonry  
**HIGH-QUALITY ALLOYED STEEL** is precision hardened for optimum performance and life

### SPEEDHAMMER™ MAX DEMOLITION CHISELS

ITEM NO.	DESCRIPTION	EAN	MASTER PACK	SHELF PACK
10502184	Pointed Chisel 280mm	5709131281870	-	1
10502185	Pointed Chisel 400mm	5709131281887	-	1
10502186	Pointed Chisel 600mm	5709131281894	-	1
10502187	Flat Chisel 25 x 280mm	5709131281900	-	1
10502188	Flat Chisel 25 x 400mm	5709131281917	-	1
10502189	Flat Chisel 25 x 600mm	5709131281924	-	1
10502190	Spade Chisel 115 x 350mm	5709131281931	-	1
10502191	Spade Chisel 50 x 400mm	5709131281948	-	1
10502192	Spade Chisel 80 x 300mm	5709131281955	-	1
10503644	Cranked Tile Chisel 50 x 400mm	5706915001297	-	1



# HEAVY-DUTY CORE DRILLS



### SPEEDHAMMER™ MAX DRILL BITS 2 CUTTING EDGES

	ITEM NO.	DESCRIPTION	HOLE DIAMETER mm	LENGTH mm	PIECE PER PACK	EAN	MASTER PACK	SHELF PACK
<b>DESIGNED FOR DRILLING LARGE DIAMETERS</b> (35-150mm) into concrete, granite and other very hard materials <b>FOR EASY PILOT DRILL REMOVAL</b> push the drift key into the slot of the drill rod	10507198	Drill Rod 180mm SPDHMAX	-	180	1	5706915071986	50	1
	10507199	Drill Rod 450mm SPDHMAX	-	450	1	5706915071993	20	1
	10507200	Drill Rod 115mm SPDHPLUS	-	115	1	5706915072006	80	1
	10507211	HD Core Drill 40mm	40	100	1	5706915072112	20	1
	10507212	HD Core Drill 45mm	45	100	1	5706915072129	20	1
	10507213	HD Core Drill 50mm	50	100	1	5706915072136	20	1
	10507214	HD Core Drill 60mm	60	100	1	5706915072143	15	1
	10507215	HD Core Drill 65mm	65	100	1	5706915072150	15	1
	10507216	HD Core Drill 75mm	75	100	1	5706915072167	8	1
	10507217	HD Core Drill 80mm	80	100	1	5706915072174	8	1
	10507218	HD Core Drill 90mm	90	100	1	5706915072181	6	1
	10507219	HD Core Drill 100mm	100	100	1	5706915072198	6	1
	10507220	HD Core Drill 115mm	115	100	1	5706915072204	4	1
	10507221	HD Core Drill 125mm	125	100	1	5706915072211	4	1
	10507222	HD Core Drill 150mm	150	100	1	5706915072228	3	1
	10507224	Pilot Drill Bit 11 x 120mm	11	120	1	5706915072242	200	1
	10507225	Core Drill Drift Key	-	-	1	5706915072259	200	1



## CORDLESS MULTI DRILL BITS



### ONE DRILL BIT FOR EVERY MATERIAL

The Cordless Multi drill bit is IRWIN®'s most versatile drill bit. It is designed to drill in multiple materials including brick, light concrete, dry wall, ceramic tiles, sheet metal, wood, plastic and marble. In addition to the multipurpose function, the Cordless Multi is IRWIN®'s problem solver for drilling into ceramic tiles up to a hardness grade of 9.

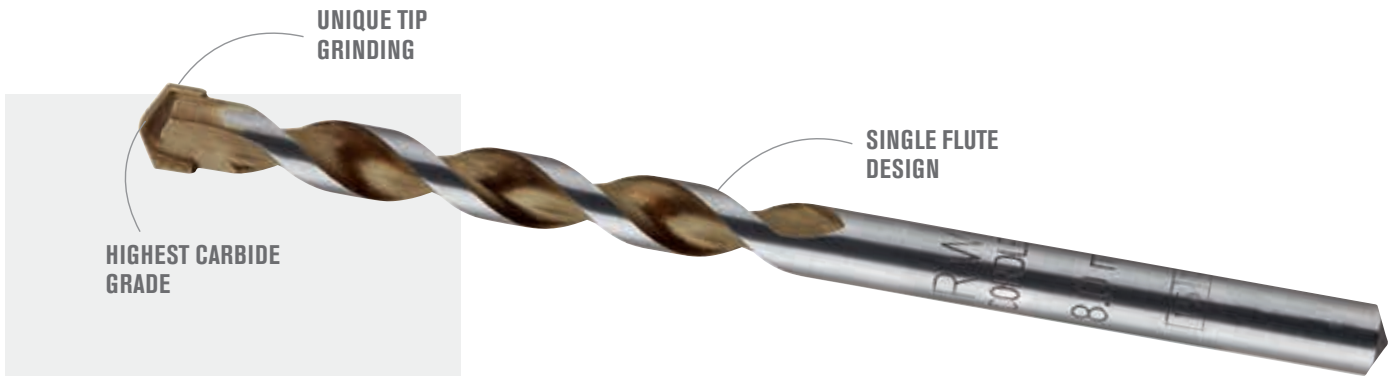

### CORDLESS MULTI



#### 1. HIGHEST CARBIDE GRADE

For fast drilling into most common materials and hardest tiles (scratch hardness 9)

#### 2. SINGLE FLUTE DESIGN

Giving maximum space for dust removal. Up to 15% Speed advantage over competition. 10% more holes per battery charge

#### 3. UNIQUE TIP GRINDING

Brazed carbide tip has a unique diamond ground 4-face design for excellent centering and perfect hole quality

#### USEFUL TIPS:

1. Drill with low RPM
2. High pressure
3. No hammer action



### CORDLESS MULTI-DRILL BITS - ROTARY DRILLING ONLY

ITEM NO.	DIAMETER mm	WORKING LENGTH mm	TOTAL LENGTH mm	SHANK DIAMETER mm	EAN	MASTER PACK	SHELF PACK
10501919	3.0	40	110	CYL as Ø	5709131285731	200	10
10501920	3.5	40	110	CYL as Ø	5709131285762	200	10
10501921	4.0	45	80	CYL as Ø	5709131000303	200	10
10501922	5.0	50	90	CYL as Ø	5709131000563	200	10
10501923	5.5	55	95	CYL as Ø	5709131000822	200	10
10501924	5.5	115	160	CYL as Ø	5709131055037	200	10
10501925	6.0	60	100	CYL as Ø	5709131000983	200	10
10501926	6.0	115	160	CYL as Ø	5709131001164	200	10
10501927	6.0	120	200	CYL as Ø	5709131247593	100	10
10501928	6.5	60	105	CYL as Ø	5709131001348	200	10
10501929	6.5	120	200	CYL as Ø	5709131243007	100	10
10501930	7.0	65	110	CYL as Ø	5709131001577	200	10
10501931	7.0	115	160	CYL as Ø	5709131001720	200	10
10501932	8.0	70	120	CYL as Ø	5709131001836	200	10
10501933	8.0	120	200	CYL as Ø	5709131002086	100	10
10501934	10.0	70	140	CYL as Ø	5709131002710	200	10
10501935	10.0	120	200	CYL as Ø	5709131002918	100	10
10501936	12.0	105	160	CYL as Ø	5709131003267	50	10
10501937	14.0	100	160	10	5709131003717	50	10



10501931

ALSO AVAILABLE IN SETS SEE PAGE 134

# MASONRY DRILL BITS

FASTEST AND LONGEST LASTING MASONRY DRILL BIT

MASONRY



### MASONRY DRILL BITS - ROTARY PERCUSSION

**IMPROVED CARBIDE TIP DESIGN** ensures for durability and fast drilling in all masonry materials  
**AGGRESSIVE HEAD DESIGN** for up to 15% speed advantage over competition  
**UNIQUE BRAZING PROCESS** ensures a perfect bond between tip and body  
**SINGLE FLUTE DESIGN** gives maximum space for dust removal and provides a 60% faster dust removal

**20% LONGER LIFE\***

**ALSO AVAILABLE IN SETS**  
SEE PAGE 134



10501830

ITEM NO.	DIAMETER mm	WORKING LENGTH mm	TOTAL LENGTH mm	SHANK DIAMETER mm	EAN	MASTER PACK	SHELF PACK
10501812	3.0	45	75	CYL as Ø	5709131000129	200	10
10501813	3.5	45	75	CYL as Ø	5709131000211	200	10
10501814	4.0	45	75	CYL as Ø	5709131055839	200	10
10501815	4.0	90	150	CYL as Ø	5709131055075	200	10
10501816	4.5	45	85	CYL as Ø	5709131000488	200	10
10501817	5.0	50	90	CYL as Ø	5709131055846	200	10
10501818	5.0	90	150	CYL as Ø	5709131000778	200	10
10501819	5.5	50	90	CYL as Ø	5709131055853	200	10
10501820	5.5	90	150	CYL as Ø	5709131000952	200	10
10501821	6.0	60	100	CYL as Ø	5709131055860	200	10
10501822	6.0	90	150	CYL as Ø	5709131055877	200	10
10501823	6.0	280	330	CYL as Ø	5709131001225	100	1
10501824	6.0	300	400	CYL as Ø	5709131001249	50	1
10501826	6.5	60	100	CYL as Ø	5709131055884	200	10
10501827	6.5	90	150	CYL as Ø	5709131001461	50	10
10501830	7.0	60	100	CYL as Ø	5709131055891	200	10
10501831	7.0	90	150	CYL as Ø	5709131055907	200	10
10501834	8.0	70	120	CYL as Ø	5709131055914	200	10
10501835	8.0	90	150	CYL as Ø	5709131002055	200	10
10501836	8.0	130	200	CYL as Ø	5709131055921	100	10
10501837	8.0	240	330	CYL as Ø	5709131002130	100	1
10501838	8.0	300	400	CYL as Ø	5709131002147	50	1
10501841	9.0	70	120	CYL as Ø	5709131002352	200	10
10501846	10.0	70	120	CYL as Ø	5709131055938	200	10
10501847	10.0	90	150	CYL as Ø	5709131002871	200	10
10501848	10.0	130	200	CYL as Ø	5709131055945	100	10
10501849	10.0	240	330	CYL as Ø	5709131002963	100	1
10501850	10.0	300	400	CYL as Ø	5709131002987	50	1
10501853	11.0	90	150	CYL as Ø	5709131003106	50	10
10501854	12.0	90	150	10	5709131055952	50	10
10501855	12.0	240	330	10	5709131003397	30	1
10501856	12.0	300	400	10	5709131003403	30	1
10501859	13.0	90	150	10	5709131003526	30	10
10501862	14.0	90	150	10	5709131055969	50	10
10501863	14.0	240	330	10	5709131003762	30	1
10501864	14.0	300	400	10	5709131003786	30	1
10501866	15.0	90	150	10	5709131003878	50	1
10501867	16.0	90	150	10	5709131003915	15	1
10501869	16.0	300	400	13	5709131003991	15	1
10501873	18.0	95	160	13	5709131004158	50	1
10501874	18.0	300	400	13	5709131004172	15	1
10501877	19.0	300	400	13	5709131004295	10	1
10501878	20.0	95	160	13	5709131004325	10	1
10501880	20.0	300	400	13	5709131004356	10	1
10501882	22.0	95	160	13	5709131004424	50	1
10501884	22.0	300	400	13	5709131004486	10	1
10501885	24.0	95	160	13	5709131004530	25	1
10501886	24.0	300	400	13	5709131004554	5	1
10501888	26.0	80	160	13	5709131004608	25	1

\* vs traditional masonry bits

## GRANITE DRILL BITS

DESIGNED FOR PERCUSSION DRILLING IN VERY HARD MATERIALS

**GRANITE**



### GRANITE DRILL BITS - ROTARY PERCUSSION

ITEM NO.	DIAMETER mm	WORKING LENGTH mm	TOTAL LENGTH mm	SHANK DIAMETER mm	EAN	MASTER PACK	SHELF PACK
10501894	3.0	40	70	CYL as Ø	5709131008095	200	10
10501895	3.5	40	75	CYL as Ø	5709131008101	200	10
10501896	4.0	45	80	CYL as Ø	5709131008118	200	10
10501897	5.0	50	90	CYL as Ø	5709131008163	200	10
10501898	5.0	115	160	CYL as Ø	5709131008187	200	10
10501899	5.5	55	95	CYL as Ø	5709131008200	200	10
10501901	6.0	60	100	CYL as Ø	5709131008231	200	10
10501902	6.0	115	160	CYL as Ø	5709131008255	200	10
10501903	6.5	60	105	CYL as Ø	5709131008293	200	10
10501905	7.0	60	110	CYL as Ø	5709131008323	200	10
10501906	7.0	115	160	CYL as Ø	5709131008347	200	10
10501907	8.0	70	120	CYL as Ø	5709131008378	200	10
10501908	8.0	130	200	CYL as Ø	5709131008392	100	10
10501910	9.0	70	130	CYL as Ø	5709131008446	200	10
10501911	10.0	70	140	CYL as Ø	5709131008460	200	10
10501912	10.0	130	200	CYL as Ø	5709131008491	100	10
10501913	11.0	105	160	CYL as Ø	5709131008545	50	10
10501914	12.0	105	160	CYL as Ø	5709131008552	50	10
10501915	13.0	100	160	10	5709131008606	50	10
10501916	14.0	100	160	10	5709131008613	50	10

FOR PERCUSSION DRILLING in very hard materials such as granite  
**EXTREMELY HARD AND WEAR RESISTANT CARBIDE** guarantees up to 40% more holes compared to conventional masonry drill bits  
**STONE MASONS** favour this product for impact drilling of natural stone like granite  
**SPECIAL SHAPED CUTTING EDGES** mean higher durability resulting in 50% more accurately sized holes per drill bit



**ALSO AVAILABLE IN SETS**  
SEE PAGE 134

10501901



# GLASS AND TILE BITS

GLASS & TILES

## FOR DRILLING GLASS, TILE AND CERAMICS

Carbide spear-point tip cuts clean, round holes with minimised chipping in glass, tile and ceramic.



### USEFUL TIPS:

1. Drill with low RPM
2. High pressure
3. No hammer action
4. Not suitable for use on toughened glass or porcelain

ITEM NO.	DESCRIPTION	EAN	MASTER PACK	SHELF PACK
10507903	Glass & Tile 4mm	5706915079036	200	10
10507904	Glass & Tile 5mm	5706915079043	200	10
10507905	Glass & Tile 6mm	5706915079050	200	10
10507906	Glass & Tile 7mm	5706915079067	200	10
10507907	Glass & Tile 8mm	5706915079074	200	10
10507909	Glass & Tile 10mm	5706915079098	200	10



# DIAMOND DRILL BITS

DIAMOND

## FOR FAST, SMOOTH CUTTING IN ALL GRADES OF HARD AND SOFT TILES



10507896

ITEM NO.	DESCRIPTION	EAN	MASTER PACK	SHELF PACK
10507892	Diamond Drill BIT 5mm	5706915078923	60	1
10507893	Diamond Drill BIT 6mm	5706915078930	60	1
10507894	Diamond Drill BIT 7mm	5706915078947	60	1
10507895	Diamond Drill BIT 8mm	5706915078954	60	1
10507896	Diamond Drill BIT 10mm	5706915078961	60	1
10507897	Diamond Drill BIT 12mm	5706915078978	60	1
10507898	Diamond Drill BIT 14mm	5706915078985	60	1

### USEFUL TIPS:

1. Drilling with water increases the lifespan of the tool.
2. Do not press strongly on the tool, let it work.
3. Make a swinging movement to allow dust evacuation.
4. Cutting speed: 2700 RPM.
5. No hammer action.



The drill needs to run before hitting the surface. To avoid sliding of the drill, start with an angle of 45°.



Once the hole has started, raise the drill gradually up to the vertical line.



Make an oscillating movement while drilling.



## MORTAR RAKES

The Mortar Rake is designed to replace traditional methods of mortar removal such as powered mortar chisels and cutting discs. The rake is faster and less intrusive to surrounding brickwork and, unlike other methods, it is just as efficient for both horizontal and vertical joint clearing.

Please note that the cutters must be used together with an adaptor (10507234) and angle grinder.



ITEM NO.	DESCRIPTION	EAN	MASTER PACK	SHELF PACK
10507229	8,0 x 20/40mm, 3 cutter, (2 pcs.)	5706915072297	50	5
10507230	10,0 x 20/40mm, 3 cutter (2 pcs.)	5706915072303	50	5
10507231	12,0 x 20/40mm, 3 cutter, (2 pcs.)	5706915072310	50	5
10507232	8,0 x 20/40mm, 4 cutter, (2 pcs.)	5706915072327	50	5
10507233	10,0 x 20/40mm, 4 cutter (2 pcs.)	5706915072334	50	5
10507234	Adapter	5706915072341	50	5
10502880	Sole plate U500	5709131266488	15	1
10507267	Starter kit 8mm 1 pc. sole plate, 2 pcs. 8,0mm 3 cutter - 1 pc. adaptor	5706915072679	15	1
10507268	Starter kit 10mm 1 pc. sole plate 2 pcs. 10mm 3 cutter - 1 pc. adaptor	5706915072686	15	1

## M-SYSTEM

**M-SYSTEM**



### HOW IT WORKS

1. Push the body backwards and start drilling.  
New IRWIN® Carbide Tip Design ensures an easy start on fibre cement.
2. After drilling the hole pull back the pilot drill and fix the hexagon-screw with the same tool.
3. Special spring to keep the screw in place before fixing.  
No more adapters or additional power tools required for roofing applications.  
For more convenient and safer work.

ITEM NO.	DESCRIPTION	EAN	MASTER PACK	SHELF PACK
10507590	M-System 8 mm	5706915075908	30	5
10502865	M-System 11 mm	5709131054276	15	1
10503476	8 mm Drill Bit for M-System	5709131054290	200	10
10507937	11 mm Drill Bit for M-System	5706915079371	200	10

**2-IN-1 TOOL DESIGN** for easy and fast fixing of fibre cement and similar roofing/panelling materials  
**IMPROVED CARBIDE TIP** ensures easy starts  
**SPECIAL SPRING** keeps the screw in place before fixing

**IRWIN®**

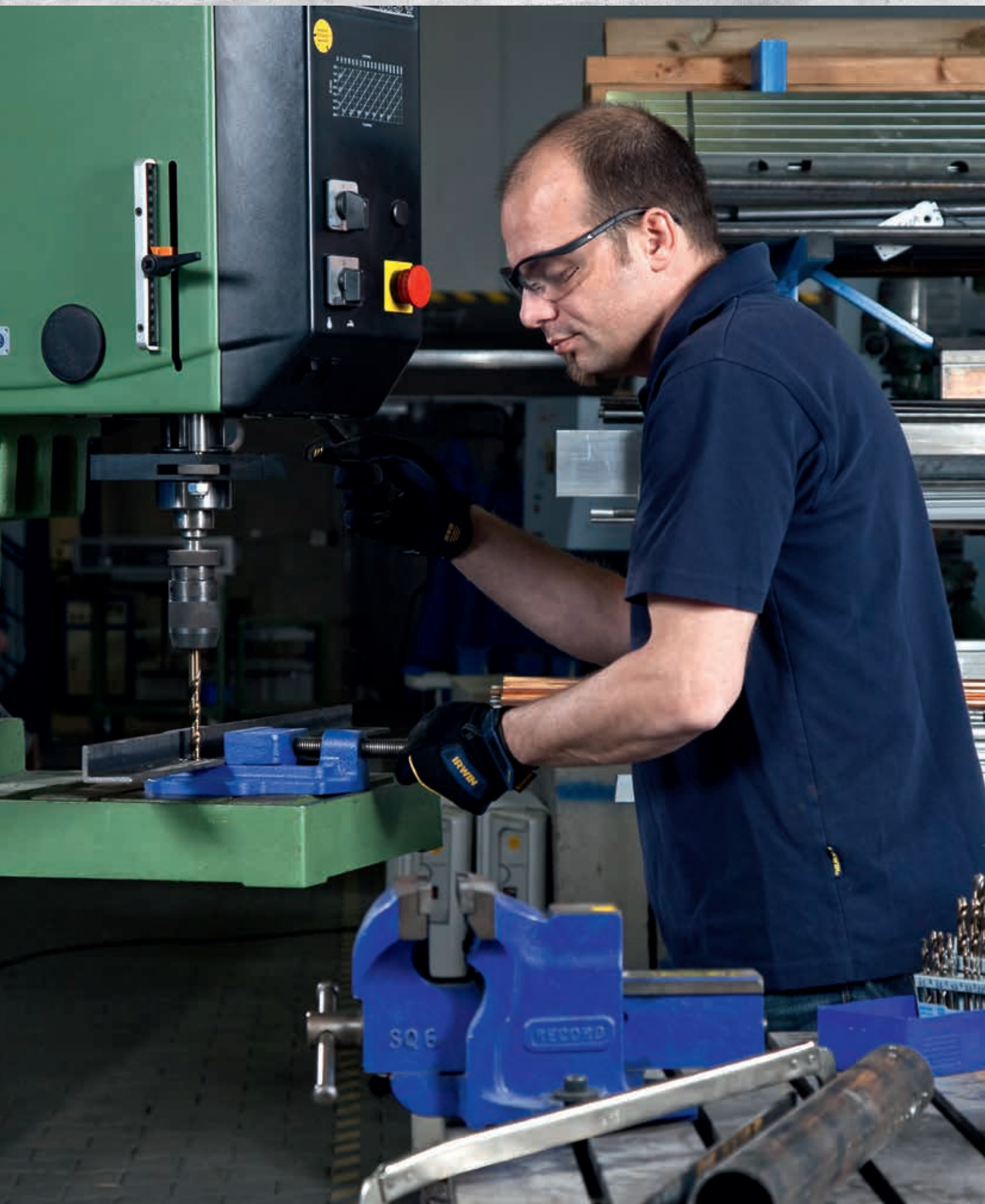



## ENGINEERED FOR CONTROLLED PRECISION AND SPEED

The IRWIN® line of metal drill bits offers of a solution for every professional application. Each metal drill bit is made of high speed steel with high precision-cut point and spiral, ensuring durability and quality.

**TOTAL LENGTH:** The length from the point to the end of the drill bit

**POINT ANGLE:** The angle of the cutting edges

**DRILL DIAMETER:** The cutting diameter of the drill bit

**SHANK LENGTH:** The end of the drill bit that is secured by the drill

**WORKING LENGTH:** The length from the point to the end of the flutes

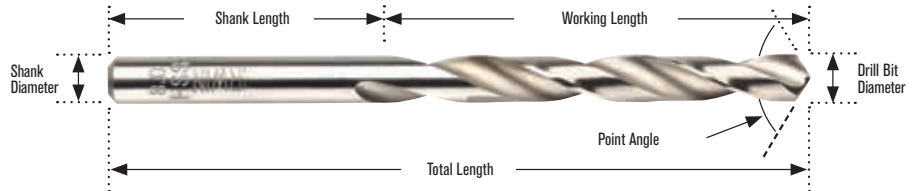

## TIP GEOMETRY

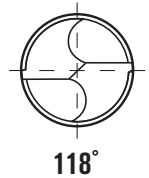

118°



### 118° STANDARD POINT

- For drilling in alloyed and non-alloyed steels, non-ferrous metals, cast iron and hard plastics
- Can be easily resharpened
- Requires higher feed pressure
- Best for stationary drills



118°



### 118° SPLIT POINT

- For drilling in alloyed and non-alloyed steels, non-ferrous metals, cast iron and hard plastics
- Very good centering
- Requires less effort / feed pressure



135°



### 135° SPLIT POINT

- For drilling in high strength steel and high-alloy steels
- Very good centering
- Requires less effort / feed pressure



### TURBOMAX® JET POINT

- Specially designed for portable drills
- Excellent centering, will not walk on any surface
- Precision-ground to stay sharp longer and drill faster

## HSS DRILL BITS



HSS TURBOMAX



HSS TITANIUM



HSS COBALT



HSS PRO

## SPECIALITY DRILL BITS



STEP DRILLS



TCT

## TURBOMAX™ HSS



**140° CUTTING SHOULDER FOR SMOOTH FINISH**

**100° TIP FOR FASTEST START**

**ROBUST REINFORCED WEB DESIGN**

**W9 HIGH SPEED STEEL (HSS)**

**HARDENING**

**GROUND FLUTE**

**3-FLATTED SHANK**

**DESIGNED FOR HIGH PERFORMANCE DRILLING**

Turbomax™ is designed primarily for high performance drilling in sheet metal, however, also performs well in all types of wood and plastic. Suitable for drilling stainless steel however, HSS Cobalt products (p.114) are designed specifically for this purpose. Remember to always use a coolant when drilling stainless steel.

- 1. 100° TIP FOR FASTEST START**  
Most precise centering and guidance  
No walking, including curved surfaces  
No centre punch necessary
- 2. 140° CUTTING SHOULDER FOR SMOOTH FINISH**  
Drills perfectly round holes with clean exit holes - minimised burrs  
Will not bind in multiple layers of thin material
- 3. GROUND FLUTE**  
Ground from solid for high accuracy drilling and fast removal of chips
- 4. ROBUST REINFORCED WEB DESIGN**  
For added strength and durability - no breakage
- 5. W9 HIGH SPEED STEEL (HSS)**  
For sharper cutting lips and superb heat resistance
- 6. HARDENING**  
Superb wear resistance. Hardness of 63-66 HRC
- 7. 3-FLATTED SHANK**  
Prevents slipping in chuck  
No damaging of the drill due to slipping  
Safe and strong clamping, especially when using keyless chucks

**JET POINT – REVOLUTIONARY TIP DESIGN**  
Self centering, will not walk on any surfaces



**JET POINT – REVOLUTIONARY TIP DESIGN**  
Self centering, will not walk on any surfaces

## TURBOMAX™ HSS DRILL BITS

ITEM NO.	DIAMETER mm	WORKING LENGTH mm	TOTAL LENGTH mm	PCS PER PACK	EAN	MASTER PACK	SHELF PACK
10502202	1.0	12	34	2	5709131232889	50	10
10502203	1.5	18	40	2	5709131232902	50	10
10502204	2.0	24	49	2	5709131232926	50	10
10502205	2.5	30	57	2	5709131232940	50	10
10502206	3.0	33	61	1	5709131232964	50	10
10502207	3.1	36	65	1	5709131232988	50	10
10502208	3.2	36	65	1	5709131233008	50	10
10502209	3.3	36	65	1	5709131233046	50	10
10502210	3.5	39	70	1	5709131233060	50	10
10502211	4.0	43	75	1	5709131233084	50	10
10502212	4.1	43	75	1	5709131233107	50	10
10502213	4.2	43	75	1	5709131233121	50	10
10502214	4.3	47	75	1	5709131233541	50	10
10502215	4.5	47	80	1	5709131233145	50	10
10502216	4.8	52	86	1	5709131233169	50	10
10502217	4.9	52	86	1	5709131233183	50	10
10502218	5.0	52	86	1	5709131233206	50	10
10502219	5.1	52	86	1	5709131233220	50	10
10502220	5.5	57	93	1	5709131233244	50	10
10502221	6.0	57	93	1	5709131233268	50	10
10502222	6.5	63	101	1	5709131233282	50	10
10502223	7.0	69	109	1	5709131233305	50	10
10502224	7.5	69	109	1	5709131233329	50	10
10502225	8.0	75	117	1	5709131233367	50	10
10502226	8.5	75	117	1	5709131233381	50	10
10502227	9.0	81	125	1	5709131233404	50	10
10502228	9.5	81	125	1	5709131233428	50	10
10502229	10.0	87	133	1	5709131233442	50	10
10502230	11.0	94	142	1	5709131233466	30	10
10502231	12.0	101	151	1	5709131233480	30	10
10502232	13.0	101	151	1	5709131233503	30	10



10502225





## HSS COBALT

135° SPLIT POINT GRINDING

INDUSTRIAL QUALITY GROUND FLUTE

COBALT ALLOYED DRILL BIT BODY

DESIGNED FOR DRILLING STAINLESS STEEL



GOLDEN TEMPERED SURFACE FINISH

- 1. 135° SPLIT POINT GRINDING**  
Ensures perfect centering and reduced drilling pressure
- 2. INDUSTRIAL QUALITY GROUND FLUTE**  
For high accuracy drilling and fast removal of chips
- 3. COBALT ALLOYED DRILL BIT BODY**  
Manufactured from high quality HSS steel containing 5% Cobalt (Co) – added 5% Cobalt improves the red hardness (heat resistance) and abrasion resistance of the drill bit and results in significantly extended life
- 4. GOLDEN TEMPERED SURFACE FINISH**  
For increased durability

### HSS COBALT DRILL BITS - DIN 338



ITEM NO.	DIAMETER mm	WORKING LENGTH mm	TOTAL LENGTH mm	PCS PER PACK	EAN	MASTER PACK	SHELF PACK
10502507	1.0	12	34	2	5709131282532	200	10
10502508	1.5	18	40	2	5709131282570	200	10
10502509	2.0	24	49	2	5709131282617	200	10
10502510	2.5	30	57	2	5709131282655	200	10
10502542	3.0	33	61	1	5709131282693	200	10
10502543	3.1	36	65	1	5709131282730	200	10
10502544	3.2	36	65	1	5709131282778	200	10
10502545	3.3	36	65	1	5709131282815	200	10
10502546	3.5	39	70	1	5709131282853	200	10
10502547	4.0	43	75	1	5709131282891	200	10
10502548	4.1	43	75	1	5709131282938	200	10
10502549	4.2	43	75	1	5709131282976	200	10
10502550	4.3	47	80	1	5709131283010	200	10
10502551	4.5	47	80	1	5709131283058	200	10
10502552	4.8	52	86	1	5709131283096	200	10
10502553	4.9	52	86	1	5709131283133	200	10
10502554	5.0	52	86	1	5709131283171	200	10
10502555	5.1	52	86	1	5709131283218	200	10
10502556	5.5	57	93	1	5709131283256	200	10
10502557	6.0	57	93	1	5709131283294	200	10
10502558	6.5	63	101	1	5709131283331	100	10
10502559	7.0	69	109	1	5709131283379	100	10
10502560	7.5	69	109	1	5709131283416	100	10
10502561	8.0	75	117	1	5709131283454	100	10
10502562	8.5	75	117	1	5709131283492	100	10
10502563	9.0	81	125	1	5709131283539	100	10
10502564	9.5	81	125	1	5709131283577	100	10
10502565	10.0	87	133	1	5709131283614	100	10
10502566	11.0	94	142	1	5709131283652	50	10
10502567	12.0	101	151	1	5709131283690	50	10
10502568	13.0	101	151	1	5709131283737	50	10

10502561

## HSS COBALT DRILL BITS - DIN 338 - BULK PACK

ITEM NO.	DIAMETER mm	WORKING LENGTH mm	TOTAL LENGTH mm	PCS PER PACK	EAN	MASTER PACK	SHELF PACK
10502511	1.0	12	34	10	5706915000450	50	1
10502512	1.5	18	40	10	5706915000474	50	1
10502513	2.0	24	49	10	5706915000498	50	1
10502514	2.5	30	57	10	5706915000511	50	1
10502515	3.0	33	61	10	5706915000535	50	1
10502516	3.1	36	65	10	5706915000559	50	1
10502517	3.2	36	65	10	5706915000573	50	1
10502518	3.3	36	65	10	5706915000597	50	1
10502519	3.5	39	70	10	5706915000610	50	1
10502520	4.0	43	75	10	5706915000634	50	1
10502521	4.1	43	75	10	5706915000658	50	1
10502522	4.2	43	75	10	5706915000672	50	1
10502523	4.3	47	80	10	5706915000696	50	1
10502524	4.5	47	80	10	5706915000719	50	1
10502525	4.8	52	86	10	5706915000733	50	1
10502526	4.9	52	86	10	5706915000757	50	1
10502527	5.0	52	86	10	5706915000771	50	1
10502528	5.1	52	86	10	5706915000795	50	1
10502529	5.5	57	93	10	5706915000818	20	1
10502530	6.0	57	93	10	5706915000832	50	1
10502531	6.5	63	101	10	5706915000856	20	1
10502532	7.0	69	109	10	5706915000894	20	1
10502533	7.5	69	109	5	5706915000870	40	1
10502534	8.0	75	117	5	5706915000917	40	1
10502535	8.5	75	117	5	5706915000931	40	1
10502536	9.0	81	125	5	5706915000955	40	1
10502537	9.5	81	125	5	5706915000979	40	1
10502538	10.0	87	133	5	5706915000993	40	1
10502539	11.0	94	142	5	5706915001013	20	1
10502540	12.0	101	151	5	5706915001037	20	1
10502541	13.0	101	151	5	5706915001051	20	1

**ALSO  
AVAILABLE  
IN SETS**  
SEE PAGE 136

## HSS TITANIUM



**135° SPLIT POINT GRINDING**

**TITANIUM NITRIDE (TiN) COATED HIGH QUALITY STEEL BODY**

**LESS HEAT TiN**

**INDUSTRIAL GROUND FLUTE**

**SPEED AND FEED**

**FAST AND PRECISE**

- 135° SPLIT POINT GRINDING**  
Ensures perfect centering and reduced drilling pressure
- INDUSTRIAL GROUND FLUTE**  
For high accuracy drilling and fast removal of chips
- TITANIUM NITRIDE (TiN) COATED HIGH QUALITY STEEL BODY**  
Resists heat and friction, providing up to six times longer life than standard metal drill bits\*  
The TiN coating has a hardness of app. 80 HRC and is very resistant to wear  
TiN has a low coefficient of friction. This results in less power being consumed and less heat generated during the drilling
- SPEED AND FEED**  
Compared to traditional HSS Twist Drill Bits, speed can be increased by 40 -60% and feed by 10 -20% without reducing the life time of the drill bit significantly
- LESS HEAT**  
TiN is also a poor conductor of heat, so the heat generated during the drilling process is diverted into the chips and coolant and less into the drill bit

\*Up to 6X longer bit life than black oxide coated bits



ITEM NO.	DIAMETER mm	WORKING LENGTH mm	TOTAL LENGTH mm	PCS PER PACK	EAN	MASTER PACK	SHELF PACK
10502572	1.0	12	34	2	5709131282556	200	10
10502573	1.5	18	40	2	5709131282594	200	10
10502574	2.0	24	49	2	5709131282631	200	10
10502575	2.5	30	57	2	5709131282679	200	10
10502576	3.0	33	61	1	5709131282716	200	10
10502577	3.1	36	65	1	5709131282754	200	10
10502578	3.2	36	65	1	5709131282792	200	10
10502579	3.3	36	65	1	5709131282839	200	10
10502580	3.5	39	70	1	5709131282877	200	10
10502581	4.0	43	75	1	5709131282914	200	10
10502582	4.1	43	75	1	5709131282952	200	10
10502583	4.2	43	75	1	5709131282990	200	10
10502584	4.3	47	80	1	5709131283034	200	10
10502585	4.5	47	80	1	5709131283072	200	10
10502586	4.8	52	86	1	5709131283119	200	10
10502587	4.9	52	86	1	5709131283157	200	10
10502588	5.0	52	86	1	5709131283195	200	10
10502589	5.1	52	86	1	5709131283232	200	10
10502590	5.5	57	93	1	5709131283270	200	10
10502591	6.0	57	93	1	5709131283317	200	10
10502592	6.5	63	101	1	5709131283355	100	10
10502593	7.0	69	109	1	5709131283393	100	10
10502594	7.5	69	109	1	5709131283430	100	10
10502595	8.0	75	117	1	5709131283478	100	10
10502596	8.5	75	117	1	5709131283515	100	10
10502597	9.0	81	125	1	5709131283553	100	10
10502598	9.5	81	125	1	5709131283591	100	10
10502599	10.0	87	133	1	5709131283638	100	10
10502600	11.0	94	142	1	5709131283676	50	10
10502601	12.0	101	151	1	5709131283713	50	10
10502602	13.0	101	151	1	5709131283751	50	10

**ALSO AVAILABLE IN SETS**  
SEE PAGE 136

10502595



## HSS PRO



HSS PRO is an industrial quality twist drill with outstanding performance and long service life. It is designed for drilling steel and steel castings, alloyed and non-alloyed steel, cast iron, non-ferrous metals, plastics and other materials. The 118° split point shape provides an optimum centering when starting and a faster drilling rate. It requires lower feed pressure than standard HSS drill bits with a chisel edge.

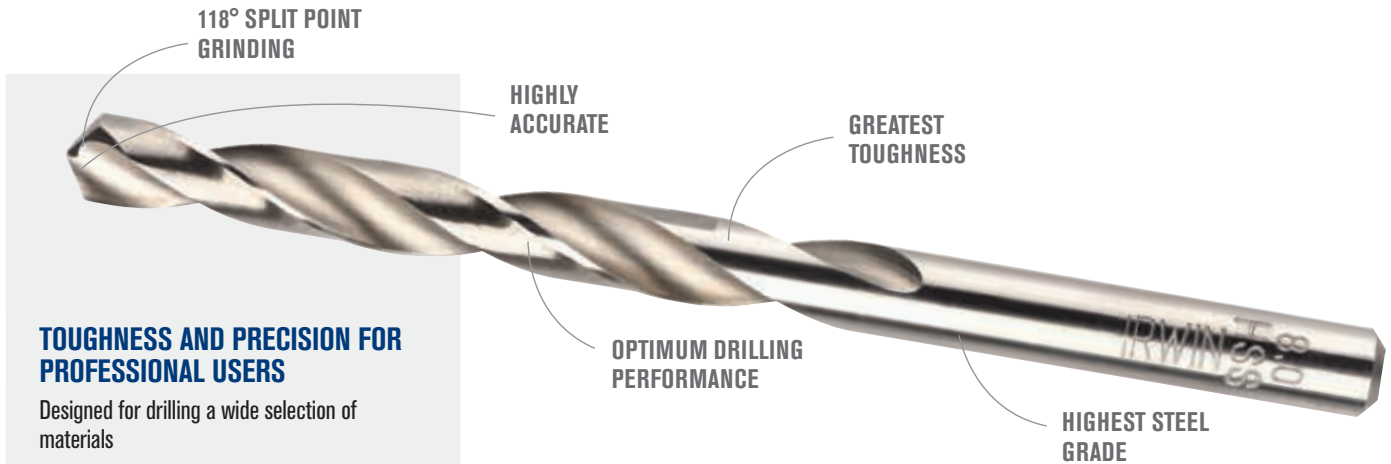

### TOUGHNESS AND PRECISION FOR PROFESSIONAL USERS

Designed for drilling a wide selection of materials



- 1. 118° SPLIT POINT SHAPE**  
With increased performance and very good centering  
Precision starting, no need to pre-punch or pilot drill  
Penetrates quickly  
Requires less effort / feed pressure
- 2. GREATEST TOUGHNESS**  
For low risk of breakage even when drilling with smaller diameters due to high elasticity
- 3. OPTIMUM DRILLING PERFORMANCE**  
Even in unfavourable working conditions
- 4. HIGHLY ACCURATE**  
Close tolerances and high concentricity for maximum precision
- 5. HIGHEST STEEL GRADE**  
High-performance, High-Speed Steel

**40%** MORE HOLES\*

\*vs previous version

### HSS PRO DRILL RANGE

The HSS PRO drill bits are available for a wide array of applications: DIN 338 jobber series, DIN 340 long series, double-ended stub series, DIN 345 Morse taper shank series.

DIN 338		DIN 338 series is suitable for many trade and industrial applications in alloyed and un-alloyed steel, non-ferrous metals, cast iron and plastics.
DIN 340		DIN 340 long series is most suitable for drilling deep holes or through hollow profiles.
Double-Ended		Double-ended series is especially designed for drilling thin materials like sheet metal, flat steel and profiles. Ideal for use with hand-held drills.
DIN 345		DIN 345 Morse taper shank series offers strong standard drill bits for use with stationary drilling machines. Designed for high breakage resistance.

## HSS PRO DRILL BITS - DIN 338



**MANUFACTURED TO DIN 338 STANDARDS** ideal for many trade and industrial applications  
**118° SPLIT POINT SHAPE** for increased performance and very good centering  
**SURFACE FINISH** Polished silver  
**PACKAGED** in skin card up to Ø 13 mm, in Quadro Pack from Ø 13.5 mm and above



**ALSO AVAILABLE IN SETS**  
SEE PAGE 137

10502393

ITEM NO.	DIAMETER mm	WORKING LENGTH mm	TOTAL LENGTH mm	PCS PER PACK	EAN	MASTER PACK	SHELF PACK
10502376	1.0	12	34	3	5709131104674	200	10
10502377	1.5	18	40	3	5709131104865	200	10
10502378	2.0	24	49	3	5709131105084	200	10
10502379	2.5	30	57	3	5709131105251	200	10
10502380	3.0	33	61	3	5709131105466	200	10
10502381	3.2	36	65	2	5709131105589	200	10
10502382	3.3	36	65	2	5709131105657	200	10
10502383	3.5	39	70	2	5709131105732	200	10
10502384	4.0	43	75	2	5709131105930	200	10
1863343	4.1	43	75	2	5706918633433	200	10
10502385	4.2	43	75	2	5709131106050	200	10
10502386	4.5	47	80	2	5709131106166	200	10
1863344	4.8	52	86	2	5706918633440	200	10
10502387	5.0	52	86	2	5709131106371	200	10
1863345	5.1	52	86	1	5706918633457	200	10
1863346	5.2	52	86	1	5706918633464	200	10
10502388	5.5	57	93	1	5709131106555	200	10
10502389	6.0	57	93	1	5709131106753	200	10
10502390	6.5	63	101	1	5709131106944	200	10
10502391	7.0	69	109	1	5709131107101	100	10
10502392	7.5	69	109	1	5709131107279	100	10
10502393	8.0	75	117	1	5709131107477	100	10
10502394	8.5	75	117	1	5709131107668	100	10
10502395	9.0	81	125	1	5709131107842	100	10
10502396	9.5	81	125	1	5709131108016	100	10
10502397	10.0	87	133	1	5709131108207	100	10

## HSS PRO DRILL BITS - REDUCED SHANK - DIN 338



ITEM NO.	DIAMETER mm	WORKING LENGTH mm	TOTAL LENGTH mm	PCS PER PACK	EAN	MASTER PACK	SHELF PACK
10502398	10.5	87	133	10mm	5709131108429	50	10
10502399	11.0	94	142	10mm	5709131108597	50	10
10502400	11.5	94	142	10mm	5709131108764	50	10
10502401	12.0	101	151	10mm	5709131108948	50	10
10502402	12.5	101	151	10mm	5709131109099	50	10
10502403	13.0	101	151	10mm	5709131109266	50	10
10502404	13.5	108	160	10mm	5709131109402	50	10
10502405	14.0	108	160	10mm	5709131109471	50	10
10502406	14.5	114	169	10mm	5709131109570	25	5
10502407	15.0	114	169	10mm	5709131109662	25	5
10502408	15.5	120	178	10mm	5709131109730	25	5
10502409	16.0	120	178	10mm	5709131109822	25	5
10502410	16.5	125	184	13mm	5709131109921	25	5
10502411	17.0	125	184	13mm	5709131109990	25	5
10502412	17.5	130	191	13mm	5709131110064	25	5
10502413	18.0	130	191	13mm	5709131110132	25	5
10502414	18.5	135	198	13mm	5709131110200	25	5
10502415	19.0	135	198	13mm	5709131110286	25	5
10502416	19.5	140	205	13mm	5709131110354	25	5
10502417	20.0	140	205	13mm	5709131110439	25	5

# METAL DRILLING

## HSS PRO DRILL BITS - DIN 338 - BULK PACK



ITEM NO.	DIAMETER mm	WORKING LENGTH mm	TOTAL LENGTH mm	PCS PER PACK	EAN	MASTER PACK	SHELF PACK
10502236	0.5	6	22	10	5709131035923	50	1
10502237	0.6	7	24	10	5709131035954	50	1
10502238	0.7	9	28	10	5709131035978	50	1
10502239	0.8	10	30	10	5709131035992	50	1
10502240	0.9	11	32	10	5709131036012	50	1
10502241	1.0	12	34	10	5709131036043	50	1
10502242	1.1	14	36	10	5709131036098	50	1
10502243	1.2	16	38	10	5709131036128	50	1
10502244	1.3	16	38	10	5709131036159	50	1
10502245	1.4	18	40	10	5709131036180	50	1
10502246	1.5	18	40	10	5709131036210	50	1
10502247	1.6	20	43	10	5709131036272	50	1
10502248	1.7	20	43	10	5709131036302	50	1
10502249	1.8	22	46	10	5709131036326	50	1
10502250	1.9	22	46	10	5709131036357	50	1
10502251	2.0	24	49	10	5709131036401	50	1
10502252	2.1	24	49	10	5709131036463	50	1
10502253	2.2	27	53	10	5709131036487	50	1
10502254	2.3	27	53	10	5709131036517	50	1
10502255	2.4	30	57	10	5709131036548	50	1
10502256	2.5	30	57	10	5709131036562	50	1
10502257	2.6	30	57	10	5709131036623	50	1
10502258	2.7	33	61	10	5709131036654	50	1
10502259	2.8	33	61	10	5709131036685	50	1
10502260	2.9	33	61	10	5709131036708	50	1
10502261	3.0	33	61	10	5709131036746	50	1
10502262	3.1	36	65	10	5709131036814	50	1
10502263	3.2	36	65	10	5709131036852	50	1
10502264	3.3	36	65	10	5709131036906	50	1
10502265	3.4	39	70	10	5709131036944	50	1
10502266	3.5	39	70	10	5709131036968	50	1
10502267	3.6	39	70	10	5709131037033	50	1
10502268	3.7	39	70	10	5709131037057	50	1
10502269	3.8	43	75	10	5709131037071	50	1
10502270	3.9	43	75	10	5709131037095	50	1
10502271	4.0	43	75	10	5709131231202	50	1
10502272	4.1	43	75	10	5709131037200	50	1
10502273	4.2	43	75	10	5709131037231	50	1
10502274	4.3	47	80	10	5709131037262	50	1
10502275	4.4	47	80	10	5709131037293	50	1
10502276	4.5	47	80	10	5709131037316	50	1
10502277	4.6	47	80	10	5709131037378	50	1
10502278	4.7	47	80	10	5709131037392	50	1
10502279	4.8	52	86	10	5709131037439	50	1
10502280	4.9	52	86	10	5709131037460	50	1
10502281	5.0	52	86	10	5709131037491	50	1
10502282	5.1	52	86	10	5709131037569	50	1
10502283	5.2	52	86	10	5709131037606	50	1
10502284	5.3	52	86	10	5709131037620	50	1
10502285	5.4	57	93	10	5709131037644	50	1
10502286	5.5	57	93	10	5709131037668	50	1
10502287	5.6	57	93	10	5709131037729	50	1
10502288	5.7	57	93	10	5709131037743	50	1
10502289	5.8	57	93	10	5709131037774	50	1
10502290	5.9	57	93	10	5709131037798	50	1
10502291	6.0	57	93	10	5709131037835	50	1
10502292	6.1	63	101	10	5709131037903	50	1
10502293	6.2	63	101	10	5709131037934	20	1
10502294	6.3	63	101	10	5709131037958	20	1
10502295	6.4	63	101	10	5709131037989	20	1
10502296	6.5	63	101	10	5709131038016	20	1
10502297	6.6	63	101	10	5709131038061	20	1



## HSS PRO DRILL BITS - DIN 338 - BULK PACK

10502311



ITEM NO.	DIAMETER mm	WORKING LENGTH mm	TOTAL LENGTH mm	PCS PER PACK	EAN	MASTER PACK	SHELF PACK
10502299	6.8	69	109	10	5709131038115	20	1
10502300	6.9	69	109	10	5709131038139	20	1
10502301	7.0	69	109	10	5709131038153	20	1
10502302	7.1	69	109	5	5709131038207	40	1
10502303	7.2	69	109	5	5709131038238	40	1
10502304	7.3	69	109	5	5709131038269	40	1
10502305	7.4	69	109	5	5709131038283	40	1
10502306	7.5	69	109	5	5709131038306	40	1
10502307	7.6	75	117	5	5709131038368	40	1
10502308	7.7	75	117	5	5709131038382	40	1
10502309	7.8	75	117	5	5709131038405	40	1
10502310	7.9	75	117	5	5709131038429	40	1
10502311	8.0	75	117	5	5709131038474	40	1
10502312	8.1	75	117	5	5709131038559	40	1
10502313	8.2	75	117	5	5709131038580	40	1
10502314	8.3	75	117	5	5709131038603	40	1
10502315	8.4	75	117	5	5709131038634	40	1
10502316	8.5	75	117	5	5709131038658	40	1
10502317	8.6	81	125	5	5709131038702	40	1
10502318	8.7	81	125	5	5709131038733	40	1
10502319	8.8	81	125	5	5709131038764	40	1
10502320	8.9	81	125	5	5709131038788	40	1
10502321	9.0	81	125	5	5709131038818	40	1
10502322	9.1	81	125	5	5709131038863	40	1
10502323	9.2	81	125	5	5709131038894	40	1
10502324	9.3	81	125	5	5709131038917	40	1
10502325	9.4	81	125	5	5709131038931	40	1
10502326	9.5	81	125	5	5709131038962	40	1
10502327	9.6	87	133	5	5709131039020	40	1
10502328	9.7	87	133	5	5709131039051	40	1
10502329	9.8	87	133	5	5709131039075	40	1
10502330	9.9	87	133	5	5709131039099	40	1
10502331	10.0	87	133	5	5709131039129	40	1
10502332	10.1	87	133	5	5709131184638	20	1
10502333	10.2	87	133	5	5709131039211	20	1
10502334	10.3	87	133	5	5709131039242	20	1
10502335	10.4	87	133	5	5709131039273	20	1
10502336	10.5	87	133	5	5709131039297	20	1
10502337	10.6	87	133	5	5709131039365	20	1
10502338	10.7	94	142	5	5709131039389	20	1
10502339	10.8	94	142	5	5709131163114	20	1
10502340	10.9	94	142	5	5709131039419	20	1
10502341	11.0	94	142	5	5709131039433	20	1
10502342	11.1	94	142	5	5709131039501	20	1
10502343	11.2	94	142	5	5709131039525	20	1
10502344	11.3	94	142	5	5709131039549	20	1
10502345	11.4	94	142	5	5709131039563	20	1
10502346	11.5	94	142	5	5709131039587	20	1
10502348	11.7	94	142	5	5709131039679	20	1
10502349	11.8	94	142	5	5709131039686	20	1
10502350	11.9	101	151	5	5709131039709	20	1
10502351	12.0	101	151	5	5709131039723	20	1
10502352	12.1	101	151	5	5709131039792	20	1
10502353	12.2	101	151	5	5709131039822	20	1
10502355	12.4	101	151	5	5709131039853	20	1
10502356	12.5	101	151	5	5709131039877	20	1
10502357	12.6	101	151	5	5709131039921	20	1
10502358	12.7	101	151	5	5709131039945	20	1
10502360	12.9	101	151	5	5709131039990	20	1
10502361	13.0	101	151	5	5709131040002	20	1
10502362	13.5	108	160	5	5709131281085	20	1
10502363	14.0	108	160	1	5709131040163	25	1
10502364	14.5	114	169	1	5709131040200	25	1
10502365	15.0	114	169	1	5709131040262	25	1
10502366	15.5	120	178	1	5709131040316	25	1

## HSS PRO DRILL BITS - DIN 338 - BULK PACK



ITEM NO.	DIAMETER mm	WORKING LENGTH mm	TOTAL LENGTH mm	PCS PER PACK	EAN	MASTER PACK	SHELF PACK
10502367	16.0	120	178	1	5709131040354	25	1
10502368	16.5	125	184	1	5709131040408	25	1
10502369	17.0	125	184	1	5709131040460	25	1
10502370	17.5	130	191	1	5709131040507	25	1
10502371	18.0	130	191	1	5709131040545	25	1
10502372	18.5	135	198	1	5709131040583	25	1
10502373	19.0	135	198	1	5709131040620	25	1
10502374	19.5	140	205	1	5709131040675	25	1
10502375	20.0	140	205	1	5709131040712	25	1

## HSS PRO LONG DRILL BITS - DIN 340



ITEM NO.	DIAMETER mm	WORKING LENGTH mm	TOTAL LENGTH mm	PCS PER PACK	EAN	MASTER PACK	SHELF PACK
1863347	3.0	70	110	1	5706918633471	200	10
1863348	4.0	80	120	1	5706918633488	200	10
1863349	5.0	90	135	1	5706918633495	200	10
1863350	6.0	95	140	1	5706918633501	200	10
1863361	8.0	105	160	1	5706918633617	100	10
1863362	10.0	115	175	1	5706918633624	100	10

**MANUFACTURED TO DIN 340 STANDARDS** for drilling deep holes or through hollow profiles  
**118° SPLIT POINT SHAPE** for increased performance and very good centering  
**SURFACE FINISH** is polished silver  
**PACKAGED** in skin card

## HSS PRO LONG DRILL BITS - DIN 340 - BULK PACK

ITEM NO.	DIAMETER mm	WORKING LENGTH mm	TOTAL LENGTH mm	PCS PER PACK	EAN	MASTER PACK	SHELF PACK
10502482	2.0	55	85	10	5709131061755	20	1
10502483	2.5	65	100	10	5709131041931	20	1
10502484	3.0	70	110	10	5709131041948	20	1
10503855	3.2	70	110	10	5706915938555	20	1
10502485	3.5	80	120	10	5709131041955	20	1
10502486	4.0	80	120	10	5709131041962	20	1
10503856	4.2	80	120	10	5706915938562	20	1
10502487	4.5	85	130	10	5709131041986	20	1
10504418	4.8	87	132	10	5706915944181	20	1
10502488	5.0	90	135	10	5709131041993	20	1
10504420	5.2	91	139	10	5706915944204	20	1
10502489	5.5	95	140	10	5709131042013	20	1
10502490	6.0	95	140	10	5709131042020	20	1
10502491	6.5	100	150	10	5709131111856	20	1
10502492	7.0	100	150	10	5709131042037	20	1
10502493	7.5	105	160	5	5709131061762	20	1
10502494	8.0	105	160	5	5709131042044	20	1
10502495	8.5	105	160	5	5709131111900	20	1
10502496	9.0	110	170	5	5709131061786	20	1
10502497	9.5	115	175	5	5709131061793	20	1
10502498	10.0	115	175	5	5709131042051	20	1
10503858	12.0	134	205	5	5706915938586	20	1

## HSS PRO DOUBLE-ENDED DRILL BITS - BULK PACK



ITEM NO.	DIAMETER mm	WORKING LENGTH mm	TOTAL LENGTH mm	PCS PER PACK	EAN	MASTER PACK	SHELF PACK
1868262	3.0	11	46	10	5706918682622	50	1
1868263	3.1	12	49	10	5706918682639	50	1
1868264	3.2	12	49	10	5706918682646	50	1
10502479	3.3	12	49	10	5709131041559	50	1
1868265	3.5	14	52	10	5706918682653	50	1
1868266	4.0	14	56	10	5706918682660	50	1
10502480	4.1	14	56	10	5709131041634	50	1
1868267	4.2	14	56	10	5706918682677	50	1
10502481	4.5	18	62	10	5709131041702	50	1

**118° SPLIT POINT SHAPE** for increased performance and very good centering  
**PARTICULARLY SUITED** for drilling thin materials, especially for car body work and tubular rivet holes  
**DOUBLE LIFETIME** versus a single end drill bit  
**ADAPTED DIAMETERS** for most common blind rivets  
**SURFACE FINISH** is polished silver  
**PACKAGED** in Quadro Pack

## HSS PRO DRILL BITS - DIN 345 - TAPER SHANK



ITEM NO.	DIAMETER mm	WORKING LENGTH mm	TOTAL LENGTH mm	PCS PER PACK	SHANK SIZE	EAN	PACK	SHELF PACK
10502418	10.0	87	168	5	MK 1	5709131039181	10	1
10502419	10.5	87	168	5	MK 1	5709131039327	10	1
10502420	11.0	94	175	5	MK 1	5709131039464	10	1
10502422	12.0	101	182	5	MK 1	5709131039754	10	1
10502424	13.0	101	182	5	MK 1	5709131040026	10	1
10502425	13.5	108	189	5	MK 1	5709131040132	10	1
10502426	14.0	108	189	1	MK 1	5709131040170	25	1
10502427	14.5	114	212	1	MK 2	5709131040231	25	1
10502428	15.0	114	212	1	MK 2	5709131040286	25	1
10502429	15.5	120	218	1	MK 2	5709131040323	25	1
10502430	16.0	120	218	1	MK 2	5709131040378	25	1
10502431	16.5	125	223	1	MK 2	5709131040439	25	1
10502432	17.0	125	223	1	MK 2	5709131040477	25	1
10502433	17.5	130	228	1	MK 2	5709131040514	25	1
10502434	18.0	130	228	1	MK 2	5709131040552	25	1
10502435	18.5	135	233	1	MK 2	5709131040590	25	1
10502436	19.0	135	233	1	MK 2	5709131040637	25	1
10502437	19.5	140	238	1	MK 2	5709131040682	25	1
10502438	20.0	140	238	1	MK 2	5709131040729	25	1
10502439	20.5	145	243	1	MK 2	5709131040767	25	1
10502440	21.0	145	243	1	MK 2	5709131040781	25	1
10502441	21.5	150	248	1	MK 2	5709131040804	25	1
10502442	22.0	150	248	1	MK 2	5709131040828	25	1
10502443	22.5	155	253	1	MK 2	5709131040859	25	1
10502444	23.0	155	253	1	MK 2	5709131040873	25	1
10502445	23.5	160	261	1	MK 3	5709131040903	25	1
10502446	24.0	160	261	1	MK 3	5709131040910	25	1
10502447	24.5	160	261	1	MK 3	5709131040927	25	1
10502448	25.0	160	261	1	MK 3	5709131040934	25	1
10502450	26.0	165	286	1	MK 3	5709131040965	25	1
10502451	26.5	165	286	1	MK 3	5709131040972	10	1
10502452	27.0	170	291	1	MK 3	5709131040989	10	1
10502453	27.5	170	291	1	MK 3	5709131040996	10	1
10502454	28.0	170	291	1	MK 3	5709131041009	10	1
10502456	29.0	175	296	1	MK 3	5709131041023	10	1
10502458	30.0	175	296	1	MK 3	5709131041054	10	1
10502460	31.0	180	301	1	MK 3	5709131041078	10	1
10502461	31.5	180	301	1	MK 3	5709131041092	10	1
10502462	32.0	185	334	1	MK 4	5709131041115	10	1
10502464	33.0	185	334	1	MK 4	5709131041139	5	1
10502466	34.0	190	339	1	MK 4	5709131041153	5	1
10502468	35.0	190	339	1	MK 4	5709131041177	5	1
10502470	36.0	195	344	1	MK 4	5709131041207	5	1
10502474	38.0	200	349	1	MK 4	5709131041245	5	1
10502478	40.0	200	349	1	MK 4	5709131041283	5	1

**MANUFACTURED TO DIN 345 STANDARDS** for use with stationary drilling machines  
**118° CHISEL POINT SHAPE** for maximum service life  
**MORSE TAPER SHANK DESIGN** for high breakage resistance  
**SURFACE FINISH** is black oxide coating for added corrosion resistance  
**PACKAGED** in Quadro Pack



10502434





## STEP DRILLS

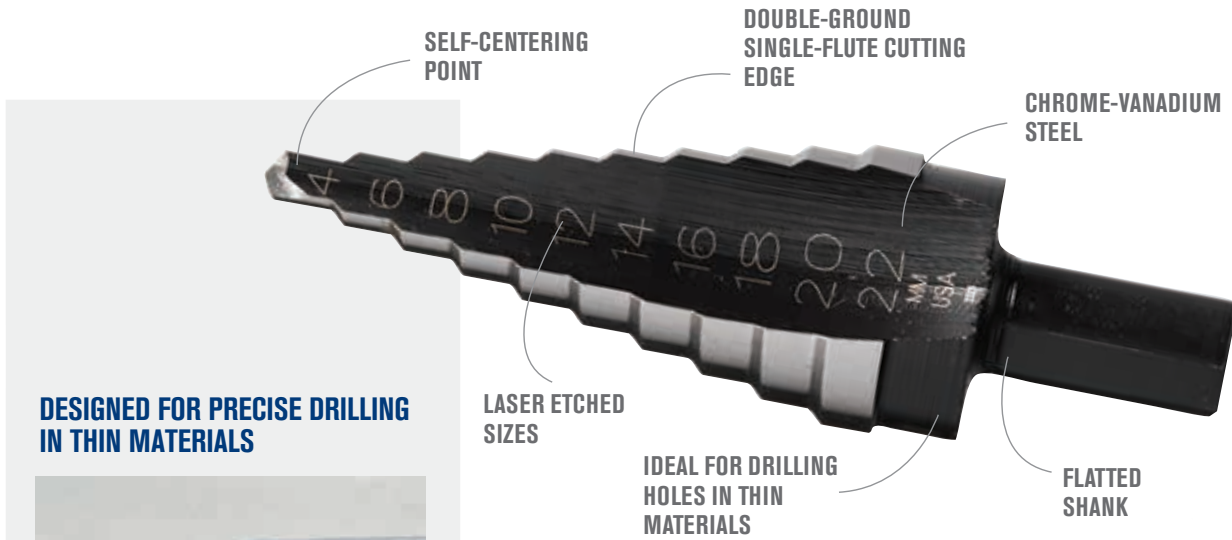

**DESIGNED FOR PRECISE DRILLING IN THIN MATERIALS**

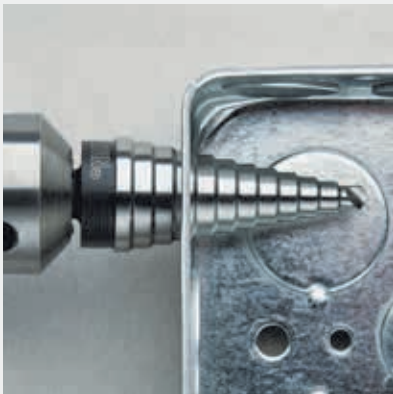

1. **SELF CENTERING POINT**  
Will not walk and eliminates the need for centre punching.
2. **CHROME-VANADIUM STEEL**  
Drill bit body is hardened to 56 HRC for durability.
3. **DOUBLE-GROUND SINGLE-FLUTE CUTTING EDGE**  
For extra chip capacity, drilling of true, round holes and provides maximum step control.
4. **IDEAL FOR DRILLING HOLES IN THIN MATERIALS**  
Including mild steel, copper, brass, aluminium, plexiglass, plastic, wood and laminates.
5. **FLATTED SHANK**  
Prevents the drill bit from slipping in the chuck.
6. **LASER ETCHED SIZES**  
Inside flute for easy and permanent hole size identification.

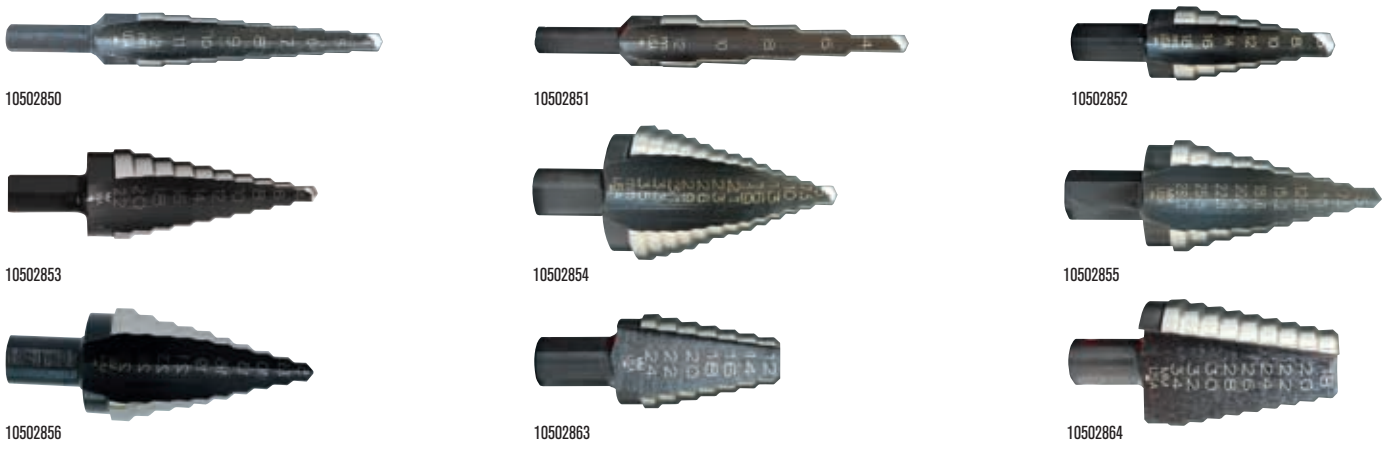

ITEM NO.	DESCRIPTION	EAN	MASTER PACK	SHELF PACK
10502850	1M 9 Hole sizes (4mm - 12mm), 1mm increments	38548111018	5	1
10502851	2M 5 Hole sizes (4mm - 12mm), 2mm increments	38548111025	5	1
10502852	3M 7 Hole sizes (6mm - 18mm), 2mm increments	38548111032	5	1
10502853	4M 10 Hole sizes (4mm - 22mm), 2mm increments	38548111049	5	1
10502854	5M 13 Hole sizes (5mm - 35mm), 2 - 3mm increments	38548111056	5	1
10502855	PG29M10 Hole sizes 5, 7.5, 10, 12.5, 15.2, 18.6, 20.4, 22.5, 25.5, 28.3mm	38548111940	5	1
10502856	29MM 10 Hole sizes 5, 7.5, 10, 13, 16, 19, 21, 23, 26, 29mm	38548111957	5	1
10502857	ISO/PG13 Hole sizes 5, 7.5, 9.7, 12.7, 15.2, 16.2, 18.6, 20.4, 22.5, 25.4, 28.3, 30.5, 32.5mm	38548111967	5	1
10502863	20M 6 Hole sizes (14 - 24mm)	38548112206	5	1
10502864	21M 8 Hole sizes (20 - 34mm)	38548112213	5	1



## TCT DRILL BITS

Designed for drilling hard and abrasive materials



### HSS PRO DRILL BITS - DIN 338

	ITEM NO.	DIAMETER mm	WORKING LENGTH mm	TOTAL LENGTH mm	EAN	MASTER PACK	SHELF PACK
<b>FOUR FACETED GROUND CARBIDE TIP</b> for low drilling pressure and perfect centering <b>EXTRA DEEP GROUND DOUBLE FLUTES</b> for extra chip capacity <b>REDUCED FLUTE</b> for body clearance and less friction <b>CHROME-VANADIUM STEEL BODY</b> is hardened to 56 HRC for durability. <b>ALWAYS USE COOLANT</b> when drilling with TCT Twist Drill Bits to extend the life time of the drill bit. It is recommended to use a 3-6% emulsion.	10502618	2.0	24	51	5709131042235	50	10
	10502619	2.5	30	57	5709131042372	50	10
	10502620	3.0	33	61	5709131042549	50	10
	10502621	3.1	39	70	5709131042570	50	10
	10502622	3.2	39	70	5709131042617	50	10
	10502624	3.3	39	70	5709131042662	50	10
	10502626	3.5	39	70	5709131042723	50	10
	10502627	3.6	43	75	5709131042761	50	10
	10502631	4.0	43	75	5709131042907	50	10
	10502633	4.2	47	80	5709131042976	50	10
	10502634	4.3	47	80	5709131043010	50	10
	10502636	4.5	47	80	5709131043089	50	10
	10502641	5.0	52	86	5709131043270	50	10
	10502642	5.1	57	93	5709131043324	50	10
	10502643	5.2	57	93	5709131043362	50	10
	10502644	5.3	57	93	5709131043409	50	10
	10502646	5.5	57	93	5709131043461	50	10
10502649	5.8	57	93	5709131043577	50	10	
10502651	6.0	57	93	5709131043645	50	10	
10502656	6.5	63	101	5709131043829	50	10	
10502658	6.7	69	109	5709131043881	50	10	
10502659	6.8	69	109	5709131043935	50	10	
10502661	7.0	69	109	5709131043980	50	10	
10502662	7.1	69	109	5709131044017	50	10	
10502666	7.5	69	109	5709131044147	50	10	
10502671	8.0	75	117	5709131044307	50	10	
10502676	8.5	75	117	5709131044475	50	10	
10502680	9.0	81	125	5709131044659	50	10	
10502685	9.5	81	125	5709131044772	50	10	
10502689	10.0	87	133	5709131044949	50	10	
10502690	10.5	87	133	5709131045137	30	10	
10502691	11.0	94	142	5709131045274	30	10	
10502692	11.5	94	142	5709131045397	30	10	
10502693	12.0	101	151	5709131045564	30	10	
10502694	12.5	101	151	5709131045700	30	10	
10502695	13.0	101	151	5709131045847	30	10	
10502696	13.5	108	160	5709131045892	30	10	
10502697	14.0	108	160	5709131045922	30	10	
10502699	15.0	114	169	5709131045991	15	10	
10502701	16.0	120	178	5709131046097	15	5	



10502671

# WOOD DRILLING





### IRWIN®

In 1885, Charles Irwin patented the Auger bit and, along with four business partners, formed the IRWIN® Auger Bit Company in Ohio, USA. Over 125 years later, IRWIN® is still the leading manufacturer of wood drilling bits and accessories. No matter what wood drilling project you face, IRWIN® Tools makes a drill bit that performs the job better. Our mark of quality is stamped right on the shank of our full range of bits. Whether the job requires quick, clean holes, or precise finish work, IRWIN® has a bit for every application and every need.

Professionals can now improve their productivity and accuracy with IRWIN®'s innovative ranges. IRWIN® Blue Groove 4X and Blue Groove 6X wood boring bits raise-the-bar on tool quality and performance. The cutting edge technology incorporates true "cutting edges" that glide through the wood versus scraping its way through. The latest generation Blue Groove Power is adding extreme durability thanks to Bi-Metal Technology.



#### TRI-FLUTE & FLAT BITS



BLUE GROOVE POWER



BLUE GROOVE 6X



BLUE GROOVE 4X

#### TRADITIONAL BITS



AUGER



BRAD POINT

#### EXTENSIONS



QUICK-CHANGE EXTENSIONS



STANDARD EXTENSIONS

## BLUE GROOVE POWER WOOD BORING BITS

**BLUE GROOVE POWER**

**FULL SCREW TIP**

**COMPACT LENGTH**

**IRWIN 25mm**

**TAPERED TRI-FLUTE DESIGN**

**EXTREME DURABILITY**

**QUICK-CHANGE SHANK**

**TOUGHER THAN NAILS**

**THE LONGEST LASTING WOOD BORING BIT**

**6x**

\*Up to 6 times faster than competitor products

**x50 LIFE**

\* Up to 50 times more durable than competitor products.

Quick Change Shank

Nail-Embedded Wood

- 1. EXTREME DURABILITY**  
HSS tip manufactured with Bi-Metal technology cutting edges provide long life in tough applications including nail-embedded wood
- 2. FULL SCREW TIP**  
For easy pull through and added accuracy
- 3. TAPERED TRI-FLUTE DESIGN**  
For faster chip ejection, less binding and ease of use
- 4. COMPACT LENGTH**  
Designed to fit between studs in most common applications
- 5. QUICK-CHANGE SHANK**  
1/4" Quick-Change shank on 14-16mm bits and 3/8" Quick-Change shank on 18-32mm bits

LONG-LASTING

ITEM NO.	DESCRIPTION	EAN	MASTER PACK	SHELF PACK
10507712	BlueGroove Power 14mm	5706915077124	36	1
10507713	BlueGroove Power 16mm	5706915077131	36	1
10507714	BlueGroove Power 18mm	5706915077148	36	1
10507715	BlueGroove Power 20mm	5706915077155	36	1
10507716	BlueGroove Power 22mm	5706915077162	36	1
10507717	BlueGroove Power 25mm	5706915077179	36	1
10507718	BlueGroove Power 28mm	5706915077186	36	1
10507719	BlueGroove Power 32mm	5706915077193	36	1

**ALSO AVAILABLE IN SETS**  
SEE PAGE 137



10507713

# BLUE GROOVE 6X WOOD BORING BITS

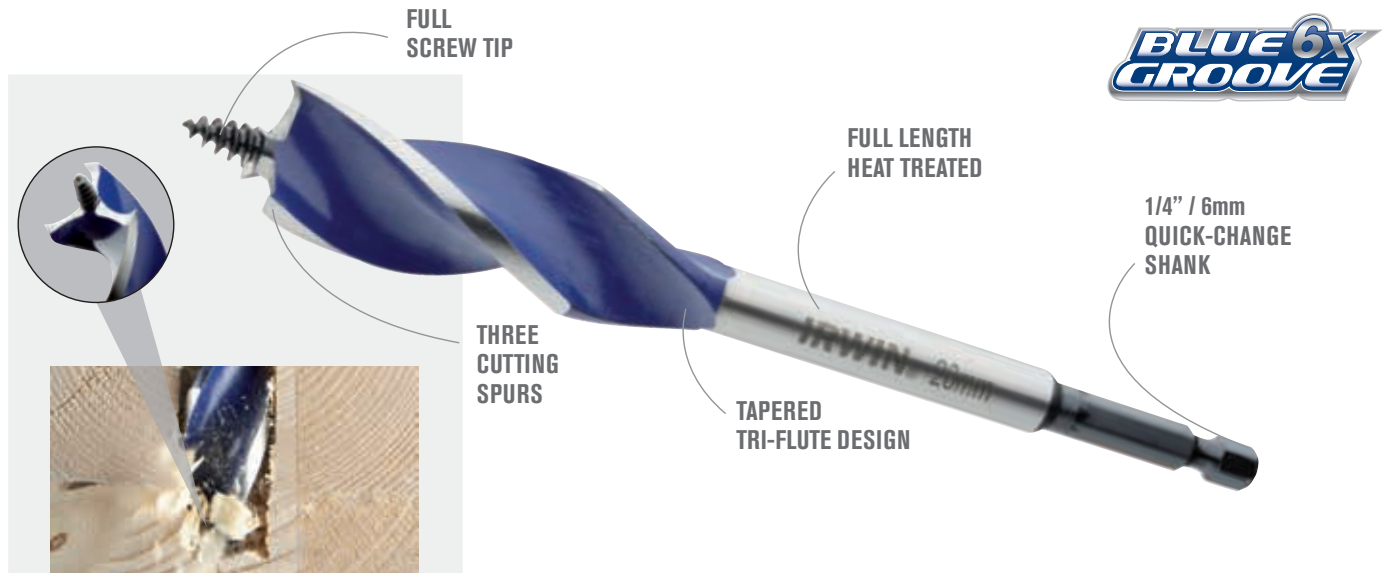

**6 TIMES FASTER THAN STANDARD FLAT BITS**



\*Up to 6 times faster than competitor products



Quick Change Shank



Saves Battery Life



Wood

- 1. THREE CUTTING SPURS**  
For clean holes with minimal break out
- 2. FULL SCREW TIP**  
For easy pull through and added accuracy
- 3. TAPERED TRI-FLUTE DESIGN**  
For faster chip ejection, less binding and ease of use
- 4. FULL LENGTH HEAT TREATED**  
For extra durability
- 5. 1/4" / 6mm QUICK-CHANGE SHANK**  
Reduces slipping in standard chucks and is compatible with 1/4" / 6mm quick-change chucks
- 6. MULTIPLE LENGTHS AVAILABLE - 4", 6" & 16"**  
Short Length Bits for for drilling in tight spaces. Ideal for holes up to 2" (50mm) deep  
Standard length bits ideal for holes up to 4" (100mm) deep  
Extended length bits include hole in flute for easy wire pulling through walls, ceilings and floors

**ALSO AVAILABLE IN SETS**  
SEE PAGE 138



ITEM NO.	DESCRIPTION	EAN	MASTER PACK	SHELF PACK
<b>SHORT LENGTH BITS - 4" / 100mm</b>				
1921930	Blue Groove 6X 14mm x 4" Clam	5706919219308	36	3
1921991	Blue Groove 6X 16mm x 4" Clam	5706919219919	36	3
1921992	Blue Groove 6X 18mm x 4" Clam	5706919219926	36	3
1921993	Blue Groove 6X 20mm x 4" Clam	5706919219933	36	3
1921994	Blue Groove 6X 22mm x 4" Clam	5706919219940	36	3
1921995	Blue Groove 6X 25mm x 4" Clam	5706919219957	36	3
1921996	Blue Groove 6X 28mm x 4" Clam	5706919219964	36	3
1921997	Blue Groove 6X 32mm x 4" Clam	5706919219971	36	3
<b>STANDARD LENGTH BITS - 6" / 165mm</b>				
10507602	Blue Groove 6X 14mm x 6" Clam	5706915076028	36	6
10506620	Blue Groove 6X 16mm x 6" Clam	5706915066203	36	6
10506621	Blue Groove 6X 18mm x 6" Clam	5706915066210	36	6
10506622	Blue Groove 6X 20mm x 6" Clam	5706915066227	36	6
10506623	Blue Groove 6X 22mm x 6" Clam	5706915066234	36	6
10506624	Blue Groove 6X 25mm x 6" Clam	5706915066241	36	6
10506625	Blue Groove 6X 28mm x 6" Clam	5706915066258	36	6
10506626	Blue Groove 6X 32mm x 6" Clam	5706915066265	36	6
<b>EXTENDED LENGTH BITS - 16" / 400mm</b>				
1921998	Blue Groove 6X 14mm x 16" Clam	5706919219988	36	3
1921999	Blue Groove 6X 16mm x 16" Clam	5706919219995	36	3
1922000	Blue Groove 6X 18mm x 16" Clam	5706919220007	36	3
1922001	Blue Groove 6X 20mm x 16" Clam	5706919220014	36	3
1922002	Blue Groove 6X 22mm x 16" Clam	5706919220021	36	3
1922003	Blue Groove 6X 25mm x 16" Clam	5706919220038	36	3
1922004	Blue Groove 6X 28mm x 16" Clam	5706919220045	36	3
1922005	Blue Groove 6X 32mm x 16" Clam	5706919220052	36	3



## BLUE GROOVE 4X FLAT BITS

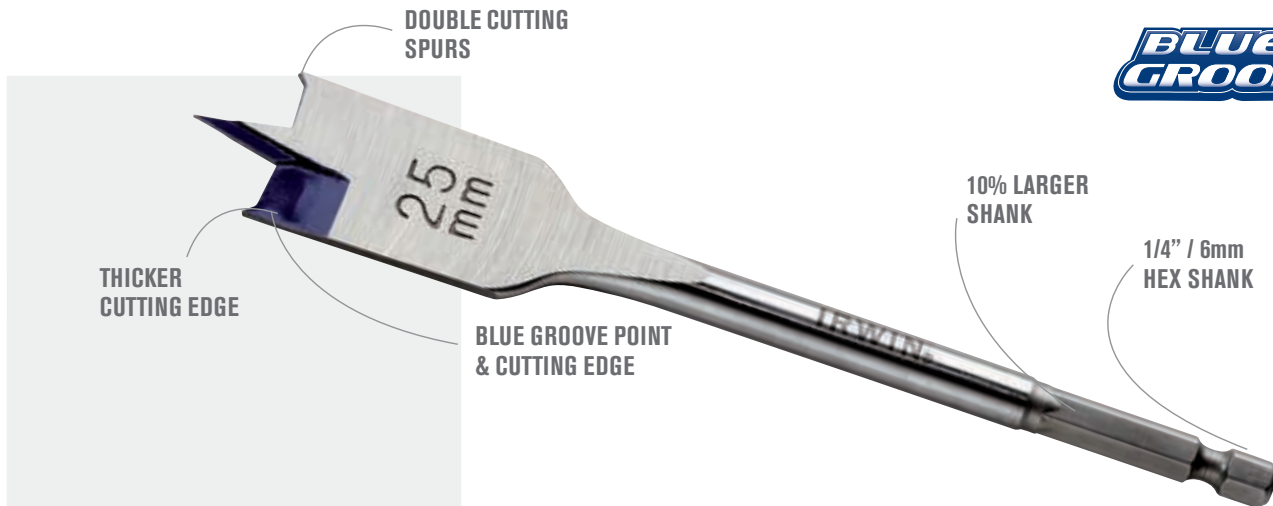

**4 TIMES FASTER THAN STANDARD FLAT BITS**



\*Up to 4 times faster versus basic flat bits



Quick Change Shank



Saves Battery Life



Wood

- 1. DOUBLE CUTTING SPURS**  
Scribe outside of the hole, reducing breakout
- 2. THICKER CUTTING EDGE**  
For longer drilling life
- 3. BLUE GROOVE POINT & CUTTING EDGE**  
For faster chip removal

- 4. 10% LARGER SHANK**  
For added durability
- 5. 1/4" / 6mm HEX SHANK**  
Prevents bit slipping in chuck

### BLUE GROOVE 4X FLAT BITS - LENGTH 152mm

ITEM NO.	DESCRIPTION	EAN	MASTER PACK	SHELF PACK
10502803	6mm	0024721013811	36	6
10502804	8mm	0024721013828	36	6
10502805	10mm	0024721013835	36	6
10502806	12mm	0024721013842	36	6
10502807	13mm	0024721013859	36	6
10502808	14mm	0024721013866	36	6
10502809	16mm	0024721013873	36	6
10502810	17mm	0024721889171	36	6
10502811	18mm	0024721013880	36	6
10502812	19mm	0024721013897	36	6
10502813	20mm	0024721013903	36	6
10502814	22mm	0024721013910	36	6
10502815	24mm	0024721013934	36	6
10502816	25mm	0024721013941	36	6
10502817	26mm	0024721013958	36	6
10502818	28mm	0024721013965	36	3
10502819	30mm	0024721013972	36	3
10502820	32mm	0024721013989	36	3
10502821	35mm	0024721014009	36	3
10502822	38mm	0024721014016	36	3
10502823	40mm	0024721889409	36	3



**ALSO AVAILABLE IN SETS**  
SEE PAGE 138

10502813

### BLUE GROOVE 4X FLAT BITS - LENGTH 400mm



LONGER LENGTH for extended reach NOT FOR USE with bit extensions or drill presses	ITEM NO.	DESCRIPTION	EAN	MASTER PACK	SHELF PACK
	10502830	6mm	0024721886064	36	6
10502831	8mm	0024721886088	36	6	
10502832	10mm	0024721013064	36	6	
10502833	12mm	0024721014153	36	6	
10502834	13mm	0024721014184	36	6	
10502835	14mm	0024721013071	36	6	
10502836	16mm	0024721014191	36	6	
10502837	18mm	0024721014207	36	6	
10502838	19mm	0024721013088	36	6	
10502839	20mm	0024721014214	36	6	
10502840	22mm	0024721014221	36	6	
10502842	25mm	0024721014245	36	6	
10502843	28mm	0024721014269	18	3	
10502844	30mm	0024721014276	18	3	
10502845	32mm	0024721014283	18	3	
10502846	35mm	0024721014290	18	3	

## BRAD POINT



### SOLID CENTRE AUGER WITH CUTTING SPUR



BRAD POINT TIP provides accurate positioning for starting the hole BIT IS PRECISION GROUND for use in furniture making, doweling, cabinetry and other woodworking applications where an exact hole size is required SPUR CUTTING EDGES reduce splintering and ensure a smooth, clean hole WIDE FLUTES provide a fast, continuous flow of chips	ITEM NO.	DIAMETER mm	WORKING LENGTH mm	TOTAL LENGTH mm	EAN	MASTER PACK	SHELF PACK
	10502792	3.0	37	67	5709131134534	200	10
10502793	4.0	52	88	5709131134558	200	10	
10502794	5.0	59	95	5709131134572	200	10	
10502795	6.0	67	103	5709131134596	200	10	
10502796	8.0	78	119	5709131134619	200	10	
10502797	10.0	87	136	5709131134633	200	10	
10502798	12.0	100	145	5709131134657	100	10	
10502799	13.0	104	149	5709131134671	100	10	
10502800	16.0	130	178	5709131134695	25	5	

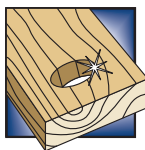

Perfect for all types of wood  
Creates perfect and straight holes

## LOCK-N-LOAD™ QUICK-CHANGE EXTENSIONS

6 TIMES FASTER THAN STANDARD FLAT BITS



### LOCK-N-LOAD™ COMPATIBILITY

6,3 mm ( 1/4" )	
	ALL POWER BITS
	ALL INSERT BITS
	ALL BLUE GROOVE 4X
	ALL BLUE GROOVE 6X
	BLUE GROOVE POWER 14 - 16mm
	STEP DRILLS 1M - 2M

LOCK-N-LOAD™ SYSTEM for one-handed quick release  
**JAW DESIGN** holds bits securely on 6-flatted shanks, as well as ball detent bits  
**1/4" QUICK CHANGE RANGE** now holds insert bits  
**CARBON STEEL CONSTRUCTION SLEEVE AND BODY** for durability and life  
**LOCK-N-LOAD™ COMPATIBILITY**



9,5 mm ( 3/8" )	
	STEP DRILLS (SIZE 3M - 4M)
	HOLE SAW ARBORS 9.5mm
	BLUE GROOVE POWER 18 - 32mm

ITEM NO.	DESCRIPTION	EAN	MASTER PACK	SHELF PACK
10508166	1/4" Quick Change Bit Holder - 2,5" / 65 mm	5706915081664	48	6
10508167	1/4" Quick Change Bit Holder - 6" / 150 mm	5706915081671	48	6
10508168	1/4" Quick Change Bit Holder - 12" / 300 mm	5706915081688	48	6
10508170	3/8" Quick Change Bit Holder - 5,5" / 140 mm	5706915081701	24	3
10508171	3/8" Quick Change Bit Holder - 12" / 300 mm	5706915081717	24	3



10508167



## AUGER

SOLID CENTRE AUGER WITH CUTTING SPUR



The Original  
**AUGER**

### AUGER DRILL BITS

**COARSE SCREW POINT** for faster drilling into all types of wood  
**SINGLE SPUR DESIGN** for smoother hole finish  
**EXTRA WIDE FLUTE** for faster chip removal  
**FULLY HARDENED BODY** from tip to shank for extra durability  
**HEX SHANK** prevents bit slipping in chuck

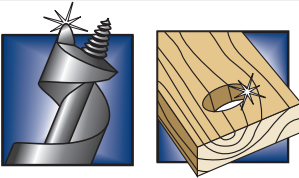

Perfect for all types of wood  
 Creates perfect and straight holes



10502761

ITEM NO.	DIAMETER mm	WORKING LENGTH mm	TOTAL LENGTH mm	HEX FACES mm	HEX FACES Inches	EAN	MASTER PACK	SHELF PACK
10502738	5.0	73	150	3.9	5/32	5709131135579	24	1
10502739	6.0	114	191	4.8	3/16	5709131133490	24	1
10502740	6.0	323	400	4.8	3/16	5709131133957	24	1
10502741	8.0	114	191	5.6	7/32	5709131133513	24	1
10502742	8.0	323	400	5.6	7/32	5709131133971	24	1
10502744	10.0	114	191	7.9	5/16	5709131133537	24	1
10502745	10.0	323	400	7.9	5/16	5709131133995	24	1
10502747	11.0	114	191	7.9	5/16	5709131133551	24	1
10502748	12.0	114	191	7.9	5/16	5709131133575	24	1
10502749	12.0	323	400	7.9	5/16	5709131134015	24	1
10502751	13.0	114	191	7.9	5/16	5709131133599	24	1
10502752	13.0	323	400	7.9	5/16	5709131134039	24	1
10502754	14.0	126	191	7.9	5/16	5709131133612	24	1
10502755	14.0	335	400	7.9	5/16	5709131134053	24	1
10502756	15.0	126	191	7.9	5/16	5709131133636	24	1
10502757	16.0	126	191	7.9	5/16	5709131133650	24	1
10502758	16.0	335	400	7.9	5/16	5709131134077	24	1
10502760	17.0	126	191	7.9	5/16	5709131133674	24	1
10502761	18.0	126	191	7.9	5/16	5709131133698	24	1
10502762	18.0	335	400	7.9	5/16	5709131134091	24	1
10502764	19.0	126	191	7.9	5/16	5709131133711	24	1
10502765	19.0	335	400	7.9	5/16	5709131134114	24	1
10502766	20.0	126	191	7.9	5/16	5709131133735	24	1
10502767	20.0	335	400	7.9	5/16	5709131134138	24	1
10502769	22.0	126	191	7.9	5/16	5709131133759	24	1
10502770	22.0	335	400	7.9	5/16	5709131134152	24	1
10502772	24.0	126	191	7.9	5/16	5709131133773	24	1
10502773	24.0	335	400	7.9	5/16	5709131134176	24	1
10502774	25.0	126	191	7.9	5/16	5709131133797	24	1
10502775	25.0	335	400	7.9	5/16	5709131134190	24	1
10502776	26.0	126	191	11.1	7/16	5709131133810	24	1
10502777	26.0	335	400	11.1	7/16	5709131134213	24	1
10502778	28.0	175	240	11.1	7/16	5709131133834	24	1
10502779	28.0	335	400	11.1	7/16	5709131134237	24	1
10502780	30.0	175	240	11.1	7/16	5709131133858	24	1
10502781	30.0	335	400	11.1	7/16	5709131134251	16	1
10502782	32.0	175	240	11.1	7/16	5709131133872	24	1
10502783	32.0	335	400	11.1	7/16	5709131134275	16	1
10502784	35.0	175	240	11.1	7/16	5709131133896	24	1
10502785	35.0	335	400	11.1	7/16	5709131134312	16	1
10502786	36.0	335	400	11.1	7/16	5709131134336	16	1
10502787	38.0	175	240	11.1	7/16	5709131133919	24	1
10502788	40.0	175	240	11.1	7/16	5709131133933	24	1

### AUGER DRILL BIT EXTENSIONS



10502790

ITEM NO.	DESCRIPTION	EAN	MASTER PACK	SHELF PACK
10502789	5/16" / 7,9mm Extension 450mm for Auger Ø10 - 25mm	5709131134756	25	5
10502790	7/16" / 11,1mm Extension 450mm for Auger Ø26 - 40mm	5709131134756	25	5

## MASONRY



### SPEEDHAMMER™ POWER DRILL BIT SETS



10507538

ITEM NO.	DESCRIPTION	EAN	MASTER PACK	SHELF PACK
10507538	SPDH Power 9pc set: 6/6/8 x 110, 6/6/8/8/10/12 x 160mm	5706915075380	6	1

### SPEEDHAMMER™ PLUS DRILL BIT SETS



10502089



10507111

ITEM NO.	DESCRIPTION	EAN	MASTER PACK	SHELF PACK
10502089	SPDH Plus 5pc set: 5/6/8/10/12 x 160mm	5709131268871	48	16
10507110	SPDH Plus 9pc set: 5/5,5/6 x 110, 5,5/6/6/8/10/12 x 160mm	5706915071108	6	1
10507111	SPDH Plus 9pc set: 5/6/6/8 x 110, 6/6/8/10/12 x 160mm	5706915071115	6	1

### SPEEDHAMMER™ PLUS DEMOLITION CHISELS



10502201

ITEM NO.	DESCRIPTION	EAN	MASTER PACK	SHELF PACK
10502201	Demolition Chisels 3pc set: Pointed, Flat & Spade	5709131285571	-	1



## CORDLESS MULTI DRILL BIT CASSETTES

**CORDLESS  
MULTI**



10501938



10501939



10501940

ITEM NO.	DESCRIPTION	EAN	MASTER PACK	SHELF PACK
10501938	Cordless Multi 5pc set: 4/5/6/8/10mm	5709131247715	48	6
10501939	Cordless Multi 5pc set: 5/5.5/6/8/10mm	5709131247692	48	6
10501940	Cordless Multi 7pc set: 4/5/6/7/8/10/12mm	5709131247708	48	6

## MASONRY DRILL BIT CASSETTES

**MASONRY**



10501892



10501893

ITEM NO.	DESCRIPTION	EAN	MASTER PACK	SHELF PACK
10501892	Masonry 5pc set: 4/5/6/8/10mm	5709131248125	48	6
10501893	Masonry 7pc set: 4/5/6/7/8/10/12mm	5709131248149	48	6

## GRANITE DRILL BIT CASSETTES

**GRANITE**



10501917



10501918

ITEM NO.	DESCRIPTION	EAN	MASTER PACK	SHELF PACK
10501917	Granite 5pc set: 4/5/6/8/10mm	5709131248187	48	6
10501918	Granite 7pc set: 4/5/6/7/8/10/12mm	5709131248194	48	6



## GLASS AND TILE DRILL BITS

*GLASS & TILES*



10507912

ITEM NO.	DESCRIPTION	EAN	MASTER PACK	SHELF PACK
10507912	Glass & Tile 5 pc set: 4/5/6/8/11mm	5706915079128	120	10

## DIAMOND DRILL BITS

*DIAMOND*



10507900

ITEM NO.	DESCRIPTION	EAN	MASTER PACK	SHELF PACK
10507900	Diamond 4pc set: 5/6/7/8mm	5706915079005	60	1

## TURBOMAX™ HSS DRILL BIT SETS

*TURBO  
MAX*



10502234



10503992



10502233

ITEM NO.	DESCRIPTION	EAN	MASTER PACK	SHELF PACK
10502234	HSS Turbomax, 5pc set: 4/5/6/8/10mm	5709131266167	48	6
10503992	HSS Turbomax, 15pc set: 1,5 to 10,0mm	5706915039924	6	1
10502233	HSS Turbomax, 19pc set in metal case: 1,0 - 10,0mm in steps of 0,5mm	5709131240693	5	1



## METAL

### HSS PRO COBALT DRILL BIT SETS



10502570



10503990



10502569



10503730

ITEM NO.	DESCRIPTION	EAN	MASTER PACK	SHELF PACK
10502570	HSS Cobalt, 5pc set: 4/5/6/8/10mm	5709131282464	48	6
10503990	HSS Cobalt, 15pc set: 1,5 to 10,0mm	5706915039900	6	1
10502569	HSS Cobalt, 19pc set in metal case: 1,0 - 10,0mm in steps of 0,5mm	5709131282433	25	5
10503730	HSS Cobalt, 25pc set in metal case: 1,0 - 13,0mm in steps of 0,5mm	5706915037302	4	1

### HSS TITANIUM DRILL BIT SETS



10502604



10503991



10502603

ITEM NO.	DESCRIPTION	EAN	MASTER PACK	SHELF PACK
10502604	HSS Titanium, 5pc set: 4/5/6/8/10mm	5709131282471	48	6
10503991	HSS Titanium, 15pc set: 1,5 to 10,0mm	5706915039917	6	1
10502603	HSS Titanium, 19pc set in metal case: 1,0 - 10,0mm in steps of 0,5mm	5709131282440	25	5

## HSS PRO DRILL BIT SETS



10502499



10503989



10502500



10502504

ITEM NO.	DESCRIPTION	EAN	MASTER PACK	SHELF PACK
10502499	HSS Pro, 5pc set: 4/5/6/8/10mm	5709131282457	48	6
10503989	HSS Pro, 15pc set: 1,5 to 10,0mm	5706915039894	6	1
10502500	HSS Pro, 19pc set in metal case: 1,0 - 10,0mm in steps of 0,5mm	5709131284628	20	5
10502504	HSS Pro, 25pc set in metal case: 1,0 - 13,0mm in steps of 0,5mm	5709131284659	16	4

## MIXED DRILL BIT SET



10503993

ITEM NO.	DESCRIPTION	EAN	MASTER PACK	SHELF PACK
10503993	Combi, 15pc set: HSS Pro: 2/3/3,5/4/5/6/8mm; Cordless Multi: 4/5/6/8mm; Brad Point: 3/4/6/8mm	5706915039931	6	1

## BLUE GROOVE POWER WOOD BORING BIT SETS



10507720



10507764

ITEM NO.	DESCRIPTION	EAN	MASTER PACK	SHELF PACK
10507720	Blue Groove Power, 3pc set: 14/16/18mm	5706915077209	36	1
10507764	Blue Groove Power, 3pc set: 20/22/25mm	5706915077643	36	1



## WOOD

### BLUE GROOVE 6X WOOD BORING BIT SETS



10506627



10506628



10507604

ITEM NO.	DESCRIPTION	EAN	MASTER PACK	SHELF PACK
10506627	Blue Groove 6X, 3pc set: 20/22/25mm	5706915066272	6	1
10506628	Blue Groove 6X, 6pc set: 16/18/20/22/25/32mm	5706915066289	6	1
10507604	Blue Groove 6X, 6pc set: 14/16/18/20/22/25mm	5706915076042	6	1

### BLUE GROOVE 4X FLAT DRILL BIT SETS



10502826



10506629



10507603

ITEM NO.	DESCRIPTION	EAN	MASTER PACK	SHELF PACK
10502826	Blue Groove 4X, 6pc set: 10/13/16/19/22/25mm	24721253149	6	1
10506629	Blue Groove 4X, 8pc set: 12/16/18/20/22/25/28/32mm	5706915066296	6	1
10507603	Blue Groove 4X, 8pc set: 12/14/16/18/20/22/25/28mm	5706915076035	6	1

# FASTENER DRIVES & SCREWDRIVING



## IMPACT PERFORMANCE SERIES™ FOR MAXIMUM DURABILITY AND LONG LIFE

Based on the increasing popularity and frequency of use of impact drivers on the jobsite, IRWIN® offers a broad range of impact fastener drive bits and accessories. While some screwdriving bits are simply compatible with impact drills and drivers, IRWIN® Impact Performance Series™ fastener drive bits are engineered for maximum durability and long life with impact drivers. These bits are designed with precision tip geometry so they fit fasteners more precisely, which reduces stripping and cam-out. Manufactured with heavy-duty, cold-forged, high-grade steel, they'll withstand extremely high torque output. Plus, a black oxide finish resists corrosion and increases the life of the bit.

## DOUBLE-ENDED BITS

**PRECISION TIP GEOMETRY**

**POWER GROOVE**

**BLACK OXIDE FINISH**

**DOUBLELOK TECHNOLOGY**

**PRECISION TIP**  
BETTER FIT. LESS STRIPPING.\*

**1923375**

**MANUFACTURED WITH HEAVY DUTY, HIGH-GRADE STEEL**

**IMPACT DOUBLE-ENDED BITS**

- DOUBLELOK TECHNOLOGY**  
Ensures both ends of the bit lock securely in impact drivers and quick-change chucks, enabling use of two tips from one bit for added convenience and extended life
- PRECISION TIP GEOMETRY**  
Delivers superior fitment, reducing stripping and cam-out
- MANUFACTURED WITH HEAVY-DUTY, HIGH-GRADE STEEL**  
To withstand high torque output
- BLACK OXIDE FINISH**  
Resists corrosion and extends the life of the bit
- POWER GROOVE**  
Designed for compatibility with IRWIN® Impact Performance Series™ Magnetic Screw-Hold Attachment



ITEM NO.	DESCRIPTION	EAN	MASTER PACK	SHELF PACK
1923372	Impact Double-Ended Insert Bit - PH1 60mm - 2pcs	5706919233724	25	5
1923373	Impact Double-Ended Insert Bit - PH1 60mm - 10pcs	5706919233731	60	10
1923375	Impact Double-Ended Insert Bit - PH2 60mm - 2pcs	5706919233755	25	5
1923376	Impact Double-Ended Insert Bit - PH2 60mm - 10pcs	5706919233762	60	10
1923377	Impact Double-Ended Power Bit - PH2 100mm - 2pcs	5706919233779	25	5
1923378	Impact Double-Ended Insert Bit - PH3 60mm - 2pcs	5706919233786	25	5
1923381	Impact Double-Ended Insert Bit - T10 60mm - 2pcs	5706919233816	25	5
1923383	Impact Double-Ended Insert Bit - T15 60mm - 2pcs	5706919233830	25	5
1923385	Impact Double-Ended Insert Bit - T20 60mm - 2pcs	5706919233854	25	5
1923386	Impact Double-Ended Power Bit - T20 100mm - 2pcs	5706919233861	25	5
1923387	Impact Double-Ended Insert Bit - T25 60mm - 2pcs	5706919233878	25	5
1923388	Impact Double-Ended Power Bit - T25 100mm - 2pcs	5706919233885	25	5
1923391	Impact Double-Ended Insert Bit - T30 60mm - 2pcs	5706919233915	25	5
1923392	Impact Double-Ended Power Bit - T30 100mm - 2pcs	5706919233922	25	5
1923405	Impact Double-Ended Insert Bit - PZ1 60mm - 2pcs	5706919234059	25	5
1923406	Impact Double-Ended Insert Bit - PZ1 60mm - 10pcs	5706919234066	60	10
1923407	Impact Double-Ended Power Bit - PZ1 100mm - 2pcs	5706919234073	25	5
1923408	Impact Double-Ended Insert Bit - PZ2 60mm - 2pcs	5706919234080	25	5
1923409	Impact Double-Ended Insert Bit - PZ2 60mm - 10pcs	5706919234097	60	10
1923410	Impact Double-Ended Power Bit - PZ2 100mm - 2pcs	5706919234103	25	5
1923411	Impact Double-Ended Insert Bit - PZ3 60mm - 2pcs	5706919234110	25	5
1923412	Impact Double-Ended Insert Bit - PZ3 60mm - 10pcs	5706919234127	60	10
1923227	Impact Double-Ended Power Bit - PZ3 100mm - 2pcs	5706919232277	25	5

Compatible with IRWIN® Impact Performance Series Magnetic Screw-Hold Attachment\*\*

\*vs. standard screwdriving bits \*\*excludes T40, SL10-12, SL12-14, Hex 6 mm, Hex 8 mm, Hex 1/4"



# FASTENER DRIVES & SCREWDRIVING

## IMPACT SINGLE ENDED BITS

ITEM NO.	DESCRIPTION	EAN	MASTER PACK	SHELF PACK
1923286	Impact Single-Ended Insert Bit - PH1 25mm - 2pcs	5706919232864	25	5
1923287	Impact Single-Ended Insert Bit - PH1 25mm - 10pcs	5706919232871	25	5
1923289	Impact Single-Ended Insert Bit - PH2 25mm - 2pcs	5706919232895	25	5
1923290	Impact Single-Ended Insert Bit - PH2 25mm - 10pcs	5706919232901	25	5
1923322	Impact Single-Ended Power Bit - PH2 50mm - 2pcs	5706919233229	25	5
1923323	Impact Single-Ended Insert Bit - PH3 25mm - 2pcs	5706919233236	25	5
1923326	Impact Single-Ended Insert Bit - T10 25mm - 2pcs	5706919233267	25	5
1923328	Impact Single-Ended Insert Bit - T15 25mm - 2pcs	5706919233281	25	5
1923330	Impact Single-Ended Insert Bit - T20 25mm - 2pcs	5706919233304	25	5
1923332	Impact Single-Ended Power Bit - T20 50mm - 2pcs	5706919233328	25	5
1923333	Impact Single-Ended Insert Bit - T25 25mm - 2pcs	5706919233335	25	5
1923334	Impact Single-Ended Power Bit - T25 50mm - 2pcs	5706919233342	25	5
1923335	Impact Single-Ended Insert Bit - T27 25mm - 2pcs	5706919233359	25	5
1923337	Impact Single-Ended Insert Bit - T30 25mm - 2pcs	5706919233373	25	5
1923339	Impact Single-Ended Power Bit - T30 50mm - 2pcs	5706919233397	25	5
1923340	Impact Single-Ended Insert Bit - T40 25mm - 2pcs	5706919233403	25	5
1923342	Impact Single-Ended Insert Bit - HEX3 25mm - 2pcs	5706919233427	25	5
1923344	Impact Single-Ended Insert Bit - HEX4 25mm - 2pcs	5706919233441	25	5
1923346	Impact Single-Ended Insert Bit - HEX5 25mm - 2pcs	5706919233465	25	5
1923348	Impact Single-Ended Insert Bit - HEX6 25mm - 2pcs	5706919233489	25	5
1923350	Impact Single-Ended Insert Bit - HEX8 25mm - 2pcs	5706919233502	25	5
1923352	Impact Single-Ended Insert Bit - P21 25mm - 2pcs	5706919233526	25	5
1923353	Impact Single-Ended Insert Bit - P21 25mm - 10pcs	5706919233533	25	5
1923354	Impact Single-Ended Power Bit - P21 50mm - 2pcs	5706919233540	25	5
1923355	Impact Single-Ended Insert Bit - P22 25mm - 2pcs	5706919233557	25	5
1923356	Impact Single-Ended Insert Bit - P22 25mm - 10pcs	5706919233564	25	5
1923358	Impact Single-Ended Power Bit - P22 50mm - 2pcs	5706919233588	25	5
1923359	Impact Single-Ended Insert Bit - P23 25mm - 2pcs	5706919233595	25	5
1923360	Impact Single-Ended Insert Bit - P23 25mm - 10pcs	5706919233601	25	5
1923361	Impact Single-Ended Power Bit - P23 50mm - 2pcs	5706919233618	25	5
1923362	Impact Single-Ended Insert Bit - SLOT 3mm - 25mm - 2pcs	5706919233625	25	5
1923364	Impact Single-Ended Insert Bit - SLOT 4.5mm - 25mm - 2pcs	5706919233649	25	5
1923366	Impact Single-Ended Insert Bit - SLOT 5.5mm - 25mm - 2pcs	5706919233663	25	5
1923368	Impact Single-Ended Insert Bit - SLOT 6.5mm - 25mm - 2pcs	5706919233687	25	5
1923370	Impact Single-Ended Insert Bit - SLOT 8mm - 25mm - 2pcs	5706919233700	25	5

\*vs. standard screwdriving bits \*\*excludes T40, SL10-12, SL12-14, Hex 6 mm, Hex 8 mm & Hex 1/4"

**PRECISION TIP GEOMETRY** delivers superior fitment, reducing stripping and cam-out  
**MANUFACTURED WITH HEAVY-DUTY, HIGH-GRADE STEEL** to withstand high torque output  
**POWER GROOVE** designed for compatibility with IRWIN® Impact Performance Series™ Magnetic Screw-Hold Attachment



1923322

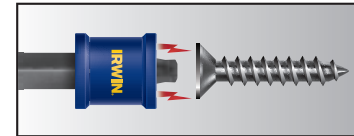
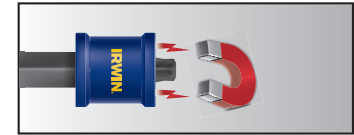
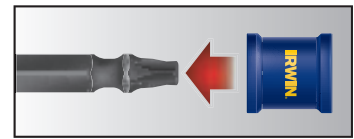

Compatible with IRWIN® Impact Performance Series Magnetic Screw-Hold Attachment\*\*



BETTER FIT. LESS STRIPPING.\*

## 20-PIECE PRO-PAK™ SETS

ITEM NO.	DESCRIPTION	EAN	MASTER PACK	SHELF PACK
1923321	Impact Single-Ended Insert Bit - PH2 25mm - 20pcs	5706919233321	10	1
1923331	Impact Single-Ended Insert Bit - T20 25mm - 20pcs	5706919233311	10	1
1923338	Impact Single-Ended Insert Bit - T30 25mm - 20pcs	5706919233380	10	1
1923357	Impact Single-Ended Insert Bit - P22 25mm - 20pcs	5706919233571	60	10



1923321

## QUICK-CHANGE IMPACT BIT EXTENSIONS

Have a patented jaw design that is compatible with all 1/4" hex shank accessories including insert bits

ITEM NO.	DESCRIPTION	EAN	MASTER PACK	SHELF PACK
1923502	Impact Quick-Change Extension Bit - 2.5" - 1pc	5706919235025	48	3
1923413	Impact Quick-Change Extension Bit - 6" - 1pc	5706919234134	48	3
1923414	Impact Quick-Change Extension Bit - 12" - 1pc	5706919234141	48	3



1923413

## IMPACT BIT HOLDERS

Impact bit holders and attachments feature rare earth magnets which are four times more powerful than standard magnets to hold fasteners securely

ITEM NO.	DESCRIPTION	EAN	MASTER PACK	SHELF PACK
1923228	Impact Bit Holder - 3" - 1pc	5706919232284	25	5
1923229	Impact Bit Holder - 6" - 1pc	5706919232291	25	5
1923501	Impact Magnetic Screw Holder - 1pc	5706919235018	25	5



1923228



1923501



## IMPACT POCKET CASES

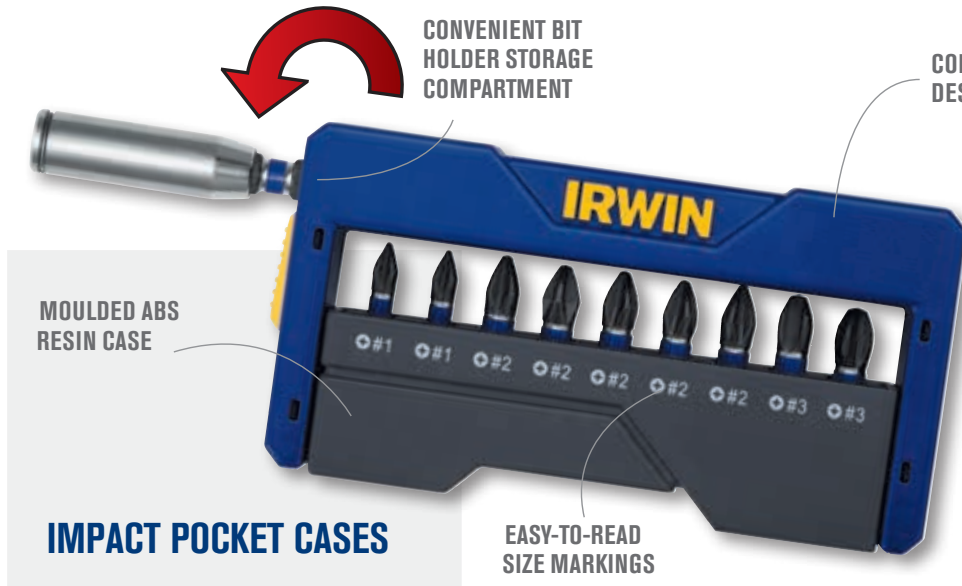

- 1. COMPACT, PORTABLE DESIGN**  
Allows for easy transport to and from the worksite, and ease-of-use while on the job
- 2. MOULDED ABS RESIN CASE**  
Moulded ABS resin case holds up to rigours of daily use
- 3. EASY-TO-READ SIZE MARKINGS**  
Easy-to-read size markings provide simple identification of set contents
- 4. CONVENIENT BIT HOLDER STORAGE COMPARTMENT**  
Incorporated into top of case I (insert bit cases only)

### IMPACT POCKET CASES

#### IMPACT INSERT BIT 10 PIECE POCKET CASE SET

Holds (9) 1" insert bits and a bit holder



1923419

ITEM NO.	DESCRIPTION	EAN	MASTER PACK	SHELF PACK
1923419	Impact Insert Bit PH Set, 10pcs: 2 x PH1 / 5 x PH2 / 2 x PH3 + Bit Holder	5706919234196	36	6
1923420	Impact Insert Bit PZ Set, 10pcs: 2 x PZ1 / 5 x PZ2 / 2 x PZ3 + Bit Holder	5706919234202	36	6
1923431	Impact Insert Bit TX Set, 10pcs: T10 / 2 x T15 / 2 x T20 / 2 x T25 / T30 / T40 + Bit Holder	5706919234318	36	6
1923432	Impact Insert Bit Mixed Set, 10pcs: 4 x PZ2 / 4 x PH2 / T20 + Bit Holder	5706919234325	36	6

#### IMPACT POWER BIT 5 PIECE POCKET CASE SET

Holds (5) 2" power bits



1923434

ITEM NO.	DESCRIPTION	EAN	MASTER PACK	SHELF PACK
1923433	Impact Power Bit PZ / PH / TX Set, 5pcs: PZ2 x 2 / PH2 x 2 / T20	5706919234332	36	6
1923434	Impact Power Bit PH Set, 5pcs: PH2 x 5	5706919234349	36	6
1923435	Impact Power Bit PZ Set, 5pcs: PZ2 x 5	5706919234356	36	6

#### IMPACT POWER BIT 5 PIECE SET WITH MAGNETIC SCREW-HOLD ATTACHMENT



1923416

ITEM NO.	DESCRIPTION	EAN	MASTER PACK	SHELF PACK
1923416	Impact Power Bit PZ / PH Mag Set, 5pcs: 2 x PZ2 / 2 x PH2 plus 1903524	5706919234165	25	5
1923417	Impact Power Bit PH Mag Set, 5pcs: 4 x PH2 plus 1903524	5706919234172	25	5
1923418	Impact Power Bit PZ Mag Set, 5pcs: 4 x PZ2 plus 1903524	5706919234189	25	5

## IMPACT PRO CASES



- 1. TWO-STEP EASY IN / OUT BIT STORAGE**  
Holds bits securely in place until ready for use
- 2. MOULDED ABS RESIN CASE**  
Moulded ABS resin case holds up to rigours of daily use
- 3. FULL-LENGTH METAL PIN IN HINGE**  
For added durability and life
- 4. SECURE CLOSURE**  
Easy-to-use sliding latch design keeps case securely closed when not in use

### IMPACT BIT 22 PIECE PRO CASE SET

ITEM NO.	DESCRIPTION	EAN	MASTER PACK	SHELF PACK
1923436	PH1 X 2 / PH2 X 4 / PH3 X 1 / PZ1 X 2 / PZ2 X 4 / PZ3 X 1 / TX20 X 4 / TX30 X 3 / 1903524	5706919234363	6	1



### IMPACT BIT 32 PIECE PRO CASE SET

ITEM NO.	DESCRIPTION	EAN	MASTER PACK	SHELF PACK
1923437	Insert Bits (25mm) - PH1 x 2 / PH2 x 3 / PH3 x 2 / PZ1 x 2 / PZ2 x 3 / PZ3 x 2 / TX20 x 3 / TX30 x 2 / TX25 x 2 Power Bit (50mm) - PH2 x 5 / PZ x 5 / 3" Holder	5706919234370	6	1







## SCREWDRIVING BITS

IRWIN® offers a full line of screwdriving bits designed for a number of applications. All bits are manufactured with industrial-grade S2 steel for long life and durability. Insert bits are engineered for use in hand-driving applications or with power tools when used with the IRWIN® insert bit holder. Power bits are specifically designed for the higher torque requirements of power tools. They are designed to provide more clearance between the power tool and the fastener.

### PHILLIPS, INSERT BITS

	ITEM NO.	DESCRIPTION	EAN	MASTER PACK	SHELF PACK
 10504388	10504387	Phillips Ph1 - 1/4"/25mm - 2 pcs	5706915043877	10	1
	10504388	Phillips Ph2 - 1/4"/25mm - 2 pcs	5706915043884	10	1
	10504389	Phillips Ph3 - 1/4"/25mm - 2 pcs	5706915043891	10	1
	10504390	Phillips Ph1 - 1/4"/50mm - 2 pcs	5706915043907	10	1
	10504391	Phillips Ph2 - 1/4"/50mm - 2 pcs	5706915043914	10	1
	10504336	Phillips Ph2 - 1/4"/50mm - 5 pcs	5706915043365	10	1
	10504330	Phillips Ph1 - 1/4"/25mm - 10 pcs	5706915043303	10	1
	10504331	Phillips Ph2 - 1/4"/25mm - 10 pcs	5706915043310	10	1
	10504332	Phillips Ph3 - 1/4"/25mm - 10 pcs	5706915043327	10	1

### PHILLIPS, INSERT BITS - TITANIUM COATED

	ITEM NO.	DESCRIPTION	EAN	MASTER PACK	SHELF PACK
 10504392	10504392	Phillips Ph2 TiN - 1/4"/25mm - 2 pcs	5706915043921	10	1
	10504333	Phillips Ph1 TiN - 1/4"/25mm - 10 pcs	5706915043334	10	1
	10504334	Phillips Ph2 TiN - 1/4"/25mm - 10 pcs	5706915043341	10	1
	10504335	Phillips Ph3 TiN - 1/4"/25mm - 10 pcs	5706915043358	10	1

### PHILLIPS, POWER BITS

	ITEM NO.	DESCRIPTION	EAN	MASTER PACK	SHELF PACK
 10504396	10504395	Phillips Ph1 - 1/4"/50mm - 2 pcs	5706915043952	10	1
	10504396	Phillips Ph2 - 1/4"/50mm - 2 pcs	5706915043969	10	1
	10504363	Phillips Ph1 - 1/4"/50mm - 5 pcs	5706915043631	10	1
	10504364	Phillips Ph2 - 1/4"/50mm - 5 pcs	5706915043648	10	1
	10504365	Phillips Ph2 - 1/4"/70mm - 1 pcs	5706915043655	10	1
	10504366	Phillips Ph2 - 1/4"/90mm - 1 pcs	5706915043662	10	1
	10504367	Phillips Ph3 - 1/4"/50mm - 5 pcs	5706915043679	10	1

### POZIDRIV, INSERT BITS

	ITEM NO.	DESCRIPTION	EAN	MASTER PACK	SHELF PACK
 10504398	10504397	Pozidriv Pz1 - 1/4"/25mm - 2 pcs	5706915043976	10	1
	10504398	Pozidriv Pz2 - 1/4"/25mm - 2 pcs	5706915043983	10	1
	10504399	Pozidriv Pz3 - 1/4"/25mm - 2 pcs	5706915043990	10	1
	10504400	Pozidriv Pz1 - 1/4"/50mm - 2 pcs	5706915044003	10	1
	10504401	Pozidriv Pz2 - 1/4"/50mm - 2 pcs	5706915044010	10	1
	10504338	Pozidriv Pz1 - 1/4"/25mm - 10 pcs	5706915043389	10	1
	10504339	Pozidriv Pz2 - 1/4"/25mm - 10 pcs	5706915043396	10	1
	10504340	Pozidriv Pz3 - 1/4"/25mm - 10 pcs	5706915043402	10	1
	10504344	Pozidriv Pz2 - 1/4"/50mm - 5 pcs	5706915043440	10	1

### POZIDRIV, INSERT BITS - TITANIUM COATED

	ITEM NO.	DESCRIPTION	EAN	MASTER PACK	SHELF PACK
 10504402	10504402	Pozidriv Pz2 TiN - 1/4"/25mm - 2 pcs	5706915044027	10	1
	10504341	Pozidriv Pz1 TiN - 1/4"/25mm - 10 pcs	5706915043419	10	1
	10504342	Pozidriv Pz2 TiN - 1/4"/25mm - 10 pcs	5706915043426	10	1
	10504343	Pozidriv Pz3 TiN - 1/4"/25mm - 10 pcs	5706915043433	10	1

\* Bulk packed products are priced per single item and can only be ordered in multiples of shelf pack quantity

# FASTENER DRIVES & SCREWDRIVING

## POZIDRIV, POWER BITS

ITEM NO.	DESCRIPTION	EAN	MASTER PACK	SHELF PACK
10504406	Pozidriv Pz2 - 1/4"/50mm - 2 pcs	5706915044065	10	1
10504368	Pozidriv Pz1 - 1/4"/50mm - 5 pcs	5706915043686	50	1
10504369	Pozidriv Pz2 - 1/4"/50mm - 5 pcs	5706915043693	50	1
10504370	Pozidriv Pz2 - 1/4"/70mm - 1 pcs	5706915043709	10	1
10504371	Pozidriv Pz2 - 1/4"/90mm - 1 pcs	5706915043716	10	1
10504372	Pozidriv Pz3 - 1/4"/50mm - 5 pcs	5706915043723	10	1



## PHILLIPS/POZIDRIV, DOUBLE-ENDED BITS

ITEM NO.	DESCRIPTION	EAN	MASTER PACK	SHELF PACK
10504393	Phillips Ph1/Ph2 - Double End 50mm - 2 pcs	5706915043938	10	1
10504394	Phillips Ph2/Ph2 - Double End 50mm - 2 pcs	5706915043945	10	1
10504403	Pozidriv Pz1/Pz2 - Double End 50mm - 2 pcs	5706915044034	10	1
10504404	Pozidriv Pz2/Pz2 - Double End 50mm - 2 pcs	5706915044041	10	1



## TORX, INSERT BITS

ITEM NO.	DESCRIPTION	EAN	MASTER PACK	SHELF PACK
10504837	Torx T15 - 1/4"/25mm - 2 pcs	5706915048377	200	10
10504838	Torx T20 - 1/4"/25mm - 2 pcs	5706915048384	200	10
10504839	Torx T25 - 1/4"/25mm - 2 pcs	5706915048391	200	10
10504840	Torx T30 - 1/4"/25mm - 2 pcs	5706915048407	200	10
10504351	Torx T10 - 1/4"/25mm - 10 pcs	5706915043518	10	1
10504352	Torx T15 - 1/4"/25mm - 10 pcs	5706915043525	10	1
10504353	Torx T20 - 1/4"/25mm - 10 pcs	5706915043532	10	1
10504354	Torx T25 - 1/4"/25mm - 10 pcs	5706915043549	10	1
10504355	Torx T27 - 1/4"/25mm - 10 pcs	5706915043556	10	1
10504356	Torx T30 - 1/4"/25mm - 10 pcs	5706915043563	10	1
10504357	Torx T40 - 1/4"/25mm - 10 pcs	5706915043570	10	1



## TORX, POWER BITS

ITEM NO.	DESCRIPTION	EAN	MASTER PACK	SHELF PACK
10504373	Torx T20 - 1/4"/50mm - 5 pcs	5706915043730	10	1
10504374	Torx T25 - 1/4"/50mm - 5 pcs	5706915043747	10	1
10504375	Torx T30 - 1/4"/50mm - 5 pcs	5706915043754	10	1
10504376	Torx T40 - 1/4"/50mm - 5 pcs	5706915043761	10	1



## SLOTTED, INSERT BITS

ITEM NO.	DESCRIPTION	EAN	MASTER PACK	SHELF PACK
10504358	Slotted 0,5 x 3,0mm - 1/4"/25mm - 10 pcs	5706915043587	60	10
10504359	Slotted 0,6 x 4,5mm - 1/4"/25mm - 10 pcs	5706915043594	60	10
10504360	Slotted 0,8 x 5,5mm - 1/4"/25mm - 10 pcs	5706915043600	60	10
10504361	Slotted 1,2 x 6,5mm - 1/4"/25mm - 10 pcs	5706915043617	60	10
10504362	Slotted 1,6 x 8,0mm - 1/4"/25mm - 10 pcs	5706915043624	60	10



## HEXAGONAL, INSERT BITS

ITEM NO.	DESCRIPTION	EAN	MASTER PACK	SHELF PACK
10504346	Hexagonal 3,0mm - 1/4"/25mm - 10 pcs	5706915043464	60	10
10504347	Hexagonal 4,0mm - 1/4"/25mm - 10 pcs	5706915043471	60	10
10504348	Hexagonal 5,0mm - 1/4"/25mm - 10 pcs	5706915043488	60	10
10504349	Hexagonal 6,0mm - 1/4"/25mm - 10 pcs	5706915043495	60	10
10504350	Hexagonal 8,0mm - 1/4"/25mm - 10 pcs	5706915043501	60	10



## GRABIT JARS

ITEM NO.	DESCRIPTION	EAN	MASTER PACK	SHELF PACK
10504383	Grabit Jar Pozidriv Pz2 - 1/4"/25mm, 250 pcs	5706915043839	4	1
10504384	Grabit Jar Phillips Ph2 - 1/4"/25mm, 250 pcs	5706915043846	4	1



## POCKET CASES

CONVENIENT BIT HOLDER STORAGE COMPARTMENT

MOULDED ABS RESIN CASE

### PORTABLE, DURABLE CASE THAT KEEPS BITS ORGANISED

IRWIN® Pocket Cases feature a compact, portable design that makes it simple to take the bits you need to get the job done. The convenient moulded ABS resin cases hold up to anything the jobsite can throw at them and include easy-to-read size markings for simple identification of the set contents. Plus, the 10-piece pocket case features an easy-to-access bit holder storage compartment right on top.



COMPACT, PORTABLE DESIGN

EASY-TO-READ SIZE MARKINGS

- 1. COMPACT, PORTABLE DESIGN**  
Compact, portable design allows for easy transport to and from the worksite, and ease-of-use while on the job
- 2. MOULDED ABS RESIN CASE**  
Moulded ABS resin case holds up to rigors of daily use
- 3. EASY-TO-READ SIZE MARKINGS**  
Easy-to-read size markings provide simple identification of set contents
- 4. CONVENIENT BIT HOLDER STORAGE COMPARTMENT**  
Incorporated into top of case (insert bit cases only)

### SMALL POCKET CASES



1868194

ITEM NO.	DESCRIPTION	EAN	MASTER PACK	SHELF PACK
1868193	IR 5PC PB Pocket Set (PH-PZ-TX): PB assorted, 5pc set: PH2 / PZ2 / T15 / T20 / T25	5706918681939	-	6
1868194	IR 5PC PB Pocket Set (PH-PZ-SL): PB assorted, 5pc set: PH1 / PH2 / PZ1 / PZ2 / SL6.5	5706918681946	-	6

### LARGE POCKET CASES



1868195

ITEM NO.	DESCRIPTION	EAN	MASTER PACK	SHELF PACK
1868195	IR 10PC IB Pocket Set (PH): IB Philips, 10pc set: 2xPH1 / 5xPH2 / 2xPH3 + Bit Holder	5706918681953	-	6
1868196	IR 10PC IB Pocket Set (PZ): IB Pozidriv, 10pc set: 2xPZ1 / 5xPZ2 / 2xPZ3 + Bit Holder	5706918681960	-	6
1868197	IR 10PC IB Pocket Set (TX): IB Torx, 10pc set: T10/2xT15/2xT20/2xT25/T30/T40 + Bit Holder	5706918681977	-	6
1868198	IR 10PC IB Pocket Set (PH2-PZ2-T20): IB assorted, 10pc set: 4xPZ2 / 4xPH2 / T20 + Bit Holder	5706918681984	-	6
1868199	IR 10PC IB Pocket Set (PH-PZ-TX): IB assorted, 10pc set: PZ1/PZ2/PZ3/PH1/PH2/PH3/T15/T20/T25 + Bit Holder	5706918681991	-	6
1868200	IR 10PC IB Pocket Set (PH-PZ): IB assorted, 10pc set: PZ1 / 4xPZ2 / PZ3 / 3xPH2 + Bit Holder	5706918682004	-	6



## DRAWER CASES



### COMPACT, EASY-TO-STORE CASE THAT CAN ORGANISE A WIDE VARIETY OF BITS

IRWIN® Drawer Cases feature a compact, flat design for enhanced portability and convenient storage in drawers and tool cabinets. The durable moulded ABS resin cases hold up to the daily rigors of shop-life and anything the jobsite can throw at them. The easy-to-read size markings make for simple identification of the set contents, and when not in use, the case stays securely closed with an easy-to-use sliding latch.

- 1. COMPACT, PORTABLE DESIGN**  
Compact, flat design for convenient storage in drawers and tool cabinets
- 2. MOULDED ABS RESIN CASE**  
Moulded ABS resin case holds up to rigors of daily use
- 3. EASY-TO-READ SIZE MARKINGS**  
Easy-to-read size markings provide simple identification of set contents
- 4. SECURE CLOSURE**  
Easy-to-use sliding latch design keeps case securely close when not in use

### SMALL DRAWER CASES

ITEM NO.	DESCRIPTION	EAN	MASTER PACK	SHELF PACK
1868251	IR 30PC SL DRAWER SET ASSORTED: IB assorted, 31pc small drawer case: PH1/2xPH2/PH3/PZ1/2xPZ2/PZ3/SL4-5/SL6-8/SL8-10/HEX4/HEX5/HEX6/2xT10/4xT15/4xT20/3xT25/2xT30/T40 + Bit Holder	5706918682516	-	6

### LARGE DRAWER CASES

ITEM NO.	DESCRIPTION	EAN	MASTER PACK	SHELF PACK
1868252	IR 58PC LG DRAWER SET ASSORTED: IB/PB assorted, 58pc large drawer case: 3xPH1/10xPH2/2xPH3/3xPZ1/10xPZ2/2xPZ3/SL3-4/SL4-5/SL6-8/SL8-10/HEX3/HEX4/HEX5/HEX6/2xT10/2xT15/2xT20/2xT25/2xT30/2xT40 + Powerbits PH2/PZ1/PZ2/PZ3/T15/T20/T25 + Bit Holder	5706918682523	-	6



1868252



## LARGE BIT SETS



10504385



10504386



10504382

ITEM NO.	DESCRIPTION	EAN	MASTER PACK	SHELF PACK
10504385	SCB, 30pc set: PH1, 5xPH2, PH3, PZ1, 5xPZ2, PZ3, T20, T25, T30, T40, SL6-8, SL8-10, SL10-12, Nut Set: 6, 8, 10, 12, Double ends: PH2/PH2, PZ2/PZ1, 2xPZ2/PZ2, Bit Holder	5706915043853	12	6
10504386	SCB, 31pc set: PH1, 5xPH2, PH3, PZ1, 5xPZ2, PZ3, 2xPH2TiN, 2xPZ2TiN, SL6-8, SL8-10, SL10-12, Powerbits: 3xPH2, 3xPZ2, Double ends: PH2/PH2, PZ2/PZ1, PZ2/PZ2, Bit Holder	5706915043860	12	6
10504382	Bit Dispenser, 270pc set: PZ2 50mm, PZ1 50mm, PH2 50mm, PH1 50mm, 1/4" Bit Holder, PZ2 TiN, PZ3, PZ2, PZ1, PH2 TiN, PH3, PH2, PH1	5706915043822	4	1
1840465	21pcs Fastener Drive Set: 10x PH2, 5x SQ2, 5x SL8-10, Magnetic Drive Guide	5706918404651	6	1

## BIT HOLDERS



10504377



10504378



10504379



10504380



10504381

ITEM NO.	DESCRIPTION	EAN	MASTER PACK	SHELF PACK
10504377	50mm Magnetic Bit Holder 1/4"	5706915043778	200	10
10504378	75mm Magnetic Bit Holder 1/4"	5706915043785	200	10
10504379	SDS Magnetic Bit Holder	5706915043792	200	10
10504380	Quick-Release Bit Holder 1/4"	5706915043808	200	10
10504381	80mm Screw Drive Guide 9.5mm diameter	5706915043815	200	10

## BOLT-GRIP™ BOLT EXTRACTORS

Professionals don't waste time fighting rounded-off, rusted tight or painted-over bolts. They reach for the BOLT-GRIP. A unique, reverse spiral flute design securely grips and removes stubborn nuts and bolts.



54125



10504634



10504635



394100

ITEM NO.	DESCRIPTION	EAN	MASTER PACK	SHELF PACK
10504634	5 Piece Base Set: 3/8", 7/16" (11mm), 1/2", 9/16" (14mm), 5/8" (16mm)	0024721012579	-	5
10504635	5 Piece Expansion Set: 5/16" (8mm), 10mm, 13mm, 11/16", 3/4" (19mm)	0024721016126	-	5
394100	Powergrip Set: 3/16" - 1/2", 7 pcs	0024721037633	-	5
54125	5 Piece Speciality Set: 3/4" (19mm), 13/16" (21mm), 7/8" (22mm), 15/16" (24mm), 1" (25mm)	0024721541253	-	1
10504381	80mm Screw Drive Guide 9.5mm diameter	5706915043815	200	10

**MAXIMUM GRIPPING POWER** reverse spiral flutes are designed to bite down  
**HIGH CARBON STEEL** is tougher than tool steel, ensuring longer life and greater durability  
**WORKS WITH MOST TOOLS** with a 3/8" square drive for use with hand ratchets, impact wrenches & air ratchets; hexagonal flats for use with flat wrench, pliers, adjustable wrench, sockets or VISE-GRIP® locking pliers  
**UNIVERSAL LOBULAR DESIGN** fits all types of fasteners





**IRWIN®**



## CIRCULAR SAW BLADES

IRWIN® now offers a comprehensive line-up of circular saw blades for professional tool users. From the jobsite, to the fine woodworking shop, IRWIN® offers a blade for every user need.

### Marples®

At the heart of quality craftsmanship lies the rich heritage of Marples® woodworking tools. Originating in 1828 in Sheffield, England, the Marples® brand has consistently stood for superior performance and ultimate precision in fine woodworking.

Marples® is traditionally famous for chisels and synonymous with high-quality woodworking tools. The new range of Circular Saw Blades made in Udine, Italy uses best-in-class manufacturing capabilities and processes giving a range fitting of the Marples® brand.



The WeldTec™ platform redefines excellence with a range of construction saw blades that combines various attributes to deliver long lasting performance.

WeldTec Technology is the welding of teeth to the circular saw blade as opposed to the traditional brazing method. This is ideal for handheld corded and cordless blades as the weld provides a stronger tooth bond in case of unexpected nail strikes or foreign objects embedded in wood.



HAND-HELD

STATIONARY

CORDLESS

CORDED

MITRE

TABLE



ONLINE CIRCULAR SAW BLADE SELECTOR

Not sure which is the right blade for the job?

Visit: [www.circularsawbladeselector.irwin.eu](http://www.circularsawbladeselector.irwin.eu)

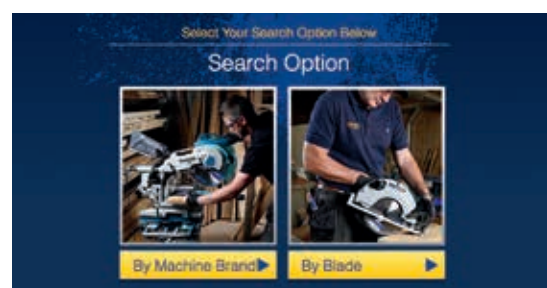



# MARPLES® CIRCULAR SAW BLADES

**1. EXTRA-SHARP, OVERSIZED CARBIDE TEETH**  
Carbide is larger and tougher than standard carbide for 3X longer life and are re-sharpenable

**2. LASER CUT BLADE BODY**  
For straighter, cleaner cuts

**3. PRECISION TENSIONING**  
For greater accuracy

**4. SPECIAL PTFE COATING WITH ALUMINIUM FLAKES**  
Helps to dissipate heat to prevent binding for smooth, cool cuts

**MARPLES® CIRCULAR SAW BLADES**

PTFE NON-STICK  
MADE IN ITALY PRODUCT

1897459

TEETH GRIND CONFIGURATION	ATB ALTERNATE TOP BEVEL		MACHINES	DIAMETER	TOOTH COUNT	ARBOR/BORE	KERF THICKNESS	TOOTH CONFIG.	
	DESCRIPTION	CATEGORY							
ATB ALTERNATE TOP BEVEL									
	<b>FEATURES</b>								
	<ul style="list-style-type: none"> <li>Teeth alternate between a right- and left-hand bevel to form a knife-like edge on either side for a cleaner cut.</li> </ul>								
	<b>HI-ATB HIGH ALTERNATE TOP BEVEL</b>								
	<b>FEATURES</b>								
	<ul style="list-style-type: none"> <li>Used for extra-fine cross-cutting</li> <li>High bevel angle increases the knife-like action at the edge of the blade</li> </ul>								
	<b>TCG TRIPLE CHIP GROUND</b>								
	<b>FEATURES</b>								
<ul style="list-style-type: none"> <li>Excels at cutting hard materials like laminates, MDF, plastics and non-ferrous metals</li> <li>Teeth alternate between a flat raking tooth and a trapezoid shaped tooth</li> </ul>									

ITEM NO.	DESCRIPTION	CATEGORY	MACHINES	DIAMETER	TOOTH COUNT	ARBOR/BORE	KERF THICKNESS	TOOTH CONFIG.
1897453	HPP 216mm/24T	Stationary	Mitre	216	24	30	2.5	ATB/N
1897454	HPP 216mm/48T	Stationary	Mitre	216	48	30	2.5	ATB/N
1897455	HPP 216mm/60T	Stationary	Mitre	216	60	30	2.5	ATB/N
1897456	HPP 250mm/48T	Stationary	Mitre	250	48	30	2.5	ATB/N
1897457	HPP 250mm/60T	Stationary	Mitre	250	60	30	2.5	ATB/N
1897458	HPP 250mm/80T	Stationary	Mitre	250	80	30	2.5	HI-ATB/N
1897459	HPP 254mm/48T	Stationary	Mitre	254	48	30	2.5	ATB/N
1897460	HPP 254mm/60T	Stationary	Mitre	254	60	30	2.5	ATB/N
1897461	HPP 254mm/80T	Stationary	Mitre	254	80	30	2.5	HI-ATB/N
1897462	HPP 260mm/48T	Stationary	Mitre	260	48	30	2.5	ATB/N
1897463	HPP 260mm/60T	Stationary	Mitre	260	60	30	2.5	ATB/N
1897464	HPP 260mm/80T	Stationary	Mitre	260	80	30	2.5	HI-ATB/N
1897465	HPP 305mm/48T	Stationary	Mitre	305	48	30	2.5	ATB/N
1897466	HPP 305mm/60T	Stationary	Mitre	305	60	30	2.5	ATB/N
1897467	HPP 305mm/96T	Stationary	Mitre	305	96	30	2.5	HI-ATB/N
1897474	HPP 250mm/24T	Stationary	Table & Mitre	250	24	30	3.2	ATB
1897475	HPP 250mm/40T	Stationary	Table & Mitre	250	40	30	3.2	ATB
1897476	HPP 250mm/60T	Stationary	Table & Mitre	250	60	30	3.2	ATB
1897477	HPP 250mm/80T	Stationary	Table & Mitre	250	80	30	3.2	ATB
1897478	HPP 300mm/24T	Stationary	Table & Mitre	300	24	30	3.2	ATB
1897479	HPP 300mm/48T	Stationary	Table & Mitre	300	48	30	3.2	ATB
1897480	HPP 300mm/60T	Stationary	Table & Mitre	300	60	30	3.2	ATB
1897468	HPP 216mm/84T	Multi	Multi	216	84	30	2.5	TCG/N
1897469	HPP 250mm/84T	Multi	Multi	250	84	30	2.5	TCG/N
1897470	HPP 254mm/84T	Multi	Multi	254	84	30	2.5	TCG/N
1897471	HPP 260mm/84T	Multi	Multi	260	84	30	2.5	TCG/N
1897472	HPP 300mm/96T	Multi	Multi	300	96	30	3.2	TCG
1897473	HPP 305mm/100T	Multi	Multi	305	100	30	2.5	TCG/N



# STATIONARY CIRCULAR SAW BLADES

## CONSTRUCTION CIRCULAR SAW BLADES

ITEM NO.	DESCRIPTION	CATEGORY	MACHINES	DIAMETER	TOOTH COUNT	ARBOR/BORE	KERF THICKNESS	TOOTH CONFIG.
1897395	Construction 216mm/24T M	Stationary	Mitre	216	24	30	2.0	ATB
1897396	Construction 216mm/48T M	Stationary	Mitre	216	48	30	2.0	ATB
1897397	Construction 216mm/60T M	Stationary	Mitre	216	60	30	2.0	ATB
1897398	Construction 250mm/48T M	Stationary	Mitre	250	48	30	2.8	ATB
1897426	Construction 250mm/60T M	Stationary	Mitre	250	60	30	2.8	ATB
1897427	Construction 250mm/80T M	Stationary	Mitre	250	80	30	2.8	ATB
1897428	Construction 254mm/48T M	Stationary	Mitre	254	48	30	2.8	ATB
1897429	Construction 254mm/60T M	Stationary	Mitre	254	60	30	2.8	ATB
1897430	Construction 254mm/80T M	Stationary	Mitre	254	80	30	2.8	ATB
1897431	Construction 260mm/48T M	Stationary	Mitre	260	48	30	2.8	ATB
1897432	Construction 260mm/60T M	Stationary	Mitre	260	60	30	2.8	ATB
1897433	Construction 260mm/80T M	Stationary	Mitre	260	80	30	2.8	ATB
1897434	Construction 305mm/48T M	Stationary	Mitre	305	48	30	3.2	ATB
1897435	Construction 305mm/60T M	Stationary	Mitre	305	60	30	3.2	ATB
1897436	Construction 305mm/80T M	Stationary	Mitre	305	96	30	3.2	ATB
1897448	Construction 250mm/24T	Stationary	Table & Mitre	250	24	30	3.2	ATB
1897449	Construction 250mm/40T	Stationary	Table & Mitre	250	40	30	3.2	ATB
1897450	Construction 250mm/60T	Stationary	Table & Mitre	250	60	30	3.2	ATB
1897451	Construction 300mm/48T	Stationary	Table & Mitre	300	48	30	3.2	ATB
1897452	Construction 300mm/60T	Stationary	Table & Mitre	300	60	30	3.2	ATB
1897437	MM CSB 160mm/48T	Multi	Handheld (corded)	160	48	20	2	TCG
1897438	MM CSB 165mm/48T	Multi	Handheld (corded)	165	48	30	2	TCG
1897439	MM CSB 184mm/48T	Multi	Handheld (corded)	184	48	30	2	TCG
1897440	MM CSB 190mm/48T	Multi	Handheld (corded)	190	48	30	2	TCG
1897441	MM CSB 210mm/84T	Multi	Handheld (corded)/Mitre	210	60	30	3	TCG
1897442	MM CSB 216mm/84T	Multi	Mitre	216	84	30	3	TCG
1897443	MM CSB 250mm/84T	Multi	Sliding Mitre/Mitre	250	84	30	3	TCG
1897444	MM CSB 254mm/84T	Multi	Sliding Mitre/Mitre	254	84	30	3	TCG
1897445	MM CSB 260mm/84T	Multi	Sliding Mitre/Mitre	260	84	30	3	TCG
1897446	MM CSB 300mm/96T	Multi	Table	300	96	30	3	TCG
1897447	MM CSB 305mm/84T	Multi	Sliding Mitre/Mitre	305	84	30	3	TCG

**CONSTRUCTION GRADE TUNGSTEN CARBIDE TIPS** for longer life and are resharpenable  
**#400 GRIT DIAMOND GROUND TEETH** for a smooth finish  
**EXPANSION SLOTS** to dissipate heat and prevent warping  
**THIN KERF** for fast cuts and longer motor life  
**CORROSION-RESISTANT COATING** for longer, quality performance  
**ALTERNATE TOP BEVEL TOOTH CONFIGURATION (ATB)** for cross cutting and ripping in all woods  
**TRIPLE CHIP GRIND TOOTH CONFIGURATION (TCG)** for cutting hard materials like laminates, MDF, plastics and non-ferrous metals



1897448

## GENERAL PURPOSE CIRCULAR SAW BLADES

ITEM NO.	DESCRIPTION	CATEGORY	MACHINES	DIAMETER	TOOTH COUNT	ARBOR/BORE	KERF THICKNESS	TOOTH CONFIG.
1897209	CSB 216mm/24T M	Stationary	Mitre	216	48	30	2.5	ATB
1897210	CSB 250mm/24T	Stationary	Table & Mitre	250	24	30	3.0	ATB
1897211	CSB 250mm/40T	Stationary	Table & Mitre	250	40	30	3.0	ATB
1907700	CSB 250mm/60T	Stationary	Table & Mitre	250	60	30	3.0	ATB
1897212	CSB 300mm/48T	Stationary	Table & Mitre	300	48	30	3.2	ATB
1897213	CSB 300mm/60T	Stationary	Table & Mitre	300	60	30	3.2	ATB
1897214	CSB 315mm/40T	Stationary	Table & Mitre	315	40	30	3.2	ATB
1897215	CSB 350mm/40T	Stationary	Table & Mitre	350	40	30	3.5	ATB
1897346	CSB 350mm/84T	Stationary	Table & Mitre	350	84	30	3.5	ATB
1897347	CSB 400mm/40T	Stationary	Table & Mitre	400	40	30	3.8	ATB
1897348	CSB 400mm/60T	Stationary	Table & Mitre	400	60	30	3.8	ATB

**BEST VALUE** for an economy blade  
**PRECISION GROUND TEETH** for smooth, accurate cuts  
**EXPANSION SLOTS** for straighter cuts  
**CORROSION-RESISTANT COATING** for longer, quality performance  
**ALTERNATE TOP BEVEL TOOTH CONFIGURATION (ATB)** for cross cutting and ripping in all woods



1907700

**IRWIN®**

**WELDTEC™**





# HAND-HELD & SPECIALITY CIRCULAR SAW BLADES

## WELDTEC CIRCULAR SAW BLADES



### WELDTEC CIRCULAR SAW BLADES



- 1. WELDED CARBIDE TEETH**  
Up to 30% stronger tooth bond and for 50% longer life
- 2. ULTRA-COMPACT (UC2) CARBIDE**  
70% tougher than standard carbide for superior sharpness and cut quality
- 3. INNOVATIVE HEAT VENTS & EXPANSION SLOTS**  
For straighter cuts
- 4. FULLY HARDENED PLATE & REINFORCED SHOULDER**  
For blade durability and truer, longer running with more accuracy
- 5. ALTERNATE TOP BEVEL (ATB) TOOTH CONFIGURATION**  
For cross cutting and ripping in all woods

SKU CODE	DESCRIPTION	CATEGORY	MACHINES	DIAMETER	TOOTH COUNT	ARBOR/BORE	REDUCTIONS	KERF THICKNESS	TOOTH CONFIG.
1897349	Weldtec CSB 150mm/24T	Handheld	Corded	150	24	20	16	2.4	ATB
1897350	Weldtec CSB 150mm/40T	Handheld	Corded	150	40	20	16	2.4	ATB
1897361	Weldtec CSB 160mm/18T	Handheld	Corded	160	18	20	16	2.4	ATB
1897362	Weldtec CSB 160mm/24T	Handheld	Corded	160	24	20	16	2.4	ATB
1897363	Weldtec CSB 160mm/40T	Handheld	Corded	160	40	20	16	2.4	ATB
1897364	Weldtec CSB 165mm/18T	Handheld	Corded	165	18	30	20	2.4	ATB
1897365	Weldtec CSB 165mm/24T	Handheld	Corded	165	24	30	20	2.4	ATB
1897366	Weldtec CSB 165mm/40T	Handheld	Corded	165	40	30	20	2.4	ATB
1897368	Weldtec CSB 184mm/24T AR30	Handheld	Corded	184	24	30	20	2.4	ATB
1897369	Weldtec CSB 184mm/24T AR16	Handheld	Corded	184	24	16	-	2.4	ATB
1897370	Weldtec CSB 184mm/40T AR30	Handheld	Corded	184	40	30	20	2.4	ATB
1897381	Weldtec CSB 184mm/40T AR16	Handheld	Corded	184	40	16	-	2.4	ATB
1897382	Weldtec CSB 190mm/18T	Handheld	Corded	190	18	30	20	2.4	ATB
1897383	Weldtec CSB 190mm/24T	Handheld	Corded	190	24	30	20	2.4	ATB
1897384	Weldtec CSB 190mm/40T	Handheld	Corded	190	40	30	20	2.4	ATB
1897385	Weldtec CSB 210mm/24T	Handheld	Corded	210	24	30	20	2.4	ATB
1897386	Weldtec CSB 210mm/40T	Handheld	Corded	210	40	30	20	2.4	ATB
1897387	Weldtec CSB 235mm/20T	Handheld	Corded	235	20	30	20	2.4	ATB
1897388	Weldtec CSB 235mm/40T	Handheld	Corded	235	40	30	20	2.4	ATB
1897389	Weldtec CSB 235mm/60T	Handheld	Corded	235	60	30	20	2.4	ATB
1897390	Weldtec CSB 136mm/18T C	Handheld	Cordless	136	18	10	-	1.8	ATB
1897391	Weldtec CSB 136mm/24T C	Handheld	Cordless	136	24	10	-	1.8	ATB
1897392	Weldtec CSB 165mm/18T C	Handheld	Cordless	165	18	20	16	1.8	ATB
1897393	Weldtec CSB 165mm/24T C	Handheld	Cordless	165	24	20	16	1.8	ATB
1897394	Weldtec CSB 165mm/40T C	Handheld	Cordless	165	40	20	16	1.8	ATB

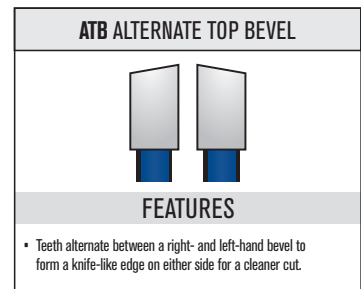



## HAND-HELD CONSTRUCTION

**THIN KERF WITH EVO ALTERNATING GRIND** for fast cutting speed  
**HEAT VENTS & EXPANSION SLOTS** reduce heat build-up and warping  
**CONSTRUCTION GRADE TUNGSTEN CARBIDE TIPS** retain their edge and deliver longer life  
**CORROSION-RESISTANT COATING** for longer, quality performance  
**ALTERNATE TOP BEVEL TOOTH CONFIGURATION (ATB)** for cross cutting and ripping in all woods



1897200

ITEM NO	DESCRIPTION	CATEGORY	MACHINES	DIAMETER	TOOTH COUNT	ARBOR/BORE	KERF THICKNESS	TOOTH CONFIG.
1897086	125mm/16T	Handheld	Corded	125	16	20	2.5	ATB
1897087	130mm/20T	Handheld	Corded	130	20	20	2.5	ATB
1897088	140mm/20T	Handheld	Corded	140	20	20	2.5	ATB
1897089	150mm/18T	Handheld	Corded	150	18	20	2.5	ATB
1897090	150mm/30T	Handheld	Corded	150	30	20	2.5	ATB
1897191	160mm/18T	Handheld	Corded	160	18	20	2.5	ATB
1897192	160mm/30T	Handheld	Corded	160	30	20	2.5	ATB
1907698	160mm/24T	Handheld	Corded	160	24	30	2.5	ATB
1897193	165mm/18T	Handheld	Corded	165	18	30	2.5	ATB
1897194	165mm/30T	Handheld	Corded	165	30	30	2.5	ATB
1897195	180mm/24T	Handheld	Corded	180	24	30	2.5	ATB
1897196	180mm/36T	Handheld	Corded	180	36	30	2.5	ATB
1907699	184mm/24T	Handheld	Corded	184	24	16	2.5	ATB
1897197	184mm/24T	Handheld	Corded	184	24	30	2.5	ATB
1897198	184mm/40T	Handheld	Corded	184	40	30	2.5	ATB
1897199	190mm/24T	Handheld	Corded	190	24	30	2.5	ATB
1897200	190mm/40T	Handheld	Corded	190	40	30	2.5	ATB
1897201	200mm/24T	Handheld	Corded	200	24	30	2.5	ATB
1897202	200mm/40T	Handheld	Corded	200	40	30	2.5	ATB
1897203	210mm/20T	Handheld	Corded	210	20	30	2.5	ATB
1897204	210mm/40T	Handheld	Corded	210	40	30	2.5	ATB
1897205	230mm/24T	Handheld	Corded	230	24	30	2.8	ATB
1897206	230mm/40T	Handheld	Corded	230	40	30	2.8	ATB
1897207	235mm/20T	Handheld	Corded	235	20	30	2.8	ATB
1897208	235mm/40T	Handheld	Corded	235	40	30	2.8	ATB

## SPECIALITY BLADES FOR NON-FERROUS METAL

**EXPANSION SLOTS** help keep the blade flat  
**TRIPLE CHIP GROUND TOOTH (TCG)** for excellent finish of the cut  
**SPECIALLY DESIGNED** for cutting all types of non-ferrous metals such as aluminium, copper, lead and plastics



1907778

ITEM NO	DESCRIPTION	CATEGORY	MACHINES	DIAMETER	TOOTH COUNT	ARBOR/BORE	KERF THICKNESS	TOOTH CONFIG.
1907772	Aluminium 160 x 56 x 20	Speciality	Speciality	160	56	20	2.5	TCG
1907773	Aluminium 184 x 48 x 30	Speciality	Speciality	184	48	30	2.5	TCG
1907774	Aluminium 200 x 60 x 30	Speciality	Speciality	200	60	30	2.5	TCG
1907775	Aluminium 210 x 60 x 30	Speciality	Speciality	210	60	30	2.5	TCG
1907777	Aluminium 216 x 60 x 30	Speciality	Speciality	216	60	30	2.5	TCG
1907778	Aluminium 250 x 80 x 30	Speciality	Speciality	250	80	30	2.5	TCG
1907779	Aluminium 250 x 100 x 30	Speciality	Speciality	250	100	30	2.5	TCG
1907781	Aluminium 300 x 96 x 30	Speciality	Speciality	300	96	30	2.5	TCG
1907782	Aluminium 350 x 84 x 30	Speciality	Speciality	350	84	30	2.5	TCG

# CIRCULAR SAW BLADES

## SELECTION CHART

	DIAMETER	TOOTH	BORE	BLADE	SKU	HARDWOODS	SOFTWOODS	NAIL EMBEDDED	PLYWOOD	LAMINATED PLYWOOD	PARTICLE BOARD	DELICATE MOULDING	LAMINATES	BILAMINATE PANELS (DOUBLE-SIDED LAMINATES)	CONGLOMERATES (COMPOSITES)	MDF	MELAMINE	NON-FERROUS METALS (ALUMINUM)	PLASTICS	CORIAN	
HANDHELD CORDED	150mm	24T	20mm	WELDTEC	1897349	5	5	5	5	3	5	2	3	3	4	4	2	N/A	4	2	
	150mm	30T	20mm	IRWIN®	1897090	4	4	2	4	2	4	1	2	2	3	3	1	N/A	3	1	
	150mm	40T	20mm	WELDTEC	1897350	5	5	5	5	3	5	2	3	3	4	4	2	N/A	4	2	
	160mm	18T	20mm	IRWIN®	1897191	4	4	2	4	2	4	N/A	2	2	3	3	1	N/A	3	1	
				WELDTEC	1897361	5	5	5	5	3	5	2	3	3	4	4	2	N/A	4	2	
	160mm	24T	30mm	IRWIN®	1907698	4	4	4	4	2	4	1	2	2	3	3	1	N/A	3	1	
				WELDTEC	1897362	5	5	5	5	3	5	2	3	3	4	4	2	N/A	4	2	
	160mm	30T	20mm	IRWIN®	1897192	4	4	2	4	2	4	1	2	2	3	3	1	N/A	3	1	
	160mm	40T	20mm	WELDTEC	1897363	5	5	5	5	3	5	2	3	3	4	4	2	N/A	4	2	
	165mm	18T	30mm	IRWIN®	1897193	4	4	2	4	2	4	N/A	2	2	3	3	1	N/A	3	1	
				WELDTEC	1897364	5	5	5	5	3	5	2	3	3	4	4	2	N/A	4	2	
	165mm	30T	30mm	IRWIN®	1897194	4	4	2	4	2	4	1	2	2	3	3	1	N/A	3	1	
	165mm	40T	30mm	WELDTEC	1897366	5	5	5	5	3	5	2	3	3	4	4	2	N/A	4	2	
	180mm	24T	30mm	IRWIN®	1897195	4	4	2	4	2	4	N/A	2	2	3	3	1	N/A	3	1	
	180mm	36T	30mm	IRWIN®	1897196	4	4	2	4	2	4	1	2	2	3	3	1	N/A	3	1	
	184mm	24T	16mm	IRWIN®	1907699	4	4	2	4	2	4	N/A	2	2	3	3	1	N/A	3	1	
				WELDTEC	1897369	5	5	5	5	3	5	2	3	3	4	4	2	N/A	4	2	
	184mm	24T	30mm	IRWIN®	1897197	4	4	2	4	2	4	N/A	2	2	3	3	1	N/A	3	1	
				WELDTEC	1897368	5	5	5	5	3	5	2	3	3	4	4	2	N/A	4	2	
	184mm	40T	16mm	WELDTEC	1897381	5	5	5	5	3	5	2	3	3	4	4	2	N/A	4	2	
	184mm	40T	30mm	IRWIN®	1897198	4	4	2	4	2	4	1	2	2	3	3	1	N/A	3	1	
				WELDTEC	1897370	5	5	5	5	3	5	2	3	3	4	4	2	N/A	4	2	
	190mm	18T	30mm	WELDTEC	1897382	5	5	5	5	3	5	2	3	3	4	4	2	N/A	4	2	
	190mm	24T	30mm	IRWIN®	1897199	4	4	2	4	2	4	1	2	2	3	3	1	N/A	3	1	
				WELDTEC	1897383	5	5	5	5	3	5	2	3	3	4	4	2	N/A	4	2	
	190mm	40T	30mm	IRWIN®	1897200	4	4	2	4	2	4	1	2	2	3	3	1	N/A	3	1	
				WELDTEC	1897384	5	5	5	5	3	5	2	3	3	4	4	2	N/A	4	2	
	200mm	24T	30mm	IRWIN®	1897201	4	4	2	4	2	4	N/A	2	2	3	3	1	N/A	3	1	
	200mm	40T	30mm	IRWIN®	1897202	4	4	2	4	2	4	1	2	2	3	3	1	N/A	3	1	
	210mm	20T	30mm	IRWIN®	1897203	4	4	2	4	2	4	N/A	2	2	3	3	1	N/A	3	1	
	210mm	24T	30mm	WELDTEC	1897385	5	5	5	5	3	5	2	3	3	4	4	2	N/A	4	2	
	210mm	40T	30mm	IRWIN®	1897204	4	4	2	4	2	4	1	2	2	3	3	1	N/A	3	1	
				WELDTEC	1897386	5	5	5	5	3	5	2	3	3	4	4	2	N/A	4	2	
	235mm	20T	30mm	WELDTEC	1897387	5	5	5	5	3	5	2	3	3	4	4	2	N/A	4	2	
	230mm	24T	30mm	IRWIN®	1897205	4	4	2	4	2	4	N/A	2	2	3	3	1	N/A	3	1	
	230mm	40T	30mm	IRWIN®	1897206	4	4	2	4	2	4	1	2	2	3	3	1	N/A	3	1	
				WELDTEC	1897388	5	5	5	5	3	5	2	3	3	4	4	2	N/A	4	2	
	235mm	40T	30mm	WELDTEC	1897389	5	5	5	5	3	5	2	3	3	4	4	2	N/A	4	2	
	CORDLESS	136mm	18T	10mm	WELDTEC	1897390	5	5	5	5	3	5	2	3	3	4	4	2	N/A	4	2
		136mm	24T	10mm	WELDTEC	1897391	5	5	5	5	3	5	2	3	3	4	4	2	N/A	4	2
165mm		18T	20mm	WELDTEC	1897392	5	5	5	5	3	5	2	3	3	4	4	2	N/A	4	2	
165mm		24T	20mm	WELDTEC	1897393	5	5	5	5	3	5	2	3	3	4	4	2	N/A	4	2	
165mm	40T	20mm	WELDTEC	1897394	5	5	5	5	3	5	2	3	3	4	4	2	N/A	4	2		

RATING SCALE: (1=FAIR, 3=GOOD, 5=BEST)



## SELECTION CHART

	DIAMETER	TOOTH	BORE	BLADE	SKU	HARDWOODS	SOFTWOODS	NAIL EMBEDDED	PLYWOOD	LAMINATED PLYWOOD	PARTICLE BOARD	DELICATE MOULDING	LAMINATES	BILAMINATE PANELS (DOUBLE-SIDED LAMINATES)	CONGLOMERATES (COMPOSITES)	MDF	MELAMINE	NON-FERROUS METALS (ALUMINUM)	PLASTICS	CORIAN	TABLE	
																					STATIONARY	
	235mm	20T	30mm	IRWIN®	1897207	4	4	2	4	2	4	N/A	2	2	3	3	1	N/A	3	1		
	235mm	40T	30mm	IRWIN®	1897208	4	4	2	4	2	4	1	2	2	3	3	1	N/A	3	1		
	250mm	24T	30mm	IRWIN®	1897210	4	4	2	4	2	4	N/A	2	2	3	3	1	N/A	3	3		
				Construction	1897448	5	5	2	5	2	5	2	5	2	2	2	4	4	1	N/A	3	3
				MARPLES®	1897474	5	5	2	5	2	5	N/A	2	2	4	4	1	N/A	3	3		
	250mm	40T	30mm	IRWIN®	1897211	4	4	2	4	2	4	N/A	2	2	3	3	1	N/A	3	3		
				Construction	1897449	5	5	2	5	2	5	3	2	2	2	4	4	1	N/A	3	3	
				MARPLES®	1897475	5	5	2	5	2	5	3	2	2	2	4	4	1	N/A	3	3	
	250mm	60T	30mm	IRWIN®	1907700	3	3	1	3	1	3	3	1	1	3	3	N/A	N/A	2	2		
				Construction	1897450	4	4	2	4	2	4	4	2	2	2	4	4	1	N/A	3	3	
				MARPLES®	1897476	5	5	2	5	2	5	4	2	2	4	4	1	N/A	3	3		
	250mm	80T	30mm	MARPLES®	1897477	5	5	2	5	2	5	5	2	2	4	4	1	N/A	3	3		
	300mm	24T	30mm	MARPLES®	1897478	5	5	2	5	2	5	N/A	2	2	4	4	1	N/A	3	3		
	300mm	48T	30mm	IRWIN®	1897212	4	4	2	4	2	4	N/A	2	2	3	3	1	N/A	3	3		
				Construction	1897451	5	5	2	5	2	5	3	2	2	2	4	4	1	N/A	3	3	
				MARPLES®	1897479	5	5	2	5	2	5	3	2	2	2	4	4	1	N/A	3	3	
	300mm	60T	30mm	IRWIN®	1897213	4	4	2	4	2	4	N/A	2	2	3	3	1	N/A	3	3		
				Construction	1897452	5	5	2	5	2	5	4	2	2	2	4	4	1	N/A	3	3	
				MARPLES®	1897480	5	5	2	5	2	5	4	2	2	2	4	4	1	N/A	3	3	
	315mm	40T	30mm	IRWIN®	1897214	4	4	2	4	2	4	N/A	2	2	3	3	1	N/A	3	3		
	350mm	40T	30mm	IRWIN®	1897215	4	4	2	4	2	4	N/A	2	2	3	3	1	N/A	3	3		
	350mm	84T	30mm	IRWIN®	1897346	4	4	2	4	2	4	N/A	2	2	3	3	1	N/A	3	3		
	400mm	40T	30mm	IRWIN®	1897347	4	4	2	4	2	4	N/A	2	2	3	3	1	N/A	3	3		
	400mm	60T	30mm	IRWIN®	1897348	4	4	2	4	2	4	N/A	2	2	4	4	1	N/A	3	3		
	216mm	24T	30mm	Construction	1897395	5	5	1	5	3	4	1	3	2	4	4	2	N/A	4	2		
				MARPLES®	1897453	5	5	1	5	3	4	1	3	2	2	4	5	2	N/A	4	2	
				IRWIN®	1897209	4	4	2	4	2	3	1	2	2	3	3	1	N/A	3	1		
	216mm	48T	30mm	Construction	1897396	5	5	1	5	3	4	3	3	2	4	4	2	N/A	4	2		
				MARPLES®	1897454	5	5	1	5	3	4	4	3	2	2	4	5	2	N/A	4	2	
	216mm	60T	30mm	Construction	1897397	5	5	1	5	3	4	4	3	2	4	4	2	N/A	4	2		
				MARPLES®	1897455	5	5	1	5	3	4	5	3	2	2	4	5	2	N/A	4	2	
	250mm	48T	30mm	Construction	1897398	5	5	1	5	3	4	2	3	2	4	4	2	N/A	4	2		
				MARPLES®	1897456	5	5	1	5	3	4	3	3	2	2	4	5	2	N/A	4	2	
	250mm	60T	30mm	Construction	1897426	5	5	1	5	3	4	3	3	2	4	4	2	N/A	4	2		
				MARPLES®	1897457	5	5	1	5	3	4	4	3	2	2	4	5	2	N/A	4	2	
	250mm	80T	30mm	Construction	1897427	5	5	1	5	3	4	4	3	2	4	4	2	N/A	4	2		
				MARPLES®	1897458	5	5	1	5	3	4	5	3	2	2	4	5	2	N/A	4	2	
	254mm	48T	30mm	Construction	1897428	5	5	1	5	3	4	2	3	2	4	4	2	N/A	4	2		
				MARPLES®	1897459	5	5	1	5	3	4	3	3	2	2	4	5	2	N/A	4	2	
	254mm	60T	30mm	Construction	1897429	5	5	1	5	3	4	3	3	2	4	4	2	N/A	4	2		
				MARPLES®	1897460	5	5	1	5	3	4	4	3	2	2	4	5	2	N/A	4	2	
	254mm	80T	30mm	Construction	1897430	5	5	1	5	3	4	4	3	2	4	4	2	N/A	4	2		
				MARPLES®	1897461	5	5	1	5	3	4	5	3	2	2	4	5	2	N/A	4	2	
	260mm	48T	30mm	Construction	1897431	5	5	1	5	3	4	2	3	2	4	4	2	N/A	4	2		
				MARPLES®	1897462	5	5	1	5	3	4	3	3	2	2	4	5	2	N/A	4	2	
	260mm	60T	30mm	Construction	1897432	5	5	1	5	3	4	3	3	2	4	4	2	N/A	4	2		
				MARPLES®	1897463	5	5	1	5	3	4	3	3	2	2	4	5	2	N/A	4	2	
	260mm	80T	30mm	Construction	1897433	5	5	1	5	3	4	4	3	2	4	4	2	N/A	4	2		
				MARPLES®	1897464	5	5	1	5	3	4	4	3	2	2	4	5	2	N/A	4	2	
	305mm	48T	30mm	Construction	1897434	5	5	1	5	3	4	2	3	2	4	4	2	N/A	4	2		
				MARPLES®	1897465	5	5	1	5	3	4	3	3	2	2	4	5	2	N/A	4	2	
	305mm	60T	30mm	Construction	1897435	5	5	1	5	3	4	3	3	2	4	4	2	N/A	4	2		
				MARPLES®	1897466	5	5	1	5	3	4	4	3	2	2	4	5	2	N/A	4	2	
	305mm	96T	30mm	Construction	1897436	5	5	1	5	3	4	4	3	2	4	4	2	N/A	4	2		
				MARPLES®	1897467	5	5	1	5	3	4	5	3	2	2	4	5	2	N/A	4	2	



# CIRCULAR SAW BLADES

## SELECTION CHART

		DIAMETER	TOOTH	BORE	BLADE	SKU	HARDWOODS	SOFTWOODS	NAIL EMBEDDED	PLYWOOD	LAMINATED PLYWOOD	PARTICLE BOARD	DELICATE MOULDING	LAMINATES	BILAMINATE PANELS (DOUBLE-SIDED LAMINATES)	CONGLOMERATES (COMPOSITES)	MDF	MELAMINE	NON-FERROUS METALS (ALUMINIUM)	PLASTICS	CORIAN		
STATIONARY	MULTI	160mm	48T	20mm	Construction	1897437	4	3	2	3	4	3	5	5	4	4	4	5	4	4	5		
		165mm	48T	30mm	Construction	1897438	4	3	2	3	4	3	5	5	4	4	4	4	5	4	4	5	
		184mm	48T	30mm	Construction	1897439	4	3	2	3	4	3	5	5	4	4	4	4	5	4	4	5	
		190mm	48T	30mm	Construction	1897440	4	3	2	3	4	3	5	5	4	4	4	4	5	4	4	5	
		210mm	60T	30mm	Construction	1897441	4	3	2	3	4	3	5	5	4	4	4	4	5	4	4	5	
		216mm	84T	30mm	Construction	1897442	4	3	2	3	4	3	5	5	4	4	4	4	4	5	4	4	5
					MARPLES®	1897468	4	3	2	3	4	3	5	5	4	4	4	4	4	5	4	4	5
		250mm	84T	30mm	Construction	1897443	4	3	2	3	4	3	5	5	4	4	4	4	4	5	4	4	5
					MARPLES®	1897469	4	3	2	3	4	3	5	5	4	4	4	4	4	5	4	4	5
		254mm	84T	30mm	Construction	1897444	4	3	2	3	4	3	5	5	4	4	4	4	4	5	4	4	5
					MARPLES®	1897470	4	3	2	3	4	3	5	5	4	4	4	4	4	5	4	4	5
		260mm	84T	30mm	Construction	1897445	4	3	2	3	4	3	5	5	4	4	4	4	4	5	4	4	5
					MARPLES®	1897471	4	3	2	3	4	3	5	5	4	4	4	4	4	5	4	4	5
		300mm	96T	30mm	Construction	1897446	4	3	2	3	4	3	5	5	4	4	4	4	4	5	4	4	5
					MARPLES®	1897472	4	3	2	3	4	3	5	5	4	4	4	4	4	5	4	4	5
		305mm	84T	30mm	Construction	1897447	4	3	2	3	4	3	5	5	4	4	4	4	4	5	4	4	5
MARPLES®	1897473				4	3	2	3	4	3	5	5	4	4	4	4	4	5	4	4	5		
MATERIAL SPECIFIC	ALUMINIUM	160mm	56T	20mm	IRWIN®	1907772	N/A	N/A	N/A	N/A	N/A	N/A	N/A	N/A	N/A	N/A	N/A	N/A	5	N/A	N/A		
		184mm	48T	30mm	IRWIN®	1907773	N/A	N/A	N/A	N/A	N/A	N/A	N/A	N/A	N/A	N/A	N/A	N/A	N/A	5	N/A	N/A	
		200mm	60T	30mm	IRWIN®	1907774	N/A	N/A	N/A	N/A	N/A	N/A	N/A	N/A	N/A	N/A	N/A	N/A	N/A	5	N/A	N/A	
		210mm	60T	30mm	IRWIN®	1907775	N/A	N/A	N/A	N/A	N/A	N/A	N/A	N/A	N/A	N/A	N/A	N/A	N/A	N/A	5	N/A	N/A
		216mm	60T	30mm	IRWIN®	1907777	N/A	N/A	N/A	N/A	N/A	N/A	N/A	N/A	N/A	N/A	N/A	N/A	N/A	N/A	5	N/A	N/A
		250mm	80T	30mm	IRWIN®	1907778	N/A	N/A	N/A	N/A	N/A	N/A	N/A	N/A	N/A	N/A	N/A	N/A	N/A	N/A	5	N/A	N/A
		250mm	100T	30mm	IRWIN®	1907779	N/A	N/A	N/A	N/A	N/A	N/A	N/A	N/A	N/A	N/A	N/A	N/A	N/A	N/A	5	N/A	N/A
		300mm	96T	30mm	IRWIN®	1907781	N/A	N/A	N/A	N/A	N/A	N/A	N/A	N/A	N/A	N/A	N/A	N/A	N/A	N/A	5	N/A	N/A
		250mm	84T	30mm	IRWIN®	1907782	N/A	N/A	N/A	N/A	N/A	N/A	N/A	N/A	N/A	N/A	N/A	N/A	N/A	N/A	5	N/A	N/A

RATING SCALE: (1=FAIR, 3=GOOD, 5=BEST)

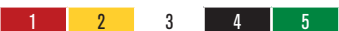

**IRWIN®**





## LONG ESTABLISHED MANUFACTURING EXCELLENCE LEADS TO PERFECTION

IRWIN® manufactures and distributes high quality cutting tools for trade professionals who demand superior performance and durability on the job. Our engineers have been working for almost over a century on constant product improvement, resulting in a state-of-the-art in-house electron beam welding process to create the highest quality bi-metal blades that out-perform the competition, stay sharper and last longer.

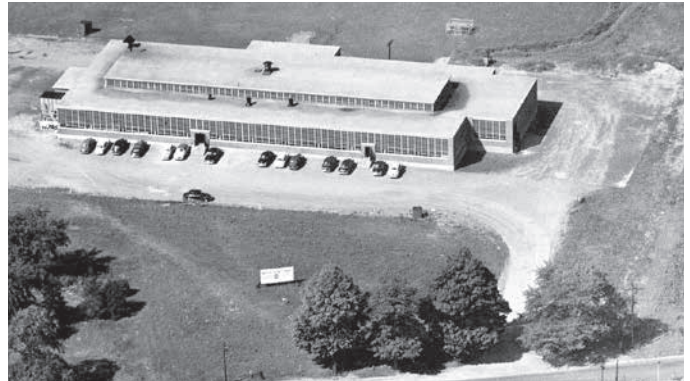

WITH **WELDTec™**

The WeldTec™ platform combines various attributes to deliver long lasting cutting performance. A revolutionary tooth geometry and an updated tooth set enables faster and smoother cuts, as well as improved longevity.

### HOLE SAWS



### RECIPROCATING BLADES



### JIGSAW BLADES





## BI-METAL HOLE SAWS

IRWIN® Bi-Metal Hole Saws cut through a variety of materials, including: Aluminium, Copper, Iron, Stainless Steel, Wood and Zinc.

The electron beam welded High Speed Steel (HSS) cutting edge ensures stronger, longer lasting teeth. Precision set teeth provide faster penetration and cutting. And, the bi-metal construction delivers toughness and long life.

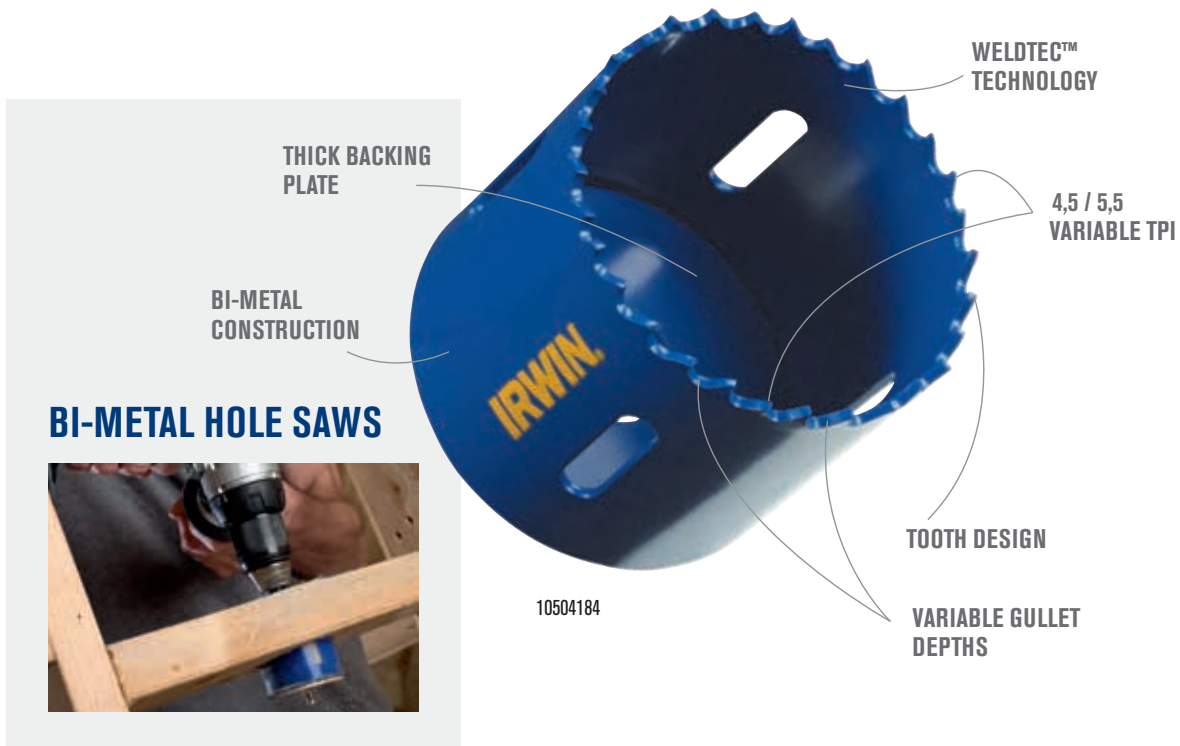

### BI-METAL HOLE SAWS



1. **WELDTEC™ TECHNOLOGY**  
Delivers enhanced durability and higher cutting speed
2. **TOOTH DESIGN**  
For up to 100% longer life and 50% faster cutting\*
3. **4,5 / 5,5 VARIABLE TPI**  
For faster cuts, less torque build-up and enhanced chip removal
4. **VARIABLE GULLET DEPTHS**  
For more efficient chip clearance
5. **THICK BACKING PLATE**  
Gives robustness for the toughest jobs
6. **BI-METAL CONSTRUCTION**  
For increased life and durability

\*vs. previous model

ITEM NO.	HOLE SAW DIAMETER	EAN	MASTER PACK	SHELF PACK
10504161	Ø 14mm	5706915041613	160	1
10504162	Ø 16mm	5706915041620	160	1
10504163	Ø 17mm	5706915041637	160	1
10504164	Ø 19mm	5706915041644	160	1
10504165	Ø 20mm	5706915041651	160	1
10504166	Ø 21mm	5706915041668	160	1
10504167	Ø 22mm	5706915041675	160	1
10504168	Ø 24mm	5706915041682	160	1
10504169	Ø 25mm	5706915041699	160	1
10504170	Ø 27mm	5706915041705	160	1
10504171	Ø 29mm	5706915041712	160	1
10504172	Ø 30mm	5706915041729	160	1
10504173	Ø 32mm	5706915041736	120	1
10504174	Ø 33mm	5706915041743	120	1
10504175	Ø 35mm	5706915041750	120	1
10504176	Ø 37mm	5706915041767	120	1
10504177	Ø 38mm	5706915041774	120	1
10504178	Ø 40mm	5706915041781	120	1
10504179	Ø 41mm	5706915041798	120	1
10504180	Ø 43mm	5706915041804	120	1
10504181	Ø 44mm	5706915041811	120	1

# BI-METAL HOLE SAWS

## BI-METAL HOLE SAWS

ITEM NO.	HOLE SAW DIAMETER	EAN	MASTER PACK	SHELF PACK
10504182	Ø 46mm	5706915041828	120	1
10504183	Ø 48mm	5706915041835	100	1
10504184	Ø 51mm	5706915041842	100	1
10504185	Ø 52mm	5706915041859	100	1
10504186	Ø 54mm	5706915041866	100	1
10507366	Ø 56mm	5706915073669	100	1
10504187	Ø 57mm	5706915041873	100	1
10504188	Ø 59mm	5706915041880	100	1
10504189	Ø 60mm	5706915041897	100	1
10507367	Ø 62mm	5706915073676	100	1
10504190	Ø 64mm	5706915041903	50	1
10504191	Ø 65mm	5706915041910	50	1
10504192	Ø 67mm	5706915041927	50	1
10504193	Ø 68mm	5706915041934	50	1
10504194	Ø 70mm	5706915041941	50	1
10504195	Ø 73mm	5706915041958	50	1
10504196	Ø 76mm	5706915041965	50	1
10504197	Ø 79mm	5706915041972	50	1
10504198	Ø 83mm	5706915041989	50	1
10504199	Ø 86mm	5706915041996	50	1
10504200	Ø 89mm	5706915042009	50	1
10504201	Ø 92mm	5706915042016	40	1
10504202	Ø 95mm	5706915042023	40	1
10504203	Ø 98mm	5706915042030	40	1
10504204	Ø 102mm	5706915042047	40	1
10504205	Ø 105mm	5706915042054	40	1
10504206	Ø 108mm	5706915042061	40	1
10504207	Ø 111mm	5706915042078	40	1
10504208	Ø 114mm	5706915042085	40	1
10504209	Ø 117mm	5706915042092	20	1
10504210	Ø 121mm	5706915042108	20	1
10504211	Ø 127mm	5706915042115	20	1
10505818	Ø 133mm	5706915058185	20	1
10504212	Ø 140mm	5706915042122	20	1
10504213	Ø 152mm	5706915042139	20	1
10505819	Ø 168mm	5706915058192	20	1
10505820	Ø 177mm	5706915058208	20	1
10505821	Ø 210mm	5706915058215	20	1



10504184

## ARBORS / PILOT DRILL BITS FOR BI-METAL HOLE SAW KITS

ITEM NO.	DESCRIPTION	EAN	MASTER PACK	SHELF PACK
10504532	Pilot Drill	5706915945324	20	1
10504536	Arbor (Mandrel) 9,5mm chuck diameter, fits Hole Saws 14 - 30mm	5706915945362	20	1
10504533	Arbor (Mandrel) 13mm chuck diameter, fits Hole Saws 14 - 30mm	5706915945331	20	1
10504534	Arbor (Mandrel) 9,5mm chuck diameter, fits Hole Saws 32 - 210mm	5706915945348	20	1
10504535	Arbor (Mandrel) 13mm chuck diameter, fits Hole Saws 32 - 210mm	5706915945355	20	1
10507368	Extension Rod, 300mm, Chuck size 13+mm	5706915073683	20	1



10504535

## BI-METAL HOLE SAW KITS

IRWIN® Hole Saw Kits are available in a unique attractive soft storage case that incorporates an unbreakable hinge and internal padding that protects the contents. The case has an integrated handle and has a cardboard sleeve that contains important product information.

ITEM NO.	DESCRIPTION	EAN	MASTER PACK	SHELF PACK
10507235	Hole Saw Kit 400SE: 22, 35, 65, 67mm, Arbors 10504535 & 10504536, Pilot drill	5706915072358	144	1
10506439	Hole Saw Kit 600L: 22, 29, 35, 44, 51, 64mm, Arbors 10504535 & 10504536, Pilot drill	5706915064391	144	1
10506440	Hole Saw Kit 600L SE: 22, 29, 35, 44, 51, 65mm, Arbors 10504535 & 10504536, Pilot drill	5706915064407	144	1
10506441	Hole Saw Kit INT600L: 16, 20, 25, 32, 38, 51mm, Arbors 10504535 & 10504536, Pilot drill	5706915064414	144	1
10506442	Hole Saw Kit 600P: 19, 22, 29, 38, 44, 57mm, Arbors 10504535 & 10504536, Pilot drill	5706915064421	144	1
10506444	Hole Saw Kit 1200G: 16, 19, 22, 25, 29, 32, 35, 38, 44, 51, 64, 76mm, Arbors 10504533 & 10504535, 3 Pilot drills	5706915064445	96	1
10506445	Hole Saw Kit 1200G SE: 16, 19, 22, 25, 29, 32, 35, 38, 44, 51, 65, 76mm, Arbors 10504533 & 10504535, 3 Pilot drills	5706915064452	96	1



10507235



**IRWIN®**





# RECIPROCATING SAW BLADES

## BI-METAL RECIPROCATING BLADES

This comprehensive reciprocating saw blade offering has a blade for every application. IRWIN® blades offer superior construction and design making them faster cutting and longer lasting, therefore giving the user a superior cost-per-cut value.

**BI-METAL RECIP BLADES**

- 1. INCREASED TANG ANGLE**  
For up to 50% faster cuts vs. previous model
- 2. BI-METAL CONSTRUCTION**  
For a faster cutting, longer lasting blade that can bend without breaking
- 3. WELDTEC™ TECHNOLOGY**  
For stronger, longer lasting teeth
- 4. 8% COBALT**  
Keeps teeth sharper, longer
- 5. IMPROVED TOOTH CONFIGURATION**  
For up to 100% longer life and 50% faster cutting\*

LONG-LASTING  
**BiMetal**  
TECHNOLOGY

WITH **WELDTEC™**

### METAL CUTTING BI-METAL RECIPROCATING SAW BLADES

ITEM NO.	DESCRIPTION	BLADES PER PACK	EAN	MASTER PACK	SHELF PACK	<b>CUTS ALL METALS</b> including non ferrous, pipe conduit, stainless & sheet metal <b>SUITABLE</b> for use with materials 1.5 to 10mm (1/16" to 3/8") thick, dependent on the TPI of the blade <b>AVAILABLE IN</b> 10, 14, 18 and 24TPI on metal cutting reciprocating saws
10506424	614R 6" / 150mm 14TPI, Metal Cutting	2	5706915064247	150	1	
10506425	624R 6" / 150mm 24TPI, Metal Cutting	2	5706915064254	150	1	
10506426	818R 8" / 200mm 18TPI, Metal Cutting	2	5706915064261	90	1	
10504147	414R 4" / 100mm 14TPI, Metal Cutting	5	5706915041477	100	1	
10504148	418R 4" / 100mm 18TPI, Metal Cutting	5	5706915041484	100	1	
10504152	614R 6" / 150mm 14TPI, Metal Cutting	5	5706915041521	100	1	
10504153	618R 6" / 150mm 18TPI, Metal Cutting	5	5706915041538	100	1	
10504154	624R 6" / 150mm 24TPI, Metal Cutting	5	5706915041545	100	1	
10504156	818R 8" / 200mm 18TPI, Metal Cutting	5	5706915041569	50	1	
10504143	614R 6" / 150mm 14TPI, Metal Cutting	25	5706915041439	20	1	
10504140	818R 8" / 200mm 18TPI, Metal Cutting	25	5706915041408	10	1	



## METAL & WOOD CUTTING BI-METAL RECIPROCATING BLADES



CUTS COMPOSITION MATERIALS such as plastic, wood, pipe, carbon steel & stainless steel SUITABLE for use with materials 3.2mm (1/8") & thicker AVAILABLE IN 10 TPI in 150, 200 & 300mm (6", 8" & 12") sizes	ITEM NO.	DESCRIPTION	BLADES PER PACK	EAN	MASTER PACK	SHELF PACK
		10506427	610R 6" / 150mm 10TPI, Metal & Wood Cutting	2	5706915064278	150
	10506428	810R 8" / 200mm 10TPI, Metal & Wood Cutting	2	5706915064285	90	1
	10504151	610R 6" / 150mm 10TPI, Metal & Wood Cutting	5	5706915041514	100	1
	10504157	810R 8" / 200mm 10TPI, Metal & Wood Cutting	5	5706915041576	50	1
	10504159	110R 12" / 300mm 10TPI, Metal & Wood Cutting	5	5706915041590	50	1
	10504141	810R 8" / 200mm 10TPI, Metal & Wood Cutting	25	5706915041415	10	1
	10504142	110R 12" / 300mm 10TPI, Metal & Wood Cutting	25	5706915041422	25	1

## NAIL-EMBEDDED BI-METAL RECIPROCATING BLADES



CUTS NAIL EMBEDDED WOOD SUITABLE for use with materials 5mm (3/16") & thicker AVAILABLE IN 6TPI in 150, 225 & 300mm (6", 9" & 12") sizes	ITEM NO.	DESCRIPTION	BLADES PER PACK	EAN	MASTER PACK	SHELF PACK
		10506429	656R 6" / 150mm 6TPI, Nail-Embedded Wood Cutting	2	5706915064292	150
	10506430	956R 9" / 225mm 6TPI, Nail-Embedded Wood Cutting	2	5706915064308	90	1
	10504155	656R 6" / 150mm 6TPI, Nail-Embedded Wood Cutting	5	5706915041552	100	1
	10504158	956R 9" / 225mm 6TPI, Nail-Embedded Wood Cutting	5	5706915041583	50	1
	10504160	156R 12" / 300mm 6TPI, Nail-Embedded Wood Cutting	5	5706915041606	50	1
	10504146	656R 6" / 150mm 6TPI, Nail-Embedded Wood Cutting	25	5706915041460	20	1
	10504149	956R 9" / 225mm 6TPI, Nail-Embedded Wood Cutting	25	5706915041491	10	1
	10504144	156R 12" / 300mm 6TPI, Nail-Embedded Wood Cutting	25	5706915041446	10	1

## DEMOLITION BI-METAL RECIPROCATING BLADES



HEAVY-DUTY & DEMOLITION applications in wood & metal SUITABLE for use with materials 5mm (3/16") & thicker AVAILABLE IN 6 or 10 TPI in 225mm (9")	ITEM NO.	DESCRIPTION	BLADES PER PACK	EAN	MASTER PACK	SHELF PACK
		10504138	966R 9" / 225mm 6TPI, Demolition Applications	5	5706915041385	50
	10504139	960R 9" / 225mm 10TPI, Demolition Applications	5	5706915041392	50	1

## WOOD CUTTING BI-METAL RECIPROCATING BLADES



FAST CUTTING in wood SUITABLE for use with materials 5mm (3/16") & thicker AVAILABLE IN 6 TPI in 150mm (6")	ITEM NO.	DESCRIPTION	BLADES PER PACK	EAN	MASTER PACK	SHELF PACK
		10504150	606R 6" / 150mm 6TPI, Wood Cutting	5	5706915041507	100

# RECIPROCATING SAW BLADES

## MASTER-GRIT RECIPROCATING BLADES



ITEM NO.	DESCRIPTION	BLADES PER PACK	EAN	MASTER PACK	SHELF PACK
10507365	80ORG 8" / 200mm Carbide Grit	2	5706915073652	80	1

**CARBIDE GRIT EDGE MATERIAL** for smooth, quick cuts  
**CUTS ABRASIVE MATERIALS** including cast iron, fiberglass, plaster and marble

## WOOD, COMPOSITION MATERIAL & PLASTIC CUTTING HCS RECIPROCATING BLADES



ITEM NO.	DESCRIPTION	BLADES PER PACK	EAN	MASTER PACK	SHELF PACK
10506431	S617K, HCS, 6" / 150mm 3TPI, Wood Cutting	2	5706915064315	100	1
10506432	S2345X, HCS, 8" / 200mm PROG 4/2,4 TPI, Wood Cutting	2	5706915064322	100	1
10505812	S617K, HCS, 6" / 150mm, 3TPI, Wood Cutting	5	5706915058123	50	1
10505813	S1131L, HCS, 9" / 225mm, 5TPI, Wood Cutting	5	5706915058130	50	1
10505814	S2345X, HCS, 8" / 200mm PROG 4/2.4TPI, Wood Cutting	5	5706915058147	50	1

**FAST CUTTING** in wood composition material & plastic  
**RANGE** of regular (10505812 and 10505813) and progressive teeth (10505814)  
**AVAILABLE** in 3 tooth configurations 3TPI / 5TPI & 4/2.4TPI

## MASONRY RECIPROCATING BLADES



ITEM NO.	DESCRIPTION	BLADES PER PACK	EAN	MASTER PACK	SHELF PACK
10507846	MRB 235 x 20mm 2,5TPI, Masonry Cutting	-	5706915078466	25	1
10507847	MRB 300 x 50mm 2,5TPI, Masonry Cutting	-	5706915078473	25	1
10507848	MRB 450 x 50mm 2,5TPI, Masonry Cutting	-	5706915078480	25	1

**FAST, DURABLE AND PRECISE CUTTING** in many masonry materials like clay bricks, limestone or gas concrete.  
**UNIVERSAL 1/2" SHANK**





## JIGSAW BLADES

This comprehensive jigsaw blade offering has a blade for every application. The range includes both T-shank and U-shank to fit all of today's most popular jigsaw machines.

IRWIN® Jigsaw Blades are manufactured from the following high quality materials:

**HCS** Carbon steel for use in softer materials such as wood, laminated chipboard, and plastics.

**HSS** Fully hardened high-speed steel for use in metal, aluminium, and non-ferrous metal.

### WOOD CUTTING HCS JIGSAW BLADES - T-SHANK



ITEM NO.	DESCRIPTION	BLADES PER PACK	EAN	MASTER PACK	SHELF PACK
10504218	HCS, 100mm, 6 TPI, T144D, Standard, Wood Cutting	5	5706915042184	100	1
10504219	HCS, 100mm, 10 TPI, T101B, Side Ground, Wood Cutting	5	5706915042191	100	1
10504221	HCS, 100mm, 8 TPI, T111C, Standard, Wood Cutting	5	5706915042214	100	1
10504222	HCS, 100mm, 6 TPI, T101D, Side Ground, Wood Cutting	5	5706915042221	100	1
10504223	HCS, 100mm, 10 TPI, T101BR, Side Ground Reverse, Wood Cutting	5	5706915042238	100	1
10504224	HCS, 100mm, 6 TPI, T244D, Standard Contour, Wood Cutting	5	5706915042245	100	1
10504226	HCS, 83mm, 20 TPI, T101AQ, Side Ground Narrow Contour, Wood Cutting	5	5706915042269	100	1
10504227	HCS, 83mm, 12 TPI, T119BQ, Standard Narrow Contour, Wood Cutting	5	5706915042276	100	1
10504228	HCS, 115mm, Progressive 8-13TPI, T234X, Side Ground, Wood Cutting	5	5706915042283	100	1
10504229	HCS, 115mm, 8 TPI, T301CD, Side Ground, Wood Cutting	5	5706915042290	100	1
10504410	HCS, 100mm, 6 TPI, T144DP, Standard Extra Thick 1.68mm, Wood Cutting	5	5706915044102	100	1
10504545	HCS, 100mm, 6 TPI, T144D, Standard, Wood Cutting	100	5706915945454	10	1

**3-SIDED, FLEAM GROUND TEETH** for fast cut and clean finishes  
**FAST AND SMOOTH CUTS** in all wood applications

### METAL CUTTING HSS JIGSAW BLADES - T-SHANK



ITEM NO.	DESCRIPTION	BLADES PER PACK	EAN	MASTER PACK	SHELF PACK
10504220	HSS, 92mm, Progressive 17-23TPI, T118A, Metal Cutting	5	5706915042207	100	1
10504225	HSS, 92mm, Progressive 11-13TPI, T118B, Metal Cutting	5	5706915042252	100	1
10504234	HSS, 92mm, 36 TPI, T118G, Metal Cutting	5	5706915042344	100	1
10504231	HSS, 100mm, 8 TPI, T127D, Metal Cutting	5	5706915042313	100	1
10504233	HSS, 100mm, Progressive 10-20TPI, T123X, Metal Cutting	5	5706915042337	100	1
10504230	HSS, 132mm, 24 TPI, T318A, Metal Cutting	5	5706915042306	100	1

**HSS MILLED TEETH** for longer life and fast cuts in metal  
**EXTENDED LIFE** for fast and even cuts in thin and thick metal

### METAL & WOOD CUTTING BI-METAL JIGSAW BLADES - T-SHANK



ITEM NO.	DESCRIPTION	BLADES PER PACK	EAN	MASTER PACK	SHELF PACK
10504232	BIM, 132mm, Progressive 5-10TPI, T345XF, Metal & Wood Cutting	5	5706915042320	100	1

**PROGRESSIVE TOOTH FORM** for all-purpose cutting in wood and metal  
**BI-METAL CONSTRUCTION** for extended life in wood and metal

# JIGSAW BLADES

## FIBER & PLASTER CARBIDE TIPPED JIGSAW BLADES - T-SHANK



ITEM NO.	DESCRIPTION	BLADES PER PACK	EAN	MASTER PACK	SHELF PACK
10505815	T141HM Carbide Tipped, 100mm, 6TPI, Fiber & Plastic Cutting	1	5706915058154	100	1
10505816	T341HM Carbide Tipped, 132mm, 6TPI	1	5706915058161	100	1

**CARBIDE TIPPED** for long lifetime, especially for abrasive materials

## METAL & WOOD CUTTING JIGSAW BLADE SETS - T-SHANK

ITEM NO.	DESCRIPTION	BLADES PER PACK	EAN	MASTER PACK	SHELF PACK
10505817	Jigsaw Set T-Shank: 2 x 10504221 Wood, 100mm, 8 TPI 2 x 10504218 Wood, 100mm, 6 TPI (fast cut) 2 x 10504219 Wood, 100mm, 10 TPI 1 x 10504222 Wood, 100mm, 6 TPI (clean cut) 2 x 10504220 Metal, 92mm, Progressive 17 - 23 TPI 1 x 10504225 Metal, 92mm, Progressive 11 - 13 TPI	10	5706915058178	50	1



## WOOD CUTTING HCS JIGSAW BLADES - U-SHANK



ITEM NO.	DESCRIPTION	BLADES PER PACK	EAN	MASTER PACK	SHELF PACK
10504235	HCS, 100mm, 6 TPI, U144D, Standard, Wood Cutting	5	5706915042351	100	1
10504288	HCS, 100mm, 10 TPI, U101B, Side Ground, Wood Cutting	5	5706915042887	100	1
10504290	HCS, 100mm, 8 TPI, U111C, Standard, Wood Cutting	5	5706915042900	100	1
10504291	HCS, 100mm, 6 TPI, U101D, Side Ground, Wood Cutting	5	5706915042917	100	1
10504292	HCS, 100mm, 6 TPI, U244D, Standard Contour, Wood Cutting	5	5706915042924	100	1
10504295	HCS, 115mm, Progressive 8-13TPI, U234X, Side Ground, Wood Cutting	5	5706915042955	100	1

**3-SIDED, FLEAM GROUND TEETH** for fast cut and clean finishes  
**FAST AND SMOOTH CUTS** in all wood applications

## METAL CUTTING HSS JIGSAW BLADES - U-SHANK



ITEM NO.	DESCRIPTION	BLADES PER PACK	EAN	MASTER PACK	SHELF PACK
10504289	HSS, 70mm, 24 TPI, U118A, Metal Cutting	5	5706915042894	100	1
10504293	HSS, 70mm, 12 TPI, U118B, Metal Cutting	5	5706915042931	100	1
10504294	HSS, 70mm, 36 TPI, U118G, Metal Cutting	5	5706915042948	100	1
10504297	HSS, 100mm, Progressive 10-20TPI, U123X, Metal Cutting	5	5706915042979	100	1

**HSS MILLED TEETH** for longer life and fast cuts in metal  
**EXTENDED LIFE** for fast and even cuts in thin and thick metal

## METAL & WOOD CUTTING BI-METAL JIGSAW BLADES - U-SHANK



ITEM NO.	DESCRIPTION	BLADES PER PACK	EAN	MASTER PACK	SHELF PACK
10504296	BIM, 132mm, Progressive 5-10TPI, U345XF, Metal & Wood Cutting	5	5706915042962	100	1



**PROGRESSIVE TOOTH FORM** for all-purpose cutting in wood and metal  
**BI-METAL CONSTRUCTION** for extended life in wood and metal

ITEM NO.	PAGE	ITEM NO.	PAGE	ITEM NO.	PAGE	ITEM NO.	PAGE	ITEM NO.	PAGE	ITEM NO.	PAGE	ITEM NO.	PAGE	ITEM NO.	PAGE
T10T	6	10507640	14	T35010E	22	TG24510	28	10505707	36	TM444S6	40	1988934	49	10507771	59
T13T	6	10507641	14	T240	22	TG24512	28	10503532	36	10507932	40	1988936	49	T41211000	59
T11T	6	10505498	14	T23112	22	TG24514	28	10503533	36	10503543	41	1988936	49	T3TON3VS	59
10508019	6	10505500	14	T23212	22	TG2468	28	10507424	36	10503544	41	1988935	49	4935505	59
10508018	6	10505502	14	T233C	22	TG24610	28	10503534	36	10503545	41	1988934	49	T6TON6VS	59
10508017	6	1910231	15	T234C	22	TG24612	28	10503535	36	TM22006	41	10503574	53	8ZR	59
T03T	7	10505877	15	T235C	22	TG56	28	10505162	36	TM220012	41	10503575	53	T52ED	60
T01T	7	10505876	15	T233CDB	22	TG056	28	10505163	36	TMR22089	41	10503576	53	T5212ED	60
T0302EL4	7	10505493	15	T234CDB	22	TG67	28	10505164	36	TMR2210	41	10503577	53	T53ED	60
T0102EL4	7	10505494	15	10504523	24	TG69	28	10505165	36	10503546	41	10503578	53	T52PD	60
T09T	7	10505495	15	10504524	24	TG691	28	TNA2059343000	36	10503547	41	10503579	53	T5212PD	60
T07T	7	10505517	15	10504525	24	TG950	28	TNA2072330000	36	TM2226	41	10503569	53	T53PD	60
T05T	7	10505518	15	10507929	24	TG69NB	28	TXP1211300000	36	TM22261012	41	10503570	53	TV149B	60
T1002EL4	7	10505503	16	10505897	24	10504309N	29	10501671	38	TM1838W	41	10503571	53	TV150B	60
T0902EL4	7	10505504	16	10505898	24	10504310N	29	10501673	38	TM2153	41	10503572	53	TV175B	60
T0702EL4	7	10505505	16	10505899	24	10504311N	29	10501674	38	TM2154	41	10503573	53	TV75B	61
T0502EL4	7	10505506	16	10504520	24	10504313N	29	10501675	38	TMR2049	41	10503564	53	T414	61
T14T	7	10508153	16	10504521	24	10504315N	30	10501676	38	TM2083	41	10503565	53	T1SB	61
T15T	7	10508152	16	10504522	24	10504316N	30	10501678	38	TM2450	41	10503566	53	T3SB	61
T1602EL4	7	10508151	16	10504530	24	10504314N	30	10501679	38	TM2451	41	10503567	53	T4SB	61
T1402EL4	7	10508154	16	10504531	24	10503621	33	10501680	38	T04	42	10503568	53	T6SB	61
T1502EL4	7	10508156	16	10504407	25	10503622	33	10501681	38	TSP4	42	T1365	54	T843423SB	61
10507190	7	10505490	16	10506437	25	10503623	33	10501683	38	T05	42	T1366	54	10507772	61
10507189	7	10505483	16	10504408	25	10503624	33	10501684	38	TSP5	42	T1367	54	FG3	61
T17EL4	7	10505486	17	10504409	25	10503625	33	10501685	38	T07	42	T1369	54	FG4	61
T19EL4	7	10505488	17	T914H	26	1909432	34	10501686	38	T778	42	T13611	54	FG412	61
T18R	7	10505490	17	T918H	26	1912454	34	10501687	38	T06012	42	TL1366	54	FG5	61
T24R	7	10505492	17	T924H	26	1912455	34	10501688	38	T0912	42	T136D	54	FG6	61
T18DR	7	10508161	17	T930H	26	10503628	34	10501689	38	TA151	42	T1352	54	T181C	61
T165EL4	8	10508160	17	T936H	26	10503626	34	10501690	38	TA151R	42	T1353	54	T182C	61
T18EL4	8	10508159	17	T942H	26	10503623	34	10501691	38	TS12	42	T1354	54	T183C	61
T9SP	8	10508158	17	TBC914H	26	1912456	34	10501693	38	TS1238	42	T1355	54	T92C	61
T20EL4	8	10505872	18	TBC918H	26	1909433	34	10504711	38	T0220D	42	T1356	54	T9212C	61
T18SP	8	10505873	18	TBC924H	26	10503630	34	10504712	38	T778D	42	T1357	54	T9312C	61
T24SP	8	10505874	18	TBC930H	26	10503631	34	10503733	38	TA151B	42	T1359	54	T96	61
8	8	10505868	18	TBC936H	26	10505538	35	10501768	39	10505942	45	TL1354	54	TS10	61
4	8	10505869	18	TTBC914	26	10505539	35	10501698	39	10505943	45	T135D	54	T23C	62
2	8	10505870	18	TTBC918	26	10505540	35	10501699	39	10505944	45	T135E	54	T25C	62
12L3	8	10505865	19	TTBC924	26	10505541	35	10501700	39	10505945	45	TM130	54	T112C	62
23	8	10505866	19	TTBC930	26	10505555	35	10501701	39	10505946	45	TM140	54	T114C	62
29	8	10505867	19	TTBC936	26	10505556	35	10501703	39	10505947	45	TM141	54	T36C	62
251	8	10505871	19	TBC924E	26	10505543	35	10501704	39	T506QCEL7	46	TMFC153	54	84C	62
25ZR	8	10505519	19	TWC6	27	10505542	35	10501705	39	TS12QCEL7	46	T1213	55	T23DK	62
27ZR	9	10503642	21	TWC16	27	10503530	35	10503666	39	T518QCEL7	46	T1214	55	T25DK	62
2071910	9	T3008	21	TCC26	27	10503531	35	10501707	39	TS24QCEL7	46	T1216	55	T112DK	62
4092	9	T30010	21	TJ914H	27	10505548	35	10503667	39	T536QCEL7	46	T1218	55	T114DK	62
4935309	9	T30012	21	TJ918H	27	10505549	35	10501708	39	T546EL7	47	T12110	55	T36DK	62
4008	9	T30014	21	TJ924H	27	10505550	35	10501709	39	T5462EL7	47	T12112	55	T84DK	62
4022ZR	9	T30018	21	TJ930H	27	10505544	35	10503668	39	T5412EL7	47	T1224	55	T23L	62
4052ZR	9	T30024	21	TJ936H	27	10505545	35	10501710	39	T54122EL7	47	T1192	55	T25L	62
T7TT	9	T30036	21	TJ942H	27	10505546	35	10503669	39	T53006EL7	47	T1193	55	T112L	62
T214T	9	T30018A	21	TJ918F	27	10505602	35	10503423	39	T530062EL7	47	T1194	55	T114L	62
T76KBT	9	T30036A	21	TJ924F	27	10505603	35	10503670	39	T59100ECD	47	T1196	55	T36L	62
10508020	9	T30018C	21	TJ930F	27	10505547	35	10503425	39	T59200ECD	47	T1203	55	T84L	62
T71	9	T30036C	21	TJ924E	27	TXP1624533000	35	10503835	39	T59400ECD	47	T1204	55	T230	62
4052ZR	9	T30024F	21	T914UEFGT	27	TXP1124610000	35	10503836	39	T58100EL7	47	T1206	55	T250	62
10507626	13	T30036F	21	T918UEFGT	27	TXP1124762000	35	10503429	39	T58200EL7	47	T1208	55	T1120	62
10507627	13	T3508	22	T924UEFGT	27	TXP3011300000	35	10503876	39	T58300EL7	47	T12010	55	T1140	62
10507628	13	T35010	22	T930UEFGT	27	TXP3020533000	35	10503431	39	1826576	47	T12012	55	T360	62
4935097	13	T35012	22	T936UEFGT	27	TXP3020610000	35	10503541	39	1826577	47	T8434	57	T840	62
10507629	13	T35014	22	T942UEFGT	27	TXP3020762000	35	TM44418	40	1826578	47	T36	57	T1C	62
10507630	13	T35018	22	T914KIT	27	TXP3024533000	35	TM44414	40	1826579	47	112	57	T3C	62
10507631	13	T35024	22	T918KIT	27	TXP3024610000	35	TM44438	40	1988919	48	114ZR	57	T4C	62
10507632	13	T35036	22	T924KIT	27	TXP3024762000	35	TM44412	40	1988931	48	23ZR	57	T5C	62
10507633	13	T35048	22	T930KIT	27	TXP1124762000	35	TM44458	40	1988920	48	T25	57	T6C	62
2078116	13	T35018A	22	T936KIT	27	TXP3011300000	35	TM44434	40	1988932	48	1978271	58	T8C	62
2078120	13	T35024A	22	T942KIT	27	TXP3020533000	35	TM44441	40	1988933	48	1978272	58	T1D	62
10507634	14	T35036A	22	TBC914KIT	27	TXP3024533000	35	TM444114	40	1988919	48	1ZR	59	T3D	62
10507635	14	T35048A	22	TBC918KIT	27	10507858	36	TM444112	40	1988920	48	3	59	T4D	62
10507636	14	T35010C	22	TBC924KIT	27	10507860	36	TM4442	40	1988931	48	4ZR	59	T5D	62
10507637	14	T35018C	22	TBC930KIT	27	1965487	36	TM44433	40	1988932	48	5	59	T6D	62
10507638	14	T35024C	22	TBC936KIT	27	10505705	36	TM44434	40	1988933	48	6	59	T8D	62
10507639	14	T35048C	22	TG2458	28	T106150	36	TM44435	40	1988935	49	8ZR	59	T661053	62



# CATALOGUE INDEX

ITEM NO.	PAGE	ITEM NO.	PAGE	ITEM NO.	PAGE	ITEM NO.	PAGE	ITEM NO.	PAGE	ITEM NO.	PAGE	ITEM NO.	PAGE	ITEM NO.	PAGE
T52EDA	63	1951859	66	10508135	77	T591057	89	10507164	96	10502014	99	10502099	102	10501927	105
T5212EDA	63	1951860	66	10508136	77	T660032	89	10507166	96	10502015	99	10502100	102	10501928	105
T53EDA	63	1951861	66	10507843	77	T676810	89	10507167	96	10502016	99	10502101	102	10501929	105
T52EDC	63	1951867	67	10506543	77	T202	90	10501941	98	10502017	99	10502102	102	10501930	105
T5212EDC	63	1951866	67	10506546	77	T2020F	90	10507574	98	10502018	99	10502103	102	10501931	105
T53EDC	63	1951865	67	10506544	77	T202EF	90	10501942	98	10502019	99	10502104	102	10501932	105
T52EDD	63	1951862	67	10506547	77	T20030C	90	10507575	98	10502020	99	10502105	102	10501933	105
T5212EDD	63	1951863	67	10507446	77	T20045	90	10501943	98	10502021	99	10502106	102	10501934	105
T52EDJN	63	1951864	67	10507790	79	T20030CD	90	10501944	98	10502022	99	10502107	102	10501935	105
T5212EDJN	63	1951868	67	10507791	79	T20045D	90	10503844	98	10502023	99	10502108	102	10501936	105
T52EDL	63	1951869	67	10507792	79	T850026	90	10501945	98	10502024	99	10502109	102	10501937	105
T52EDO	63	1951870	67	10508059	79	10507485	90	10501946	98	10502025	99	10502110	102	10501812	106
T5212EDO	63	1951881	67	10508060	79	T210	90	10501947	98	10502027	99	10502111	102	10501813	106
T52EDT	63	1951882	68	10507793	79	T090700	91	10501948	98	10502028	99	10502112	102	10501814	106
T52PDC	63	1951883	68	10507794	79	T090700B	91	10501949	98	10502029	99	10502113	102	10501815	106
T5212PDC	63	1951884	68	10507795	79	T113100D	91	10501950	98	10502030	99	10502115	102	10501816	106
T53PDC	63	1951885	68	10508062	79	T090751	91	10501951	98	10502031	99	10502116	102	10501817	106
T5212PDO	63	1953963	68	10507784	80	T620103	91	10501952	98	10502033	99	10502117	102	10501818	106
T92CC	63	T10771	69	10507785	80	T120422	91	10501953	98	10502035	99	10502118	102	10501819	106
T9212CC	63	T10755	69	10507786	80	T113112	91	10501954	98	10502036	99	10502119	102	10501820	106
T92CD	63	T10756	69	10508052	80	T102010	91	10501955	98	10502038	99	10502120	102	10501821	106
T9212CD	63	T10757	69	10508053	80	T120465	91	10501956	98	10502040	99	10502121	102	10501822	106
T92CE	63	T10758	69	10508054	80	T090757	91	10501957	98	10502041	99	10502122	102	10501823	106
T9312CE	63	T10765	69	10507787	80	T529827	91	10501958	98	10502042	99	10502123	102	10501824	106
T92CF	63	T10767	69	10507788	80	T702025	91	10501959	98	10502043	99	10502124	102	10501826	106
T9312CF	63	T10769	69	10507789	80	T660084	91	10501960	98	10502044	99	10502125	102	10501827	106
T96F	63	T10768	69	10507681	81	T620100A	91	10501961	98	10502046	99	10502126	102	10501830	106
T92CG	63	T10745	69	10507684	81	T620100J	91	10501962	98	10502047	99	10502127	102	10501831	106
T9312CG	63	T10747	69	10507676	82	T630500A	91	10501963	98	10502048	99	10502128	102	10501834	106
T96G	63	10504240	71	10507677	82	T620103	91	10501964	98	10502049	99	10502129	102	10501835	106
T183CA	63	10504241	71	10507682	82	T120422	91	10501965	98	10502050	99	10502130	102	10501836	106
T182CB	63	10504243	71	10507678	82	T630519	91	10501966	98	10502052	99	10502194	103	10501837	106
T183CB	63	10505823	71	10507679	82	T090757	91	10501967	98	10502053	99	10502195	103	10501838	106
T182CC	63	10505824	71	10507680	82	T529827	91	10501968	98	10502054	99	10502196	103	10501841	106
T183CC	63	10507102	71	10507683	82	T201030	91	10501969	98	10502056	99	10502197	103	10501846	106
T183CD	63	10507103	71	648012R	83	TUL223	91	10501970	98	10502057	99	10502198	103	10501847	106
1951676	65	10507104	71	64802	83	T620103	91	10501971	98	10502059	99	10502200	103	10501848	106
1951677	65	10507105	71	64901	83	T220D	91	10501972	98	10502060	99	10503643	103	10501849	106
1951678	65	10508107	72	64902	83	10507124	96	10501973	98	10502061	99	10502184	103	10501850	106
1951679	65	10508108	72	65201	83	10507125	96	10501974	98	10502069	99	10502185	103	10501853	106
1951680	65	10508110	72	1932892	83	10507126	96	10501975	98	10502070	99	10502186	103	10501854	106
1951801	65	10504245	72	1932893	83	10507127	96	10501976	98	10503603	100	10502187	103	10501855	106
1951802	65	10504246	72	1932894	83	10507128	96	10501978	98	10503605	100	10502188	103	10501856	106
1951803	65	10504247	72	664012R	83	10507129	96	10501979	98	10503606	100	10502189	103	10501859	106
1951814	65	10504249	72	66404	83	10507131	96	10501980	98	10503607	100	10502190	103	10501862	106
1951807	65	10504250	72	66406	83	10507132	96	10501981	98	10503609	100	10502191	103	10501863	106
1951808	65	10504251	72	666012	83	10507133	96	10501982	98	10503610	100	10502192	103	10501864	106
1951810	65	10504558	72	666042	83	10507134	96	10501984	98	10503611	100	10503644	103	10501866	106
1951811	65	10504559	72	666062	83	10507135	96	10501985	98	10503612	100	10507198	104	10501867	106
1951812	65	10504561	72	233250	83	10507136	96	10501986	98	10503613	100	10507199	104	10501869	106
1951813	65	10504562	72	66300	83	10507137	96	10501987	98	10502071	100	10507200	104	10501873	106
1951816	65	10504563	72	66305SL	83	10507138	96	10501988	98	10502072	100	10507211	104	10501874	106
1951818	66	10504567	72	10505369	85	10507139	96	10501989	98	10502073	100	10507212	104	10501877	106
1951819	66	10506456	72	10506529	85	10507140	96	10501991	98	10502074	100	10507213	104	10501878	106
1951820	66	1888437	73	10506531	85	10507142	96	10501992	98	10502075	100	10507214	104	10501880	106
1951821	66	1888438	73	10506532	85	10507143	96	10501993	98	10502076	100	10507215	104	10501882	106
1951824	66	1888439	73	10503820	85	10507144	96	10501994	98	10502077	100	10507216	104	10501884	106
1951825	66	10507695	73	10503818	85	10507145	96	10501995	98	10502080	100	10507217	104	10501885	106
1951826	66	10508104	74	10503819	86	10507146	96	10501996	98	10503845	100	10507218	104	10501886	106
1951827	66	10507404	74	10506534	86	10507147	96	10501997	98	10502082	100	10507219	104	10501888	106
1951828	66	10504236	74	10506535	86	10507148	96	10501998	98	10502083	100	10507220	104	10501894	107
1951842	66	10508105	74	10503817	86	10507149	96	10501999	98	10502084	100	10507221	104	10501895	107
1951843	66	10504238	75	10503830	87	10507150	96	10502000	98	10502085	100	10507222	104	10501896	107
1951844	66	10504238	75	10503831	87	10507151	96	10502002	98	10502086	100	10507224	104	10501897	107
1951845	66	10504237	75	10503832	87	10507152	96	10502004	98	10502087	100	10507225	104	10501898	107
1951846	66	10508103	75	10503822	87	10507153	96	10502005	98	10502088	100	10501919	105	10501899	107
1951848	66	10504239	75	10503823	87	10507154	96	10502006	98	10502092	101	10501920	105	10501901	107
1951849	66	10507449	75	10503824	87	10507156	96	10502007	98	10502093	101	10501921	105	10501902	107
1951850	66	10505822	75	10503825	87	10507157	96	10502008	99	10502094	101	10501922	105	10501903	107
1951855	66	10507106	76	10503826	87	10507159	96	10502010	99	10502095	101	10501923	105	10501905	107
1951856	66	10504553	76	10503827	87	10507160	96	10502011	99	10502096	101	10501924	105	10501906	107
1951857	66	10504555	76	10503828	87	10507161	96	10502012	99	10502097	101	10501925	105	10501907	107
1951858	66	10507580	76	10503829	87	10507163	96	10502013	99	10502098	101	10501926	105	10501908	107



# CATALOGUE INDEX

ITEM NO.	PAGE	ITEM NO.	PAGE	ITEM NO.	PAGE	ITEM NO.	PAGE	ITEM NO.	PAGE	ITEM NO.	PAGE	ITEM NO.	PAGE	ITEM NO.	PAGE
10502775	132	1923411	140	10504395	144	10504379	148	1897214	153	10504170	162	10504140	165		
10502776	132	1923412	140	10504396	144	10504380	148	1897215	153	10504171	162	10506427	166		
10502777	132	1923227	140	10504363	144	10504381	148	1897346	153	10504172	162	10506428	166		
10502778	132	1923286	141	10504364	144	10504634	149	1897347	153	10504173	162	10504151	166		
10502779	132	1923287	141	10504365	144	10504635	149	1897348	153	10504174	162	10504157	166		
10502780	132	1923289	141	10504366	144	394100	149	1897349	155	10504175	162	10504159	166		
10502781	132	1923290	141	10504367	144	54125	149	1897350	155	10504176	162	10504141	166		
10502782	132	1923322	141	10504397	144	10504381	149	1897361	155	10504177	162	10504142	166		
10502783	132	1923323	141	10504398	144	1897453	152	1897362	155	10504178	162	10506429	166		
10502784	132	1923326	141	10504399	144	1897454	152	1897363	155	10504179	162	10506430	166		
10502785	132	1923328	141	10504400	144	1897455	152	1897364	155	10504180	162	10504155	166		
10502786	132	1923330	141	10504401	144	1897456	152	1897365	155	10504181	162	10504158	166		
10502787	132	1923332	141	10504338	144	1897457	152	1897366	155	10504182	163	10504160	166		
10502788	132	1923333	141	10504339	144	1897458	152	1897368	155	10504183	163	10504146	166		
10502789	132	1923334	141	10504340	144	1897459	152	1897369	155	10504184	163	10504149	166		
10502790	132	1923335	141	10504344	144	1897460	152	1897370	155	10504185	163	10504144	166		
10507538	133	1923337	141	10504402	144	1897461	152	1897381	155	10504186	163	10504138	166		
10502089	133	1923339	141	10504341	144	1897462	152	1897382	155	10507366	163	10504139	166		
10507110	133	1923340	141	10504342	144	1897463	152	1897383	155	10504187	163	10504150	166		
10507111	133	1923342	141	10504343	144	1897464	152	1897384	155	10504188	163	10507365	167		
10502201	133	1923344	141	10504406	145	1897465	152	1897385	155	10504189	163	10506431	167		
10501938	134	1923346	141	10504368	145	1897466	152	1897386	155	10507367	163	10506432	167		
10501939	134	1923348	141	10504369	145	1897467	152	1897387	155	10504190	163	10505812	167		
10501940	134	1923350	141	10504370	145	1897474	152	1897388	155	10504191	163	10505813	167		
10501892	134	1923352	141	10504371	145	1897475	152	1897389	155	10504192	163	10505814	167		
10501893	134	1923353	141	10504372	145	1897476	152	1897390	155	10504193	163	10507846	167		
10501917	134	1923354	141	10504393	145	1897477	152	1897391	155	10504194	163	10507847	167		
10501918	134	1923355	141	10504394	145	1897478	152	1897392	155	10504195	163	10507848	167		
10507912	135	1923356	141	10504403	145	1897479	152	1897393	155	10504196	163	10504218	168		
10507900	135	1923358	141	10504404	145	1897480	152	1897394	155	10504197	163	10504219	168		
10502234	135	1923359	141	10504837	145	1897468	152	1897086	156	10504198	163	10504221	168		
10503992	135	1923360	141	10504838	145	1897469	152	1897087	156	10504199	163	10504222	168		
10502233	135	1923361	141	10504839	145	1897470	152	1897088	156	10504200	163	10504223	168		
10502570	136	1923362	141	10504840	145	1897471	152	1897089	156	10504201	163	10504224	168		
10503990	136	1923364	141	10504351	145	1897472	152	1897090	156	10504202	163	10504226	168		
10502569	136	1923366	141	10504352	145	1897473	152	1897191	156	10504203	163	10504227	168		
10503730	136	1923368	141	10504353	145	1897395	153	1897192	156	10504204	163	10504228	168		
10502604	136	1923370	141	10504354	145	1897396	153	1907698	156	10504205	163	10504229	168		
10503991	136	1923321	141	10504355	145	1897397	153	1897193	156	10504206	163	10504410	168		
10502603	136	1923331	141	10504356	145	1897398	153	1897194	156	10504207	163	10504545	168		
10502499	137	1923338	141	10504357	145	1897426	153	1897195	156	10504208	163	10504220	168		
10503989	137	1923357	141	10504373	145	1897427	153	1897196	156	10504209	163	10504225	168		
10502500	137	1923502	141	10504374	145	1897428	153	1907699	156	10504210	163	10504234	168		
10502504	137	1923413	141	10504375	145	1897429	153	1897197	156	10504211	163	10504231	168		
10503993	137	1923414	141	10504376	145	1897430	153	1897198	156	10505818	163	10504233	168		
10507720	137	1923228	141	10504358	145	1897431	153	1897199	156	10504212	163	10504230	168		
10507764	137	1923229	141	10504359	145	1897432	153	1897200	156	10504213	163	10504232	168		
10506627	138	1923501	141	10504360	145	1897433	153	1897201	156	10505819	163	10505815	169		
10506628	138	1923419	142	10504361	145	1897434	153	1897202	156	10505820	163	10505816	169		
10507604	138	1923420	142	10504362	145	1897435	153	1897203	156	10505821	163	10505817	169		
10502826	138	1923431	142	10504346	145	1897436	153	1897204	156	10504532	163	10504235	169		
10506629	138	1923432	142	10504347	145	1897448	153	1897205	156	10504536	163	10504288	169		
10507603	138	1923433	142	10504348	145	1897449	153	1897206	156	10504533	163	10504290	169		
1923372	140	1923434	142	10504349	145	1897450	153	1897207	156	10504534	163	10504291	169		
1923373	140	1923435	142	10504350	145	1897451	153	1897208	156	10504535	163	10504292	169		
1923375	140	1923416	142	10504383	145	1897452	153	1907772	156	10507368	163	10504295	169		
1923376	140	1923417	142	10504384	145	1897437	153	1907773	156	10507235	163	10504289	169		
1923377	140	1923418	142	1868193	146	1897438	153	1907774	156	10506439	163	10504293	169		
1923378	140	1923436	143	1868194	146	1897439	153	1907775	156	10506440	163	10504294	169		
1923381	140	1923437	143	1868195	146	1897440	153	1907777	156	10506441	163	10504297	169		
1923383	140	10504387	144	1868196	146	1897441	153	1907778	156	10506442	163	10504296	169		
1923385	140	10504388	144	1868197	146	1897442	153	1907779	156	10506444	163				
1923386	140	10504389	144	1868198	146	1897443	153	1907781	156	10506445	163				
1923387	140	10504390	144	1868199	146	1897444	153	1907782	156	10506424	165				
1923388	140	10504391	144	1868200	146	1897445	153	10504161	162	10506425	165				
1923391	140	10504336	144	1868251	147	1897446	153	10504162	162	10506426	165				
1923392	140	10504330	144	1868252	147	1897447	153	10504163	162	10504147	165				
1923405	140	10504331	144	10504385	148	1897209	153	10504164	162	10504148	165				
1923406	140	10504332	144	10504386	148	1897210	153	10504165	162	10504152	165				
1923407	140	10504392	144	10504382	148	1897211	153	10504166	162	10504153	165				
1923408	140	10504333	144	1840465	148	1907700	153	10504167	162	10504154	165				
1923409	140	10504334	144	10504377	148	1897212	153	10504168	162	10504156	165				
1923410	140	10504335	144	10504378	148	1897213	153	10504169	162	10504143	165				











# MERCHANDISING SOLUTIONS TO DRIVE YOUR SALES



Leverage your store environment and maximise your sell-out with flexible in-store solutions from IRWIN®.

**Ask your sales representative - NOW!**



# IRWIN® TOOLS

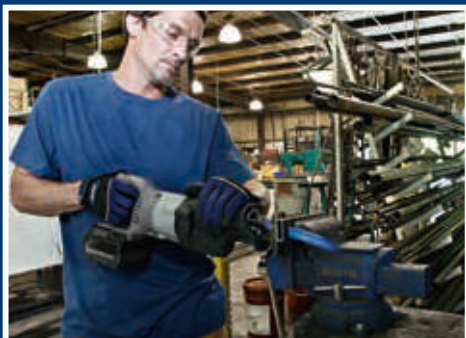
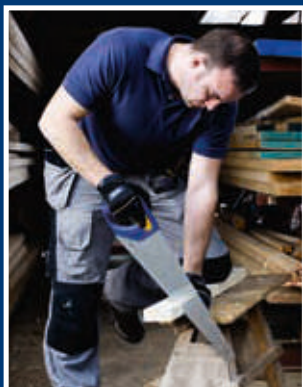

#### NWL Austria GmbH

Schottenring 14,  
A-1010 Vienna  
Austria  
Tel: +43 (0)1206 09 1075

#### NWL Belgium B.V.B.A

Industriepark-Noord 30  
Sint-Niklaas 9100  
Belgium  
Tel :+3227006672  
Netherlands: +31707703978

#### Newell Rubbermaid

**Czech Republic s.r.o.**  
Perlova 371/5  
Prague 1, Stare Mesto 110 00  
Czech Republic  
Tel: +420239014996

#### NWL Denmark Aps

Stamholmen 155, 2nd floor  
2650 Hvidovre  
Denmark  
Tel: +4543314956

#### NWL Finland Oy

c/o Asianajotoimisto DLA Piper  
Finland OY Fabianinkatu 23  
Helsinki 00130  
Finland  
Tel: +358972519252

#### NWL France S.A.S

738, rue Yves Kermen  
Boulogne-Billancourt 92100  
France  
Tel: +33 (0)805 542 537

#### NWL Germany GmbH

Albert-Einstein-Ring 17-21  
22761 Hamburg  
Germany  
Tel: +49 (0) 69 170 776 615

#### Newell Rubbermaid

**Hungary Trading Ltd.**  
Csorsz u. 49-51  
Budapest H-1124  
Hungary  
Tel: +3617779880

#### NWL Italy Srl

Via Benigno Crespi, 19  
Palazzo Mac 4  
20159 Milano  
Italy  
Tel: +39 (0) 029 129 4744

#### NWL Luxembourg S.à r.l

412F route d'Esch  
L-1030  
Luxembourg  
Tel: +35 (0) 224 871 609

#### NWL Norway AS

c/o Advokatfirma DLA Piper  
Norway DA  
Olav Vs gate 4  
Oslo 0114  
Norway  
Tel: + 47 (0) 23024713

#### Newell Poland Services Sp. z o.o.

61-894 Poznań  
Plac Andersa 7  
Poland  
Tel: +48223060213

#### Rubbermaid Portugal Lda

ALargo S. Carlos, No. 3  
1200-410 Lisbon  
Portugal  
Tel: + 351 213 665 471

#### Newell Spain, S.L.

Av. Burgos 12, 2ª izquienda  
28036 Madrid  
Spain  
Tel: +34 910 507 251

#### Newell Rubbermaid Sweden AB

c/o DLA Nordic Box 7315  
Stockholm 1039  
Sweden  
Tel: +0859366363

#### NWL Switzerland Sàrl

Chemin de Blandonnet 10  
1214 Vernier  
Switzerland  
Tel: +41445118342/43

#### Newell Rubbermaid UK Limited

Halifax Avenue - Fradley Park  
Lichfield Staffordshire WS 13 8SS UK  
Main Tel: +44 (0) 1543 44 70 01  
Customer Service Tel: 0844 412 1190,  
0344 4121190  
Customer Service Fax: 0844 412 1184,  
0344 4121184

#### Sanford LLC

Letnikovskaya Street 2, Building 1,  
Moscow 115114  
Russian Federation  
Tel: +48 61 63 98 153

#### Newell Rubbermaid Kırtasiye Ticaret

ve Sanayi Limited Sirketi  
Huzur Mah Fazil Kaftanoglu Cad.  
No. 7/1 Seha Is Merkezi, Seyrantepe Sisli  
Istanbul, Turkey  
Tel: +48 61 63 98 160

#### Newell Rubbermaid Middle East FZE

Dubai Airport Free Zone Building 6W  
Block B, Office 640, P O Box 54554  
Dubai, United Arab Emirates  
Tel: +48 61 63 98 160

#### NWL South Africa (Pty) Limited

150 Fleming St.,  
Meadowdale Gauteng 1614  
South Africa  
Tel: +48 61 63 98 160