

ASSA ABLOY

The global leader in door opening solutions

CATÁLOGO 2017



ASSA ABLOY



ASSA ABLOY

**PRODUCTOS
NUEVOS**

Cerraduras AS-800 / AS-800CH



AS-800



AS-800 CH

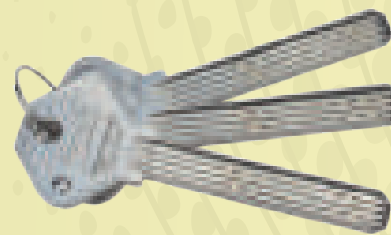

Llave de puntos, dificulta la apertura con ganzúa



- Cerraduras de sobreponer de barra
- Cerrojo de acero sólido
- Rápida y sencilla instalación
- Soldable
- Cinco pernos

Índice	1
Introducción	2
Funciones y especificaciones	3-4
Cerraduras para perfiles de aluminio y accesorios	5-17
Candados	18-38
Línea económica	39-46
Cerraduras de sobreponer	47-59
Cerraduras de embutir	60-61
Tabla de aplicaciones	62-63
Cerraduras electromecánicas	64-67
Cerraduras de mueble	68-74
Bisagras	75-79
Cierrapuertas y bisagras de piso	80-81
Accesorios	82-87



Con una nueva visión de la seguridad y del diseño, consciente del dinamismo y de los grandes retos que representan los mercados globalizados, ASSA ABLOY te presenta su nuevo catálogo 2017. Evolucionando en sus líneas y modelos, satisfaciendo las necesidades del mercado.

ASSA ABLOY es el grupo con las marcas más prestigiadas a nivel mundial, y se ha convertido en el corporativo más grande del mundo, con más de 400 empresas dedicadas a satisfacer las necesidades de seguridad; Phillips, Yale y Tesa brindan a sus clientes un negocio de grandes alcances donde prevalece la confianza, certeza, seguridad y evolución hacia los nuevos tiempos.

Enfatizamos que todos nuestros productos están sometidos a rigurosas pruebas de calidad que son regidas por las normas internacionales de ANSI (organismo que certifica la correcta elaboración de los productos relacionados con la seguridad de bienes y personas). Contamos con tecnología de vanguardia, la cual nos permite controlar la calidad de todos nuestros procesos, desde la materia prima hasta las diversas etapas de fabricación, asegurando que cada producto cumpla con tus expectativas.

ASSA ABLOY crece de tal manera que el futuro lo vemos con mayor optimismo convencidos de que la marca es el segundo activo más importante para el grupo, el primero es nuestra gente.

Nuestra visión:

Ser auténticos líderes mundiales; los proveedores más eficaces e innovadores de soluciones de apertura de puertas. Liderar la innovación y ofrecer a nuestros clientes soluciones seguras, cómodas y bien diseñadas que supongan un verdadero valor añadido.

Nuestros valores básicos:

- La innovación continua en productos de la máxima calidad que satisfagan la demanda del cliente
- La relevancia del cliente en toda nuestra oferta de productos y servicios
- La relación calidad/precio y la disponibilidad de nuestros productos y servicios

¿Cómo elegir correctamente tu cerradura?

Realiza estas preguntas y resolverás las dudas que tengas para adquirir correctamente la cerradura que mejor satisfaga tu necesidad.

1 ¿Qué puerta quieres cerrar?

(La seguridad que requieres para ello)

Uso de la puerta y qué deseas resguardar:

¿Puerta interior, exterior?

¿Material de la puerta?

¿Tienes hijos pequeños?

¿Hogar, comercio, oficina, escuela, hotel, hospital, etc.?

2 ¿Qué diseño te gustaría?

(Combina con tu estilo y tu decoración)

Forma y tipo de la cerradura:

Perilla - Manija - Cerrojo - Gatillo

3 ¿Como identificar si tu cerradura es derecha o izquierda?

Para saber si su cerradura es derecha o izquierda, colóquese en el exterior, si las bisagras están del lado derecho la cerradura es derecha y si están del lado izquierdo, la cerradura es izquierda.

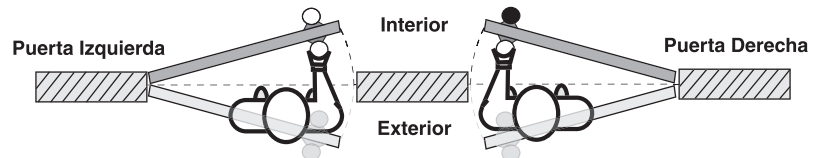

FUNCIONES PERILLAS CILÍNDRICAS			
	Cerraduras para BAÑO o PRIVACÍA.	Al oprimir el botón de la perilla interior, se fija la perilla exterior. En caso de emergencia, para abrir bastará con introducir y girar en la perilla exterior un desarmador o similar.	(S) Pestillo sencillo. Salida antipánico. Sin llave. Con botón al interior. Entrada o Salida de Emergencia.
	Cerraduras para RECÁMARA USOS MÚLTIPLES.	Al girar cualquiera de las dos perillas se retrae el pestillo. Al oprimir el botón de la perilla interior, se fija la perilla exterior. Al girar la perilla interior o la llave, salta el botón automáticamente para abrir. Perilla interior siempre libre.	(PD) Pestillo de seguridad. Llave al exterior / botón al interior. Salida antipánico. (PS) Pestillo sencillo. (pedido especial).

ESPECIFICACIONES PERILLAS CILÍNDRICAS		
1	Certificaciones	ANSI/BHMA A 156.2 Serie 4000
2	Cilindros	Con 5 pernos y 2 llaves
3	Tipo de llave	KD=(estándar), PH-52 (estándar)
4	Abatimiento	Reversible para puertas derechas e izquierdas
5	Backset	60 mm (2 3/8")
6	Fronte del pestillo	25 x 57 mm (1 x 2 1/4")
7	Contra	Estándar
8	Espesor de puerta	35 a 45 mm (1 3/8 x 1 3/4")
9	Preparación de puerta	Perforación para cerradura 54 mm (2 1/8") Perforación para pestillo 25 mm (1")

FUNCIONES PERILLAS TUBULARES

	BAÑO o PRIVACIA	Al girar el botón de la perilla interior, se fija la perilla exterior. En caso de emergencia, para abrir bastará con introducir o girar en la perilla exterior un desarmador o similar.	Pestillo sencillo. Sin llave. Con botón interior. Entrada de emergencia
	RECÁMARA (Barrilete)	Al girar cualquiera de las dos perillas se retrae el pestillo. Al girar el botón de la perilla interior, se fija la perilla exterior. Al girar la perilla interior o la llave, gira el botón.	Pestillo de seguridad. Llave al exterior / botón al interior.
	ENTRADA	Llave al exterior/sin botón al interior. Salida antipánico. (PS) Pestillo sencillo. (PD) Pestillo de seguridad.	Pestillo de seguridad. Llave al exterior.

ESPECIFICACIONES PERILLAS TUBULARES

1	Certificaciones	ANSI/BHMA A 156.2 Serie 4000
2	Cilindros	Con 5 pernos y 2 llaves
3	Tipo de llave	KD=(estándar), PH-52 (estándar)
4	Abatimiento	Reversible para puertas derechas e izquierdas
5	Backset	60 mm (2 3/8")
6	Fronte del pestillo	25 x 57 mm (1 x 2 1/4")
7	Contra	Estándar
8	Espesor de puerta	35 a 45 mm (1 3/8 x 1 3/4")
9	Preparación de puerta	Perforación para cerradura 54 mm (2 1/8") Perforación para pestillo 25 mm (1")

FUNCIONES MANIJAS

	BAÑO o PRIVACIA	Al girar el botón de la manija interior, se fija la manija exterior. En caso de emergencia, para abrir bastará con introducir o girar en la manija exterior un desarmador o similar.	S) Pestillo sencillo. Sin llave al exterior. con botón interior. Entrada de emergencia.
	RECÁMARA	Al girar cualquiera de las dos manijas se retrae el pestillo. Al oprimir el botón de la manija interior, se fija la manija exterior. Al girar la manija interior o la llave, gira el botón para abrir.	(PD) Pestillo de seguridad. Llave al exterior / botón al interior.
	ENTRADA	Sólo se puede abrir desde el exterior con la llave. La manija interior siempre está libre para salida rápida.	(PD) Pestillo de seguridad. Llave al exterior.

ESPECIFICACIONES MANIJAS

1	Cilindros	Con 5 pernos y 2 llaves
2	Tipo de llave	KD=(estándar), PH-52 (estándar)
3	Abatimiento	Reversible para puertas derechas e izquierdas
4	Backset	60 mm (2 3/8")
5	Fronte del pestillo	25 x 57 mm (1 x 2 1/4")
6	Contra	Estándar
7	Espesor de puerta	35 a 45 mm (1 3/8 x 1 3/4")
8	Preparación de puerta	Perforación para cerradura 54 mm (2 1/8") Perforación para pestillo 25 mm (1")

FUNCIONES CERROJOS

	Cerrojos para DEPARTAMENTOS, CASAS O BODEGAS	Medio giro con la llave en el cilindro exterior o la mariposa en el interior proyectará el pestillo para abrir o cerrar. Para sacar la llave debe regresarla a su posición vertical.	Llave al exterior Mariposa al interior
	RECÁMARA Y/O ENTRADA	Perilla con llave al exterior / botón al interior + cerrojo con llave al exterior / llave al interior. Acciona el pestillo con la llave al exterior en ambas cerraduras y con la perilla y la llave del cerrojo al interior.	Llave al exterior Llave al interior

ESPECIFICACIONES CERROJOS

1	Cilindros	5 pernos de latón
2	Tipo de llave	Llave estándar (2)
3	Abatimiento	Reversible para puertas derechas e izquierdas
4	Backset	60 mm (2 3/8")
5	Fronte del pestillo	25 x 57 mm (1 x 2 1/4")
6	Contra	57 x 25 (2 1/4 x 1 3/4)
7	Espesor de puerta	35 a 45 mm (1 3/8 x 1 3/4")
8	Preparación de puerta	Perforación para cerradura 54 mm (2 1/8") Perforación para pestillo 25 mm (1")

FUNCIONES COMBOS

	Cerraduras para ENTRADA PRINCIPAL	Abre desde afuera girando la llave en el cerrojo y en la perilla/manija. Para mantener la perilla/manija exterior fija, (posición de cerrado), oprima/gire el botón de la perilla/manija interior. Para salida, gire media vuelta la mariposa y la perilla interior. También gire el botón.	Cerrojo: llave al exterior. Mariposa al interior. Perilla/Manija: llave al exterior. Botón al interior.
	Cerraduras para ENTRADA PRINCIPAL	Abre desde afuera girando la llave en el cerrojo y en la perilla. Para mantener la perilla exterior fija, (posición de cerrado), oprima/gire el botón de la perilla/manija interior. Para salida gire media vuelta la llave en el cerrojo y gire la perilla/manija interior. También gire el botón.	Cerrojo: llave al exterior. Llave al interior. Perilla/Manija: llave al exterior. Botón al interior
	Cerraduras para ENTRADA PRINCIPAL	Abre desde afuera girando la llave en el cerrojo y en la perilla/manija. Para salida gire media vuelta la mariposa, gire el botón y la perilla/manija interior.	Cerrojo: llave al exterior. Mariposa al interior. Perilla/manija: llave al exterior. Lisa al interior.
	Cerraduras para ENTRADA PRINCIPAL	Abre desde afuera girando la llave en el cerrojo y en la perilla/manija. Para salida gire media vuelta la llave en el cerrojo, gire el botón y gire la perilla/manija interior.	Cerrojo: llave al exterior. Llave al interior. Perilla/manija: llave al exterior. Lisa al interior.

ESPECIFICACIONES COMBOS

1	Certificaciones	ANSI/BHMA A 156.2 Serie 4000
2	Cilindros	Con 5 pernos y 2 llaves
3	Tipo de llave	KD=(estándar), PH-52 (estándar)
4	Abatimiento	Reversible para puertas derechas e izquierdas
5	Backset	60 mm (2 3/8")
6	Fronte del pestillo	25 x 57 mm (1 x 2 1/4")
7	Contra	Estándar
8	Espesor de puerta	35 a 45 mm (1 3/8 x 1 3/4")
9	Preparación de puerta	Perforación para cerradura 54 mm (2 1/8") Perforación para pestillo 25 mm (1")



CATÁLOGO 2017

- Aluminio
- Candados
- Línea Económica
- Sobreponer
- Electromecánicas
- Mueble
- Bisagras
- Cierrapuertas
- Accesorios



Protege lo que quieres)

Aluminio

CERRADURAS



CERRADURA 549



Características de cerraduras de aluminio y accesorios

- Cerraduras residenciales y/o comerciales
- Una fácil inversión de picaportes
- Cilindro con la mejor sujeción tipo profile
- Ideales para puertas de abatir y corredizas

- Los mejores acabados y materiales
- Accesorios para perfiles de aluminio

(Todas las medidas estan en mm)

TABLA DE USOS MÁS COMUNES EN PERFILES DE ALUMINIO

	Perfil A		Puerta corrediza 2"	Puerta corrediza 3"	Puerta batiente 1"	Puerta batiente 1 1/2"	Puerta batiente 1 3/4"	Herculite
Cerradura	Largo máximo embutido	Puerta						
Mod. 400	mm 48.2 / ln 1.894	C-B						
Mod. 425	mm 33.2 / ln 1.307	C						
Mod. 444	NA	C						
Mod. X-450/430	mm 33.4 / ln 1.315	B						
Mod. X-455/435	mm 33.4 / ln 1.315	C						
Mod. 3000	mm 35.5 / ln 1.394	B						
Mod. 3050 / 3055	mm 39.5 / ln 1.550	B						
Mod. 550 / 550 CH / 555	mm 40.4 / ln 1.590	B						
Mod. 550MAX / 549 / 549AS	mm 40.4 / ln 1.590	B						
Mod. 3060	mm 41.2 / ln 1.620	B						
Mod. 3065	mm 41.2 / ln 1.620	B						
Mod. 575	mm 41.6 / ln 1.640	B						
Mod. 530	mm 47.7 / ln 1.878	B						
Mod. 535	mm 47.7 / ln 1.878	C						
Mod. 590	mm 52.0 / ln 2.047	B						
Mod. 595	mm 52.0 / 2.047	C						
Mod. 525	mm 41.5 / ln 1.635	B						



C = Puerta corrediza



B = Puerta batiente

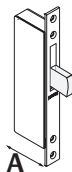

Recomendado



Se usa en una forma común, aunque hay que trabajar el perfil para puertas abatibles

CERRADURAS DE EMBUTIR PARA PERFILES DE ALUMINIO

549

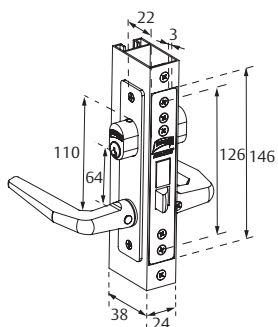

MODELO / FUNCIÓN	SKU	ACABADO	EMPAQUE y MÚLTIPLO
549 Der. / Izq.	2487	Blanco	CAJA 10 pzas.
	2708	Bronce Brillante	
	3170	Dorado	
	2488	Duranodik	
	2606	Hueso	
	2486	Natural	
	2546	Negro	
	4773	Acero Inox (tipo)	

• Para puertas residenciales y comerciales

549 MC

Mariposa-Cilindro

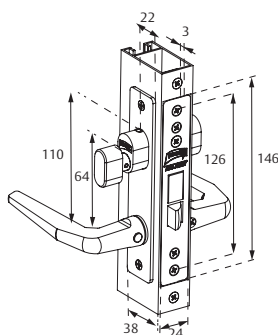

MODELO / FUNCIÓN	SKU	ACABADO	EMPAQUE y MÚLTIPLO
549 MC Der. / Izq.	3434	Natural	CAJA 10 pzas.
	3435	Blanco	
	3436	Duranodik	
	3437	Negro	
	3439	Bronce Brillante	
	5318	Acero Inox (tipo)	

• Para puertas residenciales y comerciales

549 AS

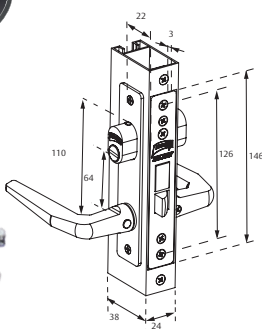

MODELO / FUNCIÓN	SKU	ACABADO	EMPAQUE y MÚLTIPLO
549 AS Der. / Izq.	4999	Blanco	CAJA 10 pzas.
	5000	Natural	
	5001	Duranodik	

• Para puertas residenciales y comerciales

549 B

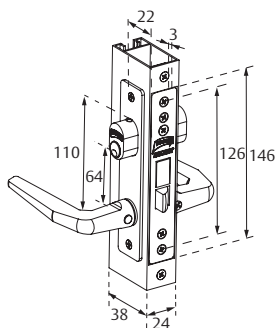

MODELO / FUNCIÓN	SKU	ACABADO	EMPAQUE y MÚLTIPLO
549 B Der. / Izq.	5002	Blanco	CAJA 10 pzas.
	5003	Natural	
	5004	Duranodik	

• Para puertas de baño

CERRADURAS DE EMBUTIR PARA PERFILES DE ALUMINIO

550

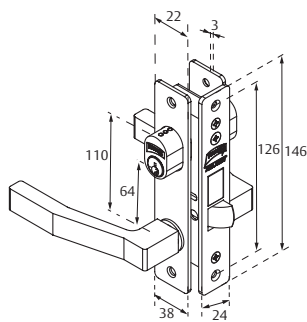

MODELO / FUNCIÓN	SKU	ACABADO	EMPAQUE y MÚLTIPLO
550 Der. / Izq.	592	Blanco	CAJA 10 pzas.
	1727	Bronce Brillante	
	586	Dorado	
	587	Duranodik	
	2373	Hueso	
	585	Natural	
	582	Negro	
4772	Acero Inox (tipo)		

- Para puertas residenciales y comerciales

555

Mariposa - Cilindro

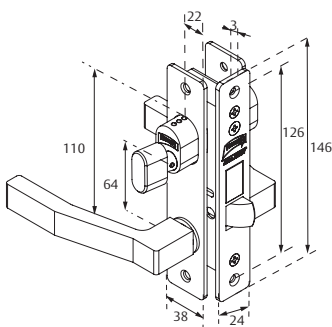

MODELO / FUNCIÓN	SKU	ACABADO	EMPAQUE y MÚLTIPLO
555 Der. / Izq.	2105	Blanco	CAJA 10 pzas.
	3329	Bronce Brillante	
	60	Dorado	
	61	Duranodik	
	59	Natural	
	2136	Negro	

- Para puertas residenciales y comerciales

550 CH

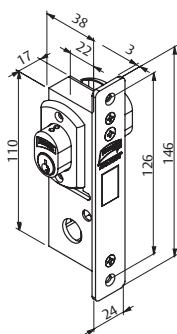

MODELO / FUNCIÓN	SKU	ACABADO	EMPAQUE y MÚLTIPLO
550 CH Der. / Izq.	600	Blanco	CAJA 10 pzas.
	236	Duranodik	
	62	Natural	
	598	Negro	

- Para puertas residenciales y comerciales

570



MODELO / FUNCIÓN	SKU	ACABADO	EMPAQUE y MÚLTIPLO
570 Der. / Izq.	4787	Blanco	CAJA 10 pzas.
	4793	Natural	
	4794	Duranodik	
	4795	Negro	
	4805	Bronce Brillante	

- Para puertas residenciales y comerciales, manija tubular

570 MC Mariposa-Cilindro

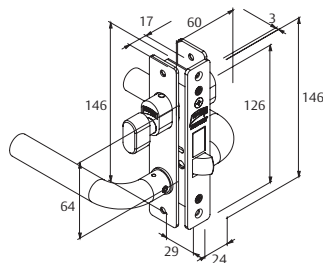

PERNOS
51

MODELO / FUNCIÓN	SKU	ACABADO	EMPAQUE y MÚLTIPLO
570 MC Der. / Izq.	4783	Blanco	CAJA 10 pzas.
	4784	Natural	
	4785	Duranodik	
	4786	Negro	
	4792	Bronce Brillante	

• Para puertas residenciales y comerciales, manija tubular

570 INOX

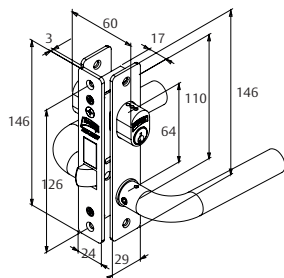

PERNOS
51

MODELO / FUNCIÓN	SKU	ACABADO	EMPAQUE y MÚLTIPLO
570 INOX Der. / Izq.	4866	Acero inox	CAJA 10 pzas.

• Para puertas residenciales y comerciales, manija tubular de acero inoxidable

570 MC INOX Mariposa-Cilindro

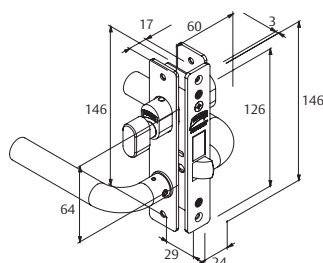

PERNOS
51

MODELO / FUNCIÓN	SKU	ACABADO	EMPAQUE y MÚLTIPLO
570 MC INOX Der. / Izq.	4865	Acero inox	CAJA 10 pzas.

• Para puertas residenciales y comerciales, manija tubular de acero inoxidable

550 MAX MH

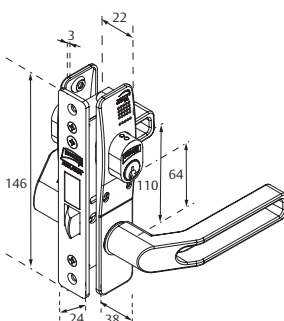

PERNOS
51

MODELO / FUNCIÓN	SKU	ACABADO	EMPAQUE y MÚLTIPLO
550 MAX MH Der. / Izq.	3372	Blanco	CAJA 10 pzas.
	3371	Duranodik	
	3373	Natural	
	3374	Negro	

• Para puertas residenciales y comerciales, manija hueca

550 MAX MR

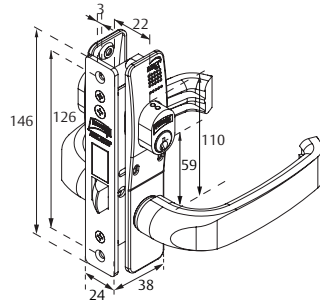

PERNOS
50

MODELO / FUNCIÓN	SKU	ACABADO	EMPAQUE y MÚLTIPLO
550 MAX MR Der. / Izq.	3423	Natural	CAJA 10 pzas.
	3424	Blanco	
	3425	Duranodik	
	3426	Negro	

- Para puertas residenciales y comerciales, manija robusta

3000 OCEAN

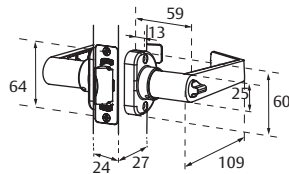

PERNOS
50

MODELO / FUNCIÓN	SKU	ACABADO	EMPAQUE y MÚLTIPLO
3000 Ocean Baño Recámara	3375	Blanco	CAJA 10 pzas.
	3304	Duranodik	
	3163	Cromo Satinado	
3000 Ocean Recámara Entrada	3376	Blanco	CAJA 10 pzas.
	3306	Duranodik	
	3305	Cromo Satinado	

- Para puertas residenciales y comerciales

590



Corrediza

595

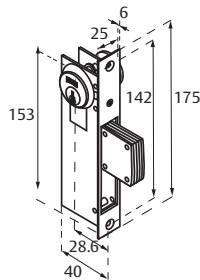

Back set
28.6 mm

Abatible

PERNOS
50

MODELO / FUNCIÓN	SKU	ACABADO	EMPAQUE y MÚLTIPLO
590 Puertas abatibles	2012	Blanco	CAJA 10 pzas.
	472	Duranodik	
	470	Natural	
595 Puertas corredizas	2013	Blanco	CAJA 10 pzas.
	475	Duranodik	
	473	Natural	

- Para puertas residenciales y comerciales

595 CS (Caja soldable)



Back set
28.6 mm

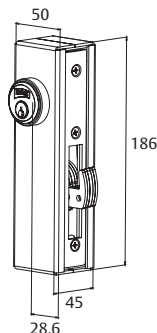

PERNOS
50

MODELO / FUNCIÓN	SKU	ACABADO	EMPAQUE y MÚLTIPLO
595 CS Puertas corredizas	2313	Natural	CAJA 10 pzas.
	2314	Duranodik	

- Para puertas residenciales y comerciales, corredizas con caja soldable, ideal para puertas de herrería

535

Back set
24.6 mm

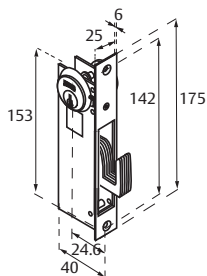

MODELO / FUNCIÓN	SKU	ACABADO	EMPAQUE y MÚLTIPLO
535 Puertas corredizas	2352	Natural	CAJA 1 pza.

• Para puertas corredizas

X-450



X-455

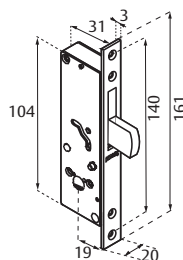

MODELO / FUNCIÓN	SKU	ACABADO	EMPAQUE y MÚLTIPLO
X-450 Puertas abatibles	1873	Blanco	CAJA 10 pzas.
	1245	Duranodik	
	1243	Natural	
X-455 Puertas corredizas	1874	Blanco	CAJA 10 pzas.
	1249	Duranodik	
	1247	Natural	
	2581	Negro	
	1230	Latón antiguo	

• Para puertas de abatir y corredizas, con cilindro tetra de extra seguridad

430

435



435

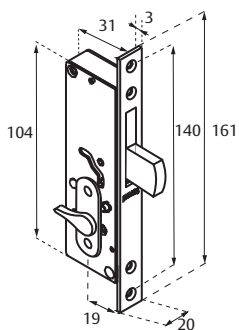
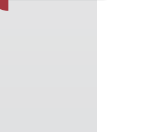

MODELO / FUNCIÓN	SKU	ACABADO	EMPAQUE y MÚLTIPLO
430 Puertas abatibles	1875	Blanco	CAJA 10 pzas.
	1488	Duranodik	
	1484	Natural	
435 Puertas corredizas	1876	Blanco	CAJA 10 pzas.
	1489	Duranodik	
	1485	Natural	

• Para puertas de abatir y corredizas

400 DC

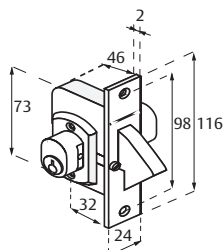

MODELO / FUNCIÓN	SKU	ACABADO	EMPAQUE y MÚLTIPLO
400 DC Puertas corredizas	320	Duranodik	Caja 10 pzas.
	35	Natural	
	38	Cromo	
	36	Latón	

• Para puertas corredizas, uso comercial y residencial

CERRADURAS DE EMBUTIR PARA PERFILES DE ALUMINIO

525 DC

Doble Cilindro



525 MC

Mariposa-Cilindro

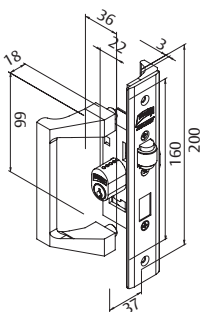

MODELO / FUNCIÓN	SKU	ACABADO	EMPAQUE y MÚLTIPLO
525 DC Der. / Izq.	76	Natural	CAJA 10 pzas.
525 MC Der. / Izq.	288	Natural	

- Tipo vaiven de doble acción, especial para aulas escolares hospitales y lugares que requieran salida rápida en caso de emergencia

575 MM

Manija- Manija

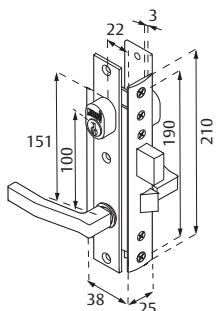

MODELO / FUNCIÓN	SKU	ACABADO	EMPAQUE y MÚLTIPLO
575 MM Der. / Izq.	1066	Blanco	Caja 6 pzas.
	888	Duranodik	
	886	Natural	
	1065	Negro	

- Para uso comercial y residencial

575 JM

Jaladera- Manija

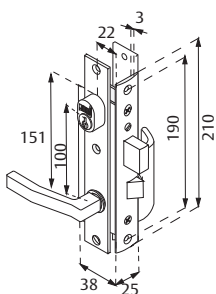

MODELO / FUNCIÓN	SKU	ACABADO	EMPAQUE y MÚLTIPLO
575 JM Der. / Izq.	946	Blanco	Caja 6 pzas.
	1728	Bronce Brillante	
	891	Duranodik	
	889	Natural	
	1064	Negro	

- Para uso comercial y residencial

3050

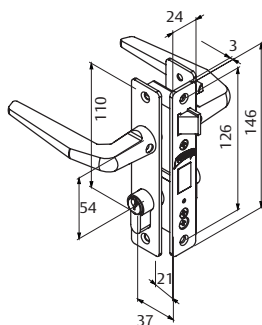

MODELO / FUNCIÓN	SKU	ACABADO	EMPAQUE y MÚLTIPLO
3050 Der. / Izq.	2440	Blanco	Caja 6 pzas.
	2439	Duranodik	
	2438	Natural	
	2441	Negro	

- Para uso comercial y residencial

3055



PERNOS
50

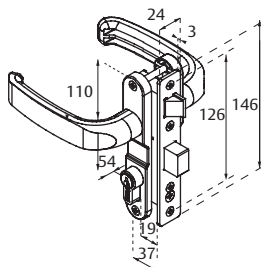

MODELO / FUNCIÓN	SKU	ACABADO	EMPAQUE y MÚLTIPLO
3055 Der. / Izq.	2446	Blanco	Caja 6 pzas.
	2445	Duranodik	
	2444	Natural	
	2447	Negro	

• Para uso comercial y residencial

3060 MM

Manija- Manija



PERNOS
50

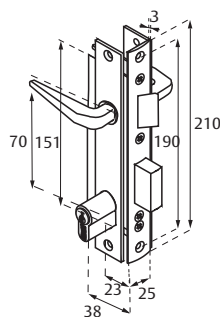

MODELO / FUNCIÓN	SKU	ACABADO	EMPAQUE y MÚLTIPLO
3060 MM Der. / Izq.	2454	Natural	Caja 6 pzas.
	2458	Blanco	
	2456	Duranodik	

• Para uso comercial y residencial

3060 JM

Jaladera- Manija



PERNOS
50

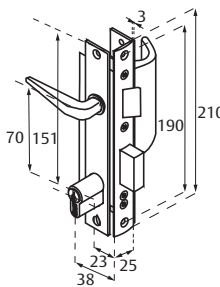

MODELO / FUNCIÓN	SKU	ACABADO	EMPAQUE y MÚLTIPLO
3060 JM Der. / Izq.	2448	Natural	Caja 6 pzas.
	2452	Blanco	
	2450	Duranodik	

• Para uso comercial y residencial

3065 MM

Manija- Manija



PERNOS
50

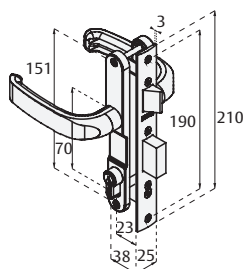

MODELO / FUNCIÓN	SKU	ACABADO	EMPAQUE y MÚLTIPLO
3065 MM Der. / Izq.	2460	Natural	Caja 6 pzas.
	2462	Blanco	
	2461	Duranodik	

• Para uso comercial y residencial

3065 JM

Jaladera- Manija

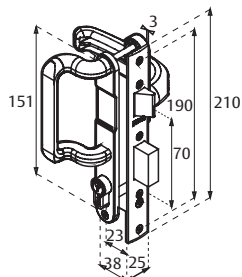

MODELO / FUNCIÓN	SKU	ACABADO	EMPAQUE y MÚLTIPLO
3065 JM Der. / Izq.	2464	Natural	Caja 6 pzas.
	2466	Blanco	
	2465	Duranodik	

- Para uso comercial y residencial

425 CI

Cilindro Interior

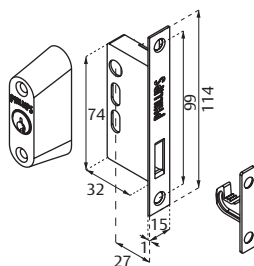

MODELO / FUNCIÓN	SKU	ACABADO	EMPAQUE y MÚLTIPLO
425 CI Der. / Izq.	2039	Natural	Caja 10 pzas.
	2042	Blanco	
	2045	Duranodik	

- Para puertas y ventanas corredizas, uso comercial y residencial

425 DC

Doble Cilindro

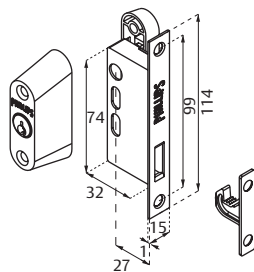

MODELO / FUNCIÓN	SKU	ACABADO	EMPAQUE y MÚLTIPLO
425 DC Der. / Izq.	2037	Natural	Caja 10 pzas.
	2040	Blanco	
	2043	Duranodik	

- Para puertas y ventanas corredizas, uso comercial y residencial

425 MC

Mariposa-Cilindro

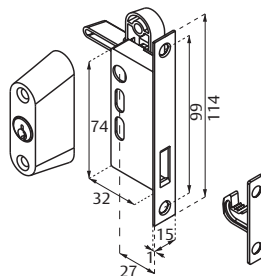

MODELO / FUNCIÓN	SKU	ACABADO	EMPAQUE y MÚLTIPLO
425 MC Der. / Izq.	2038	Natural	Caja 10 pzas.
	2041	Blanco	
	2044	Duranodik	

- Para puertas y ventanas corredizas, uso comercial y residencial

444 MC



PERNOS
50

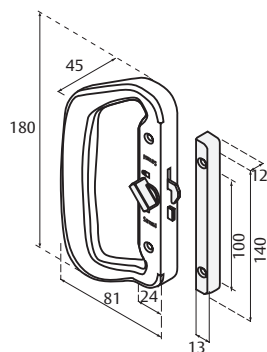

MODELO / FUNCIÓN	SKU	ACABADO	EMPAQUE y MÚLTIPLO
444 MC Para puertas y/o ventanas corredizas	2646	Natural	Caja 12 pzas.
	2647	Blanco	
	2648	Duranodik	
	2649	Negro	

- Jaladera de sobreponer con cilindro, para puertas y ventanas corredizas de 18 cm de longitud

444

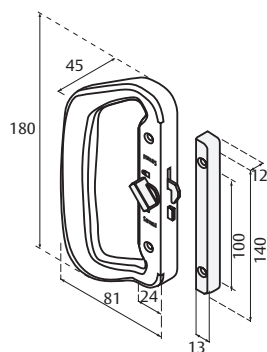

MODELO / FUNCIÓN	SKU	ACABADO	EMPAQUE y MÚLTIPLO
444	2642	Natural	Caja 12 pzas.
	2643	Blanco	
	2644	Duranodik	
	2645	Negro	

- Jaladera de sobreponer, para puertas y ventanas corredizas de 18 cm de longitud

444 CH

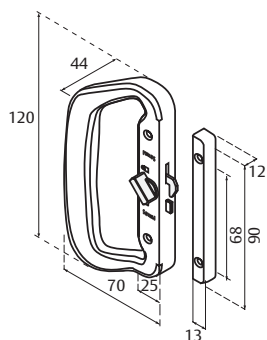

MODELO / FUNCIÓN	SKU	ACABADO	EMPAQUE y MÚLTIPLO
444 CH	2650	Natural	Caja 8 pzas.
	2651	Blanco	
	2652	Duranodik	
	2653	Negro	

- Jaladera de sobreponer, para puertas y ventanas corredizas de 12 cm de longitud

43 MAN

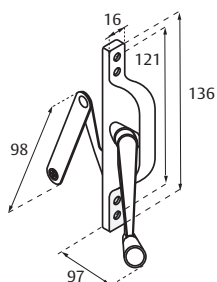

MODELO / FUNCIÓN	SKU	ACABADO	EMPAQUE y MÚLTIPLO
43 MAN Manivela	138	Natural	Caja 25 pzas.
	580	Blanco	
	298	Duranodik	
	578	Negro	

- Operador de celosías para persianas de vidrio

43 MAR

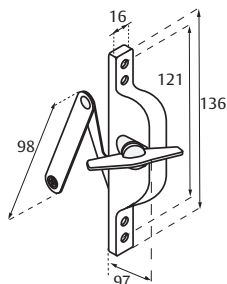

MODELO / FUNCIÓN	SKU	ACABADO	EMPAQUE y MÚLTIPLO
43 MAR Mariposa	295	Natural	Caja 25 pzas.
	581	Blanco	
	299	Duranodik	
	579	Negro	

- Operador de celosías para persianas de vidrio

3327

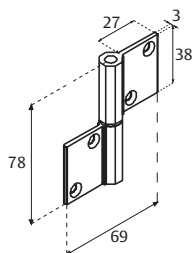

MODELO / FUNCIÓN	SKU	ACABADO	EMPAQUE y MÚLTIPLO
BISAGRA 3327	2112	Natural	Caja 20 pzas.
	2114	Blanco	
	2113	Duranodik	
	2115	Negro	
	2375	Bronce Brillante	

- Bisagra de aluminio para puertas y ventanas de abatir

3110

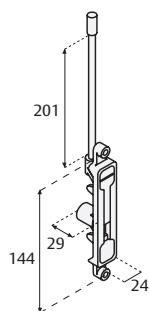

MODELO / FUNCIÓN	SKU	ACABADO	EMPAQUE y MÚLTIPLO
PASADOR DE MAROMA 3110	2303	Natural	Caja 1 pza.
	2305	Blanco	
	2304	Duranodik	

- Pasador de maroma de embutir con offset de 1/8" (espesor del perfil)

3308, 3312 y 3316

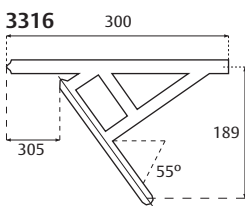
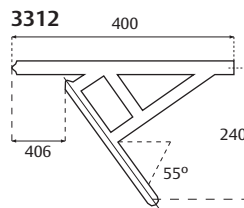
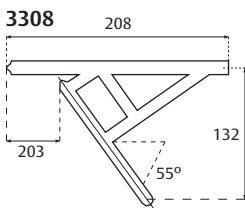

MODELO / FUNCIÓN	SKU	EMPAQUE
BRAZO DE PROYECCIÓN 3308(8")	2300	Caja 1 pzas.
BRAZO DE PROYECCIÓN 3312(12")	2301	
BRAZO DE PROYECCIÓN 3316(16")	2302	

- Brazos de proyección para ventanas

Candados



CANDADO AS-9

Características de candados

- Latón línea robusta
- Latón línea esbelta
- Latón línea internacional
- Latón línea extra seguridad
- Metálicos
- Metálicos línea extra seguridad
- Laminados
- Especiales
- Para cortina
- Hierro

(Todas las medidas estan en mm)

TABLA DE USOS MÁS COMUNES



Candado											
Mod. 12 / 12 GL											
Mod. 13 / 13 GL											
Mod. 14 / 14 GL											
Mod. 15 / 15 GL											
Mod. 16 / 16 GL											
Mod. 17 / 17 GL											
Mod. 18 / 18 GL											
Mod. 19 / 19 GL											
Mod. LI-40											
Mod. LI-45											
Mod. LI-50											
Mod. LI-60											
Mod. TX-35											
Mod. TX-40											
Mod. TX-50											
Mod. TX-60											
Mod. AS-40											
Mod. AS-50											
Mod. AS-60											
Mod. ST-40											
Mod. ST-50											
Mod. 6/6 GL											
Mod. 112 / 112 GL											
Mod. 113 / 113 GL											
Mod. 114 / 114 GL											
Mod. 115 / 115 GL											
Mod. 116 / 116 GL											
Mod. 114 P											
Mod. TX-140											
Mod. TX-150											
Mod. TX-160											
Mod. AS-140											
Mod. AS-150											
Mod. AS-160											
Mod. LAM 30											
Mod. LAM 40											
Mod. LAM 50											
Mod. LAM 50 GL											
Mod. 4											
Mod. 8											
Mod. 11											
Mod. 20											
Mod. 9 / Mod. AS-9 / Mod. TX-9											
Mod. 10/ TX10/AS10/110/TX110											
Mod. Digital 35											
Mod. Digital 40											
Mod. 240 / 250 GL											
Mod. 250 / 240 GL											
Mod. 260 / 260 GL											
Mod. 102 / 102GL											
Mod. 103 / 103GL											
Mod. 103 / 103GL											
Mod. 105 / 105GL											
Mod. TSAP3/TSAM3/TSAM4											
BICIGAN / BICICAB											



**CANDADO
DE SEGURIDAD**



Candados con la *seguridad necesaria* para tu protección, recomendado como *seguridad básica*.



**EXTRA
SEGURIDAD**



Seguridad reforzada para tu protección, *recomendado para uso rudo* comercial y residencial.



**ALTA
SEGURIDAD**



Máximo nivel de seguridad para tu protección, recomendado para todo uso comercial, residencial e industrial.

15, 15 GL

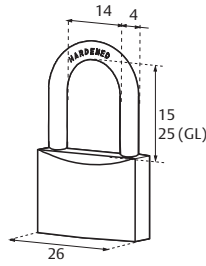

SKU	MODELO	EMPAQUE y MÚLTIPLO
118	15 Gancho corto	Caja/ 12 pzas.
119	15 Gancho largo	

16, 16 GL

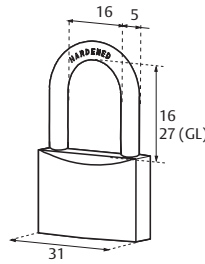

SKU	MODELO	EMPAQUE y MÚLTIPLO
120	16 Gancho corto	Caja/ 12 pzas.
121	16 Gancho largo	

17, 17 GL

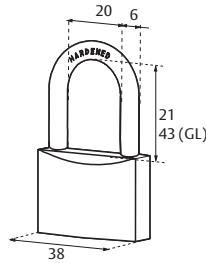

SKU	MODELO	EMPAQUE y MÚLTIPLO
239	17 Gancho corto	Caja/ 12 pzas.
240	17 Gancho largo	
290	17 Gancho largo	Blisters / 6 pzas.

18, 18 GL

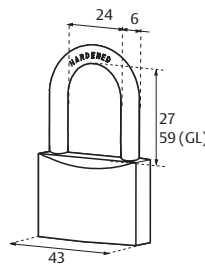

SKU	MODELO	EMPAQUE y MÚLTIPLO
241	18 Gancho corto	Caja/ 12 pzas.
242	18 Gancho largo	

20 GEMELO

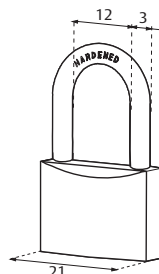

SKU	MODELO	EMPAQUE y MÚLTIPLO
2321	20 Gemelos	Blisters / 6 pzas.



CANDADOS DE LATÓN MACIZO DE EXTRA SEGURIDAD



12, 12 GL

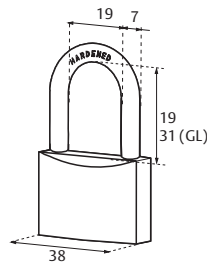

SKU	MODELO / FUNCIÓN	EMPAQUE y MÚLTIPLO
112	12 Gancho corto	Caja / 12 pzas.
113	12 Gancho largo	
256	12 Gancho largo	Blister / 6 pzas.

12 GL GEMELO

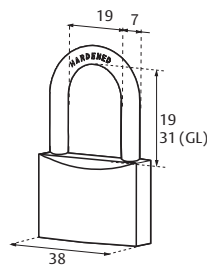

SKU	MODELO / FUNCIÓN	EMPAQUE y MÚLTIPLO
4604	12 Gancho largo Gem.	Caja / 6 pzas.
4605	12 Gancho largo Gem.	Blister / 6 pzas.

LI-40, LI-45

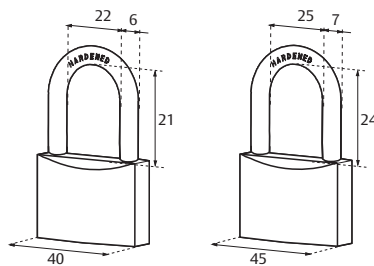

SKU	MODELO / FUNCIÓN	EMPAQUE y MÚLTIPLO
1565	LI-40	Caja / 12 pzas.
1566	LI-45	

LI-50, LI-60

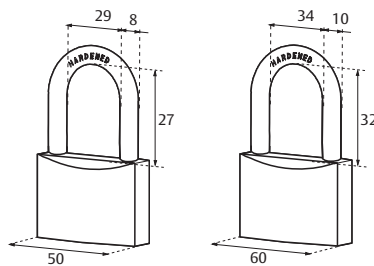

SKU	MODELO / FUNCIÓN	EMPAQUE y MÚLTIPLO
1567	LI-50	Caja / 6 pzas.
1568	LI-60	

19, 19 GL

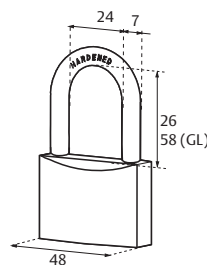

SKU	MODELO / FUNCIÓN	EMPAQUE y MÚLTIPLO
243	19 Gancho corto	Caja / 12 pzas.
244	19 Gancho largo	

13, 13 GL

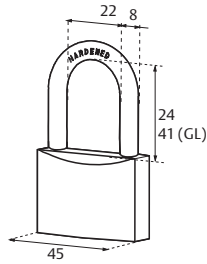

SKU	MODELO / FUNCIÓN	EMPAQUE y MÚLTIPLO
114	13 Gancho corto	Caja/ 12 pzas.
115	13 Gancho largo	
258	13 Gancho largo	Blister / 6 pzas.

14, 14 GL

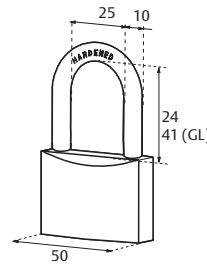

SKU	MODELO / FUNCIÓN	EMPAQUE y MÚLTIPLO
116	14 Gancho corto	Caja/ 6 pzas.
117	14 Gancho largo	
260	14 Gancho largo	Blister / 6 pzas.

TX-35, TX-40

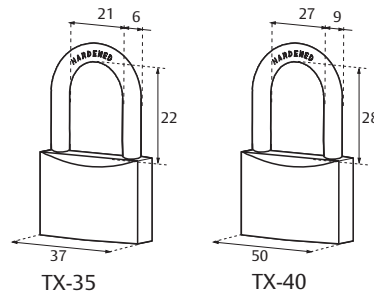

SKU	MODELO / FUNCIÓN	EMPAQUE y MÚLTIPLO
452	TX-35	Caja/ 6 pzas.
453	TX-40	
477	TX-40 BP	Blister / 6 pzas.

TX-50, TX-60

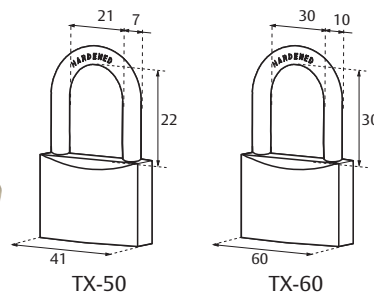

SKU	MODELO / FUNCIÓN	EMPAQUE y MÚLTIPLO
454	TX-50	Caja/ 6 pzas.
455	TX-60	

ST-40, ST-50

Con **3** llaves

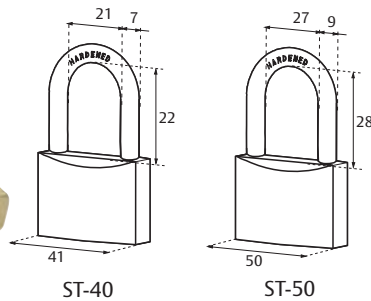

PERNOS **71**

SKU	MODELO / FUNCIÓN	EMPAQUE y MÚLTIPLO
1260	ST-40	Caja/6 pzas.
1261	ST-50	

AS-40, AS-50

Con **5** llaves



PERNOS **91**

PERNOS **121**

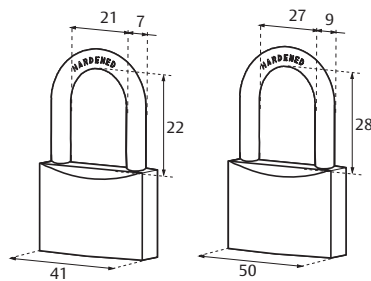

SKU	MODELO / FUNCIÓN	EMPAQUE y MÚLTIPLO
1262	AS-40	Caja/6 pzas.
1263	AS-50	Caja/6 pzas.

AS-60

Con **5** llaves

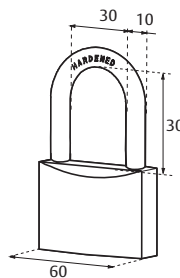

PERNOS **121**

SKU	MODELO / FUNCIÓN	EMPAQUE y MÚLTIPLO
1264	AS-60	Caja/6 pzas.



Candados de latón:

Candados fabricados en latón macizo con cilindro y mecanismo de pernos de latón y contra pernos de carrete para un mejor funcionamiento. Gancho de acero templado para mayor resistencia al corte. Ideal para exteriores, mayor resistencia a la intemperie.

VERSIONES:
Gancho largo y gancho corto.

115 / 115 GL

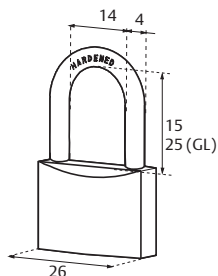

PERNOS
4

SKU	MODELO / FUNCIÓN	EMPAQUE y MÚLTIPLO
128	115 Gancho corto	Caja/ 12 pzas.
129	115 Gancho largo	
271	115 Gancho corto	Blister / 6 pzas.
272	115 Gancho largo	

116 / 116 GL

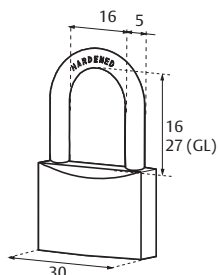

SKU	MODELO / FUNCIÓN	EMPAQUE y MÚLTIPLO
130	116 Gancho corto	Caja/ 12 pzas.
131	116 Gancho largo	
273	116 Gancho corto	Blister / 6 pzas.
274	116 Gancho largo	

EXTRA SEGURIDAD

CANDADOS METÁLICOS DE EXTRA SEGURIDAD

6 / 6GL

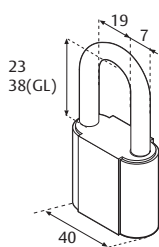

PERNOS
4

SKU	MODELO / FUNCIÓN	EMPAQUE y MÚLTIPLO
412	6 Gancho corto	Caja/ 12 pzas.
1363	6 Gancho largo	
551	6 Gancho corto	Blister / 6 pzas.
1398	6 Gancho largo	

6 GL GEMELO



Ambos abren
con una
MISMA LLAVE

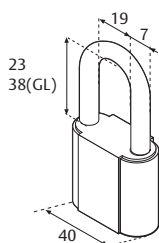

PERNOS
4

SKU	MODELO / FUNCIÓN	EMPAQUE y MÚLTIPLO
1499	6 Gancho largo Gemelo	Blister / 6 pzas.



CANDADOS METÁLICOS DE EXTRA SEGURIDAD



6 - 4 X 4

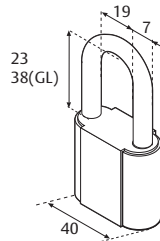

SKU	MODELO / FUNCIÓN	EMPAQUE y MÚLTIPLO
1711	6 Gancho corto 4x4	Blister / 6 pzas.

6 / 6 GL LATÓN

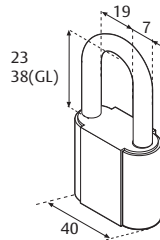

SKU	MODELO / FUNCIÓN	EMPAQUE y MÚLTIPLO
1546	6 Latón	Blister / 6 pzas.
1895	6 Latón gancho largo	

6 AZUL, VERDE

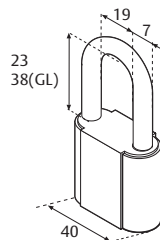

SKU	MODELO / FUNCIÓN	EMPAQUE y MÚLTIPLO
1544	6 Azul	Caja / 12 pzas.
2200	6 Verde	

6 ROJO, AMARILLO

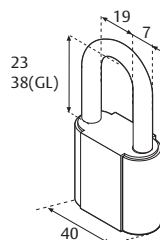

SKU	MODELO / FUNCIÓN	EMPAQUE y MÚLTIPLO
1526	6 Amarillo	Caja / 12 pzas.
1528	6 Rojo	



CANDADOS LAMINADOS DE EXTRA SEGURIDAD



LAM-30

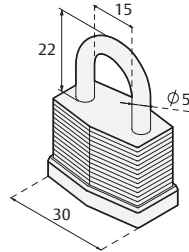

SKU	MODELO / FUNCIÓN	EMPAQUE y MÚLTIPLO
2498	LAM - 30	Blister / 6 pzas.

LAM-40

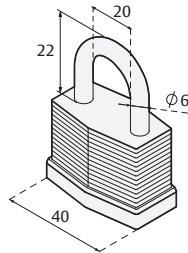

SKU	MODELO / FUNCIÓN	EMPAQUE y MÚLTIPLO
2499	LAM - 40	Blister / 6 pzas.

LAM-50

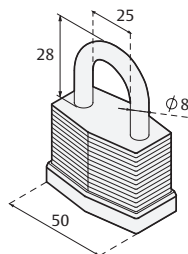

SKU	MODELO / FUNCIÓN	EMPAQUE y MÚLTIPLO
2501	LAM - 50	Blister / 6 pzas.

LAM-50 GEMELO

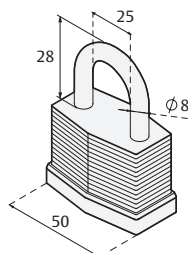

SKU	MODELO / FUNCIÓN	EMPAQUE y MÚLTIPLO
3445	LAMINADO-50 Gemelo	Blister/6 pzas.



CANDADOS LAM. Y METÁLICOS DE EXTRA SEGURIDAD



LAM-50 GL

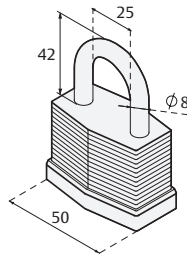

SKU	MODELO / FUNCIÓN	EMPAQUE y MÚLTIPLO
3446	LAM-50 Gancho largo	Caja/12 pzas.
3447	LAM-50 Gancho largo	Blister/6 pzas.

112/112 GL

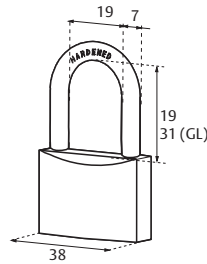

SKU	MODELO / FUNCIÓN	EMPAQUE y MÚLTIPLO
122	112 Gancho corto	Caja/ 12 pzas.
123	112 Gancho largo	
265	112 Gancho corto	Blister / 6 pzas.
266	112 Gancho largo	

112 GL GEMELO

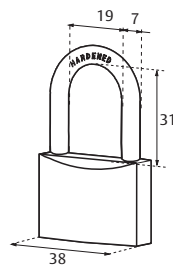

SKU	MODELO / FUNCIÓN	EMPAQUE y MÚLTIPLO
1177	112 Gancho largo Gemelo	Blister / 6 pzas.

112 4 X 4

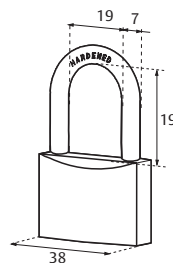

SKU	MODELO / FUNCIÓN	EMPAQUE y MÚLTIPLO
1712	112 Gancho corto 4 x 4	Blister / 6 pzas.



CANDADOS METÁLICOS DE ALTA SEGURIDAD



113/113 GL

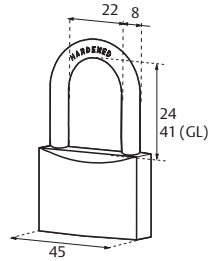

SKU	MODELO / FUNCIÓN	EMPAQUE y MÚLTIPLO
124	113 Gancho corto	Caja/ 12 pzas.
125	113 Gancho largo	
267	113 Gancho corto	Blister / 6 pzas.
268	113 Gancho largo	

113 GL GEMELO

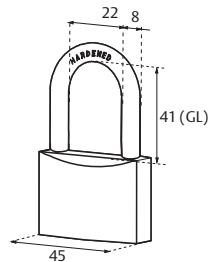
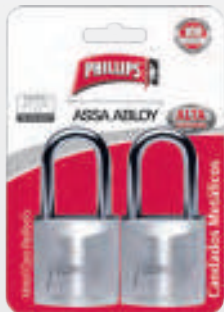

SKU	MODELO / FUNCIÓN	EMPAQUE y MÚLTIPLO
1178	113 Gancho largo Gemelo	Blister / 6 pzas.

113 4 X 4

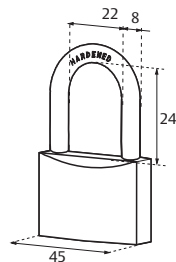

SKU	MODELO / FUNCIÓN	EMPAQUE y MÚLTIPLO
1713	113 Gancho corto 4 x 4	Blister / 6 pzas.

114/114 GL

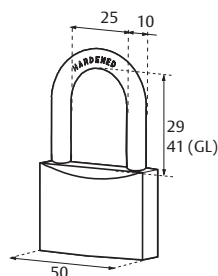

SKU	MODELO / FUNCIÓN	EMPAQUE y MÚLTIPLO
126	114 Gancho corto	Caja/ 12 pzas.
127	114 Gancho largo	
269	114 Gancho corto	Blister / 6 pzas.
270	114 Gancho largo	

114 PROTEGIDO

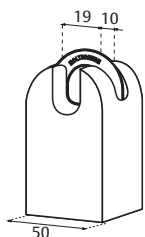

PERNOS
50

SKU	MODELO / FUNCIÓN	EMPAQUE y MÚLTIPLO
2419	114 Protegido	Caja/6 pzas.
2420	114 Protegido	Blister/6 pzas.

TX-140

Con **3**
llaves

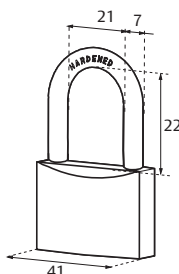

PERNOS
12

SKU	MODELO / FUNCIÓN	EMPAQUE y MÚLTIPLO
2290	TX-140	Caja/6 pzas.

TX-150

Con **3**
llaves

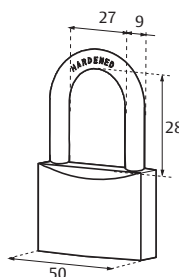

PERNOS
16

SKU	MODELO / FUNCIÓN	EMPAQUE y MÚLTIPLO
2292	TX-150	Caja/6 pzas.

TX-160

Con **3**
llaves

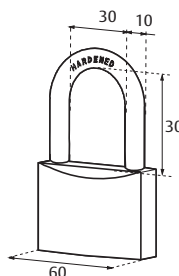

PERNOS
16

SKU	MODELO / FUNCIÓN	EMPAQUE y MÚLTIPLO
2294	TX-160	Caja/6 pzas.

AS-140

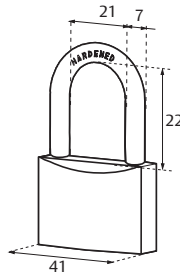

SKU	MODELO / FUNCIÓN	EMPAQUE y MÚLTIPLO
2284	AS-140	Caja/ 6 pzas.

AS-150

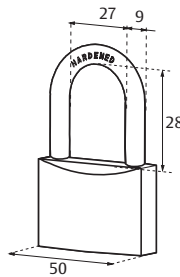

SKU	MODELO / FUNCIÓN	EMPAQUE y MÚLTIPLO
2286	AS-150	Caja/ 6 pzas.

AS-160

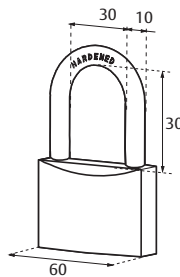

SKU	MODELO / FUNCIÓN	EMPAQUE y MÚLTIPLO
2288	AS-160	Caja/ 6 pzas.



Candados metálicos:

Candados fabricados en aleación metálica con mecanismo de pernos de latón y contra pernos de carrete para un mejor funcionamiento. Gancho de acero templado para mayor resistencia al corte.

VERSIONES:
Gancho largo y gancho corto.

240 - 240 GL

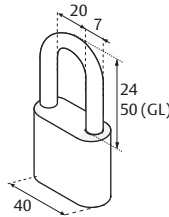

LLAVES RADIALES
Sistema de combinación por discos

SKU	MODELO / FUNCIÓN	EMPAQUE y MÚLTIPLO
2774	240 Gancho corto	Blister/ 6 pzas.
2999	240 Gancho largo	

250 - 250 GL

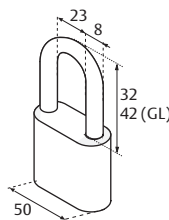

LLAVES RADIALES
Sistema de combinación por discos

SKU	MODELO / FUNCIÓN	EMPAQUE y MÚLTIPLO
2775	250 Gancho corto	Blister/ 6 pzas.
3000	250 Gancho largo	

260 - 260 GL

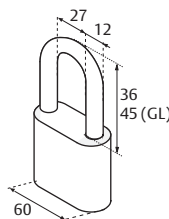

LLAVES RADIALES
Sistema de combinación por discos

SKU	MODELO / FUNCIÓN	EMPAQUE y MÚLTIPLO
2780	260 Gancho corto	Blister/ 6 pzas.
3001	260 Gancho largo	



Candados de acero:

*Candados de acero con llave radial de alta seguridad, sistema tipo ABLOY.
Cuerpo de acero con recubrimiento metálico. Con llave retenida en candado abierto. El gancho se debe desembragar de forma manual. Doble cerrojo de balín de acero mayor resistencia al impacto. Gancho de acero templado, aumenta la resistencia al corte y aserrado.*

VERSIONES:
Gancho largo y gancho corto.

102 - 102 GL

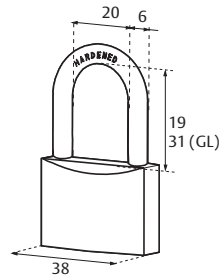

PERNOS
41

SKU	MODELO / FUNCIÓN	EMPAQUE y MÚLTIPLO
3398	102 Gancho corto	Caja / 12 pzas.
3399	102 Gancho largo	
3400	102 Gancho corto	Blister / 6 pzas.
3401	102 Gancho largo	

103 - 103 GL

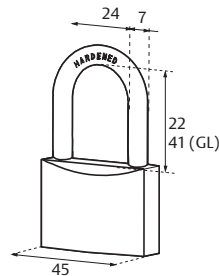

PERNOS
51

SKU	MODELO / FUNCIÓN	EMPAQUE y MÚLTIPLO
3402	103 Gancho corto	Caja / 12 pzas.
3403	103 Gancho largo	
3405	103 Gancho largo	Blister / 6 pzas.

104 - 104 GL

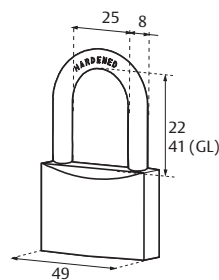

PERNOS
51

SKU	MODELO / FUNCIÓN	EMPAQUE y MÚLTIPLO
3406	104 Gancho corto	Caja / 6 pzas.
3407	104 Gancho largo	

105 - 105 GL

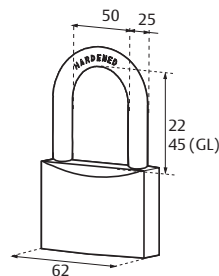

PERNOS
51

SKU	MODELO / FUNCIÓN	EMPAQUE y MÚLTIPLO
3412	105 Gancho corto	Caja / 6 pzas.
3413	105 Gancho largo	

9

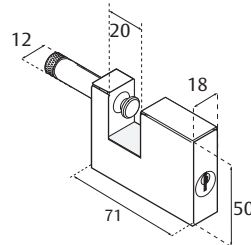

PERNOS
50

SKU	MODELO / FUNCIÓN	EMPAQUE y MÚLTIPLO
111	9 Latón	Caja / 6 pzas.
254	9 Latón	Blister / 6 pzas.

10

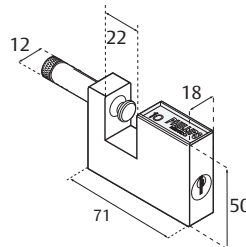

PERNOS
50

SKU	MODELO / FUNCIÓN	EMPAQUE y MÚLTIPLO
301	10 AMP Metálico	Caja / 6 pzas.
307	10 AMP Metálico	Blister / 6 pzas.

110

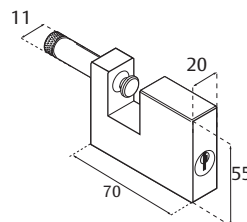

PERNOS
50

SKU	MODELO / FUNCIÓN	EMPAQUE y MÚLTIPLO
3462	110 Hierro	Caja / 6 pzas.
3463	110 Hierro	Blister / 6 pzas.

TX-110

Con **3**
llaves

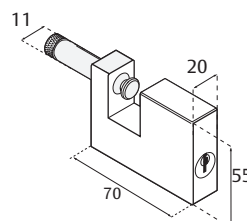

PERNOS
16

SKU	MODELO / FUNCIÓN	EMPAQUE y MÚLTIPLO
4676	TX-110 Hierro	Caja / 6 pzas.

TX - 9

Con **3**
llaves

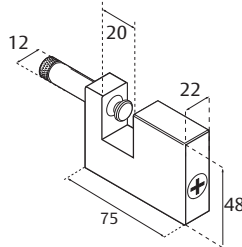

PERNOS
16

SKU	MODELO / FUNCIÓN	EMPAQUE y MÚLTIPLO
2186	TX - 9 Latón	Caja / 6 pzas.

TX - 10

Con **3**
llaves

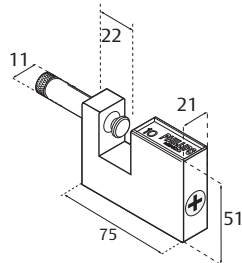

PERNOS
16

SKU	MODELO / FUNCIÓN	EMPAQUE y MÚLTIPLO
2589	TX - 10 AMP Metálico	Caja / 6 pzas.

AS - 9

Con **5**
llaves

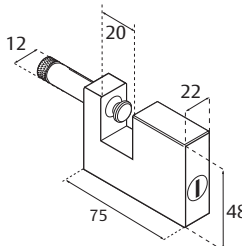

PERNOS
11

SKU	MODELO / FUNCIÓN	EMPAQUE y MÚLTIPLO
2185	AS-9 Latón	Caja / 6 pzas.

AS - 10

Con **5**
llaves

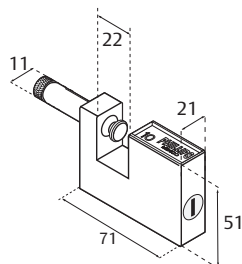

PERNOS
11

SKU	MODELO / FUNCIÓN	EMPAQUE y MÚLTIPLO
2590	AS-10 AMP Metálico	Caja / 6 pzas.

DIGITAL 35



SKU	MODELO / FUNCIÓN	EMPAQUE y MÚLTIPLO
2782	35 Negro	Blister / 6 pzas.
2783	35 Azul	
2781	35 Cromo	

- Combinación única

DIGITAL 40



SKU	MODELO / FUNCIÓN	EMPAQUE y MÚLTIPLO
2785	40 Negro	Blister / 6 pzas.
2786	40 Azul	
2784	40 Cromo	

- Combinación única

TSAP3

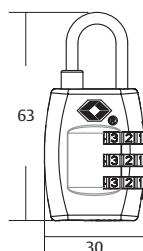

SKU	MODELO / FUNCIÓN	EMPAQUE y MÚLTIPLO
3464	TSAP3 Azul	Blister / 1 pzas.
3473	TSAP3 Rojo	

- Combinación ajustable
- Candado de plástico

TSAM3

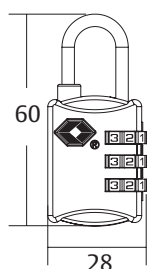

SKU	MODELO / FUNCIÓN	EMPAQUE y MÚLTIPLO
3465	TSAM3 Negro	Blister / 1 pzas.
3466	TSAM3 Natural	

- Combinación ajustable
- Candado metálico

TSAM4

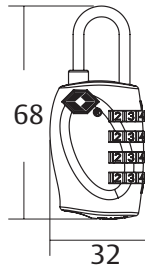

SKU	MODELO / FUNCIÓN	EMPAQUE y MÚLTIPLO
3467	TSAM4 Negro	Blister / 1 pzas.
3468	TSAM4 Natural	

- Combinación ajustable
- Candado metálico

COMBINACIÓN 4

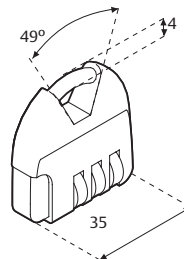

SKU	MODELO / FUNCIÓN	EMPAQUE y MÚLTIPLO
2326	Combinación 4 natural	Blister / 6 pzas.
2320	Combinación 4 negro	
2325	Combinación 4 rojo	

- Combinación ajustable

COMBINACIÓN 11

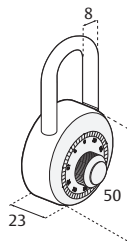

SKU	MODELO / FUNCIÓN	EMPAQUE y MÚLTIPLO
2244	Combinación 11	Blister / 6 pzas.

- Combinación única
- Candado de acero

8

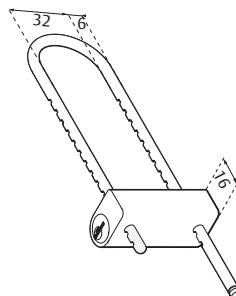
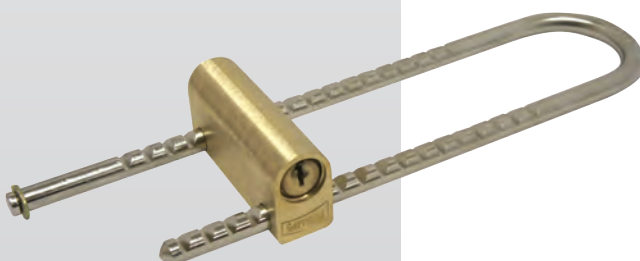

SKU	MODELO / FUNCIÓN	EMPAQUE y MÚLTIPLO
110	Gancho 8	Caja / 1 pza.
253	Gancho 8	Blister / 1 pza.

BICIGAN

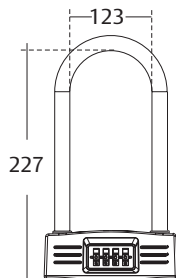

SKU	MODELO / FUNCIÓN	EMPAQUE y MÚLTIPLO
3471	BICIGAN amarillo	Blister / 20 pzas.
3472	BICIGAN negro	

- Combinación ajustable
- Candado de gancho ideal para bicicletas o motocicletas

BICICAB

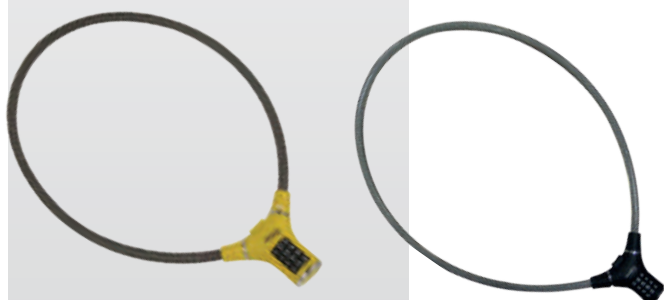

D (Longitud de cable)

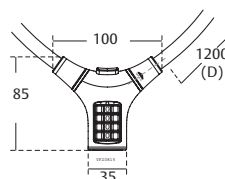

SKU	MODELO / FUNCIÓN	EMPAQUE y MÚLTIPLO
3469	BICICAB amarillo	Blister / 15 pzas.
3470	BICICAB negro	

- Combinación ajustable
- Candado de cable ideal para bicicletas o motocicletas

Candados de combinación para bicicletas y motos

- Candados con cable o gancho extra largo para motocicleta o bicicleta
- Útiles para lugares donde las orejas o portacandados tiene distancias muy amplias entre una y otra
- Combinación de 4 dígitos que se cambian en el momento que se requiera
- El cable es flexible, lo cual permite adecuarse a los espacios (Bicicab)
- Cuerpo metálico protegido con PVC (Bicigan)

Funcionamiento (bicicab):

El código original es 0-0-0-0, y usted tiene que reiniciar su propio número de acuerdo a los siguientes pasos:

1. Con la combinación correcta, empuje hacia arriba (1) como lo indica el dibujo (B).
2. Reinicie la configuración de su clave girando los dígitos al número de su preferencia (2).
3. Regrese el botón de reset a su posición original (1).
4. Presione el botón de cierre y el broche será liberado (3), ahora puede abrir el candado.

La combinación ha sido cambiada. No olvide su nueva combinación.
Para restablecer una nueva combinación, repita desde el paso no. 1





ASSA ABLOY

Línea Económica

CERRADURAS



CERRADURA FRESNO

Características de cerraduras línea económica

- Cerraduras para baño, recámara y entrada
- 200 MIL Aperturas garantizadas
- 20 Años de garantía perillas y 10 años manijas y cerrojos
- Grado 3 ANSI Cumple con norma

(Todas las medidas estan en mm)

PERILLAS CILÍNDRICAS



ASSA ABLOY

GAMMA



PERNOS
50

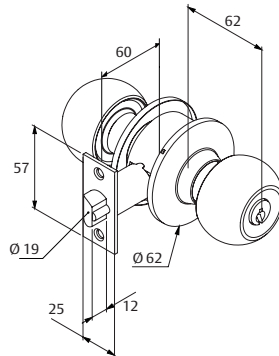

MODELO	FUNCIÓN	ACABADO	SKU	EMPAQUE y MÚLTIPLO		
GAMMA CILÍNDRICA	Baño	Acero Inox.	81917	Caja 20 pzas.		
		Latón Brillante	81111			
		Latón Antiguo	81113			
		Cromo Mate	81107			
	Recámara	Acero Inox.	81911			
		Latón Brillante	81144			
		Latón Antiguo	81146			
	Entrada	Cromo Mate	81140			
		Acero Inox.	81907			
		Latón Brillante	81124			
	GAMMA CILÍNDRICA	Baño	Latón Antiguo		81126	Blister 12 pzas.
			Cromo Mate		81121	
Acero Inox.			81916			
Latón Brillante			81112			
Recámara		Latón Antiguo	81114			
		Cromo Mate	81108			
		Acero Inox.	81910			
		Latón Brillante	81145			
			Latón Antiguo	81147		
			Cromo Mate	81141		

• Cerraduras para baño, recámara y entrada

20

Años de garantía

GRADO 3

Cumple con norma ANSI

200
MITL

Aperturas garantizadas

BRANDY WINE

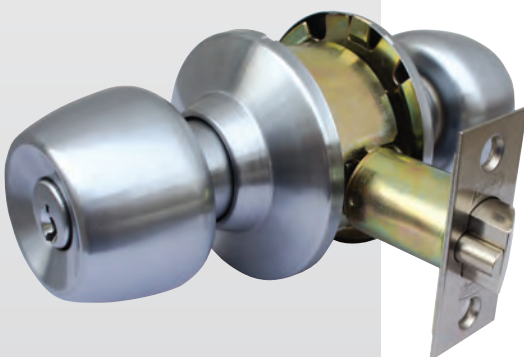

PERNOS
50

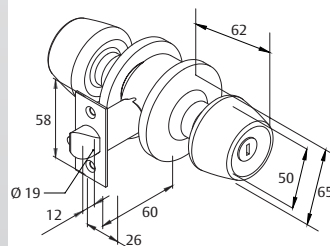

MODELO	FUNCIÓN	ACABADO	SKU	EMPAQUE y MÚLTIPLO		
BRANDY WINE CILÍNDRICA	Baño	Acero Inox.	81708	Caja 20 pzas.		
		Latón Brillante	81704			
		Latón Antiguo	81706			
		Cromo Mate	81702			
	Recámara	Acero Inox.	81716			
		Latón Brillante	81712			
		Latón Antiguo	81714			
	Entrada	Cromo Mate	81710			
		Acero Inox.	81720			
		Latón Brillante	81718			
	BRANDY WINE CILÍNDRICA	Baño	Latón Antiguo		81719	Blister 12 pzas.
			Cromo Mate		81717	
Acero Inox.			81707			
Latón Brillante			81703			
Recámara		Latón Antiguo	81705			
		Cromo Mate	81701			
		Acero Inox.	81715			
		Latón Brillante	81711			
			Latón Antiguo	81713		
			Cromo Mate	81709		

• Cerraduras para baño, recámara y entrada

20

Años de garantía

GRADO 3

Cumple con norma ANSI

200
MITL

Aperturas garantizadas

GAMMA

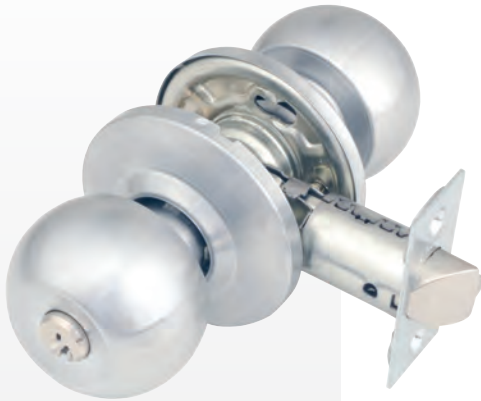

PERNOS
51

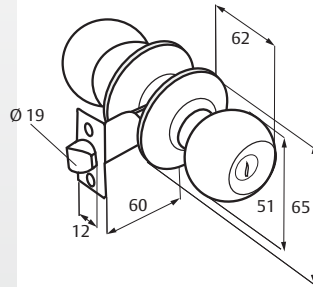

MODELO	FUNCIÓN	ACABADO	SKU	EMPAQUE y MÚLTIPLO
GAMMA TUBULAR	Baño	Latón Brillante	81117	Caja 20 pzas.
		Latón Antiguo	81119	
		Cromo Mate	81115	
	Recámara	Latón Brillante	81154	
		Latón Antiguo	81155	
		Cromo Mate	81153	
GAMMA TUBULAR	Baño	Latón Brillante	81118	Blister 12 pzas.
		Latón Antiguo	81120	
		Cromo Mate	81116	
	Recámara	Latón Brillante	84019	
		Latón Antiguo	84020	
		Cromo Mate	84021	

• Cerraduras para baño y recámara

20
Años de garantía

GRADO 3
Cumple con norma ANSI

200
MITL
Aperturas garantizadas

BRANDY WINE

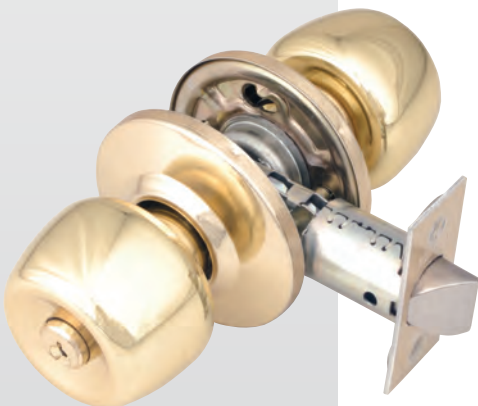

PERNOS
51

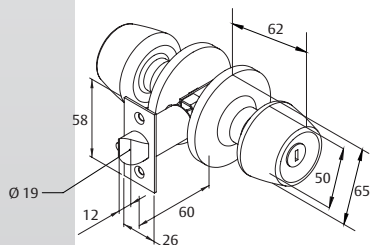

MODELO	FUNCIÓN	ACABADO	SKU	EMPAQUE y MÚLTIPLO
BRANDY WINE TUBULAR	Baño	Latón Brillante	81073	Caja 20 pzas.
		Latón Antiguo	81075	
		Cromo Mate	81071	
	Recámara	Latón Brillante	81092	
		Latón Antiguo	81094	
		Cromo Mate	81091	
BRANDY WINE TUBULAR	Baño	Latón Brillante	81074	Blister 12 pzas.
		Latón Antiguo	81076	
		Cromo Mate	81072	
	Recámara	Latón Brillante	84093	
		Latón Antiguo	81095	
		Cromo Mate	84017	

• Cerraduras para baño y recámara

20
Años de garantía

GRADO 3
Cumple con norma ANSI

200
MITL
Aperturas garantizadas

BARRILETE



PERNOS
51

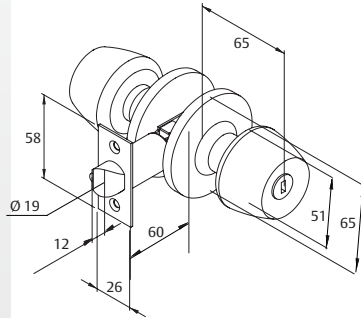

MODELO	FUNCIÓN	ACABADO	SKU	EMPAQUE y MÚLTIPLO
BARRILETE TUBULAR	Baño	Latón Brillante	81257	Caja 20 pzas.
		Latón Antiguo	81256	
		Cromo Mate	81260	
	Recámara	Latón Brillante	81274	
		Latón Antiguo	81273	
		Cromo Mate	81278	
BARRILETE TUBULAR	Baño	Latón Brillante	81258	Blister 12 pzas.
		Latón Antiguo	81259	
		Cromo Mate	81261	
	Recámara	Latón Brillante	81275	
		Latón Antiguo	81276	
		Cromo Mate	81279	

• Cerraduras para baño y recámara

20
Años de garantía

GRADO 3
Cumple con norma ANSI

200
MITL
Aperturas garantizadas

BOLI



PERNOS
51

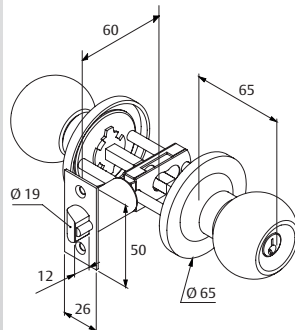

MODELO	FUNCIÓN	ACABADO	SKU	EMPAQUE y MÚLTIPLO
BOLI TUBULAR	Baño	Latón Brillante	81047	Caja 20 pzas.
		Latón Antiguo	81049	
		Cromo Mate	81045	
	Recámara	Latón Brillante	81060	
		Latón Antiguo	81062	
		Cromo Mate	81058	
BOLI TUBULAR	Baño	Latón Brillante	81048	Blister 12 pzas.
		Latón Antiguo	81050	
		Cromo Mate	81046	
	Recámara	Latón Brillante	81061	
		Latón Antiguo	81063	
		Cromo Mate	81059	

• Cerraduras para baño y recámara

20
Años de garantía

GRADO 3
Cumple con norma ANSI

200
MITL
Aperturas garantizadas

NOGAL



PERNOS
50

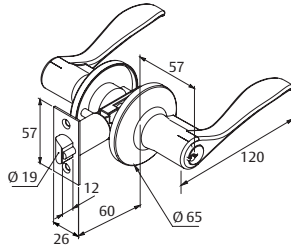

MODELO	FUNCIÓN	ACABADO	SKU	EMPAQUE y MÚLTIPLO
NOGAL TUBULAR	Baño	Latón Brillante	84035	Blister 12 pzas.
		Latón Antiguo	84036	
		Cromo Mate	84034	
NOGAL TUBULAR	Recámara	Latón Brillante	84038	Blister 12 pzas.
		Latón Antiguo	84039	
		Cromo Mate	84037	

• Cerraduras para baño, recámara y entrada

10
Años de garantía

Capacidades especiales

GRADO 3
Cumple con norma ANSI

200
MTL
Aperturas garantizadas

ROBLE



PERNOS
50

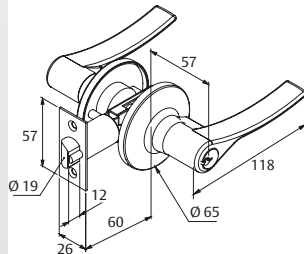

MODELO	FUNCIÓN	ACABADO	SKU	EMPAQUE y MÚLTIPLO
ROBLE TUBULAR	Baño	Latón Brillante	81507	Blister 12 pzas.
		Latón Antiguo	81508	
		Cromo Mate	81506	
ROBLE TUBULAR	Recámara	Latón Brillante	81514	Blister 12 pzas.
		Latón Antiguo	81515	
		Cromo Mate	81513	

• Cerraduras para baño, recámara y entrada

10
Años de garantía

Capacidades especiales

GRADO 3
Cumple con norma ANSI

200
MTL
Aperturas garantizadas

TAMPICO



PERNOS
50

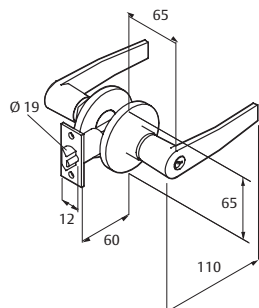

MODELO	FUNCIÓN	ACABADO	SKU	EMPAQUE y MÚLTIPLO
TAMPICO TUBULAR	Baño	Latón Brillante	84043	Blister 12 pzas.
		Latón Antiguo	84044	
		Cromo Mate	84042	
TAMPICO TUBULAR	Recámara	Latón Brillante	84046	Blister 12 pzas.
		Latón Antiguo	84047	
		Cromo Mate	84045	

• Cerraduras para baño, recámara y entrada

10
Años de garantía

Capacidades especiales

GRADO 3
Cumple con norma ANSI

200
MTL
Aperturas garantizadas

SAURA

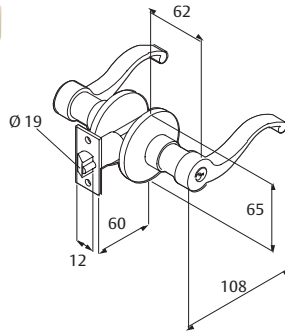

MODELO	FUNCIÓN	ACABADO	SKU	EMPAQUE y MÚLTIPLO
SAURA TUBULAR	Baño	Latón Brillante	81196	Blister 12 pzas.
		Latón Antiguo	81197	
		Cromo Mate	81195	
SAURA TUBULAR	Recámara	Latón Brillante	81199	Blister 12 pzas.
		Latón Antiguo	81200	
		Cromo Mate	81198	

• Cerraduras para baño, recámara y entrada



FRESNO

NUEVA

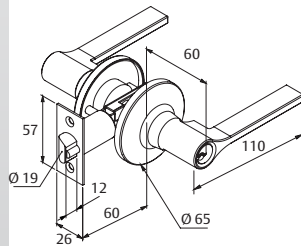

MODELO	FUNCIÓN	ACABADO	SKU	EMPAQUE y MÚLTIPLO
FRESNO TUBULAR	Baño	Latón Brillante	89114	Blister 12 pzas.
		Latón Antiguo	89113	
		Cromo Mate	89117	
FRESNO TUBULAR	Recámara	Latón Brillante	89118	Blister 12 pzas.
		Latón Antiguo	89116	
		Cromo Mate	89115	

• Cerraduras para baño, recámara y entrada



B 260 P

(Llave-Mariposa)



PERNOS
51

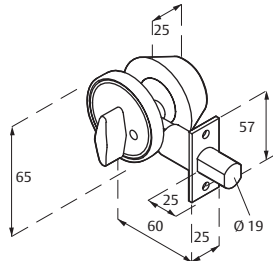

MODELO	FUNCIÓN	ACABADO	SKU	EMPAQUE y MÚLTIPLO
B 260 P	Llave mariposa	Latón Brillante	81214	Blister 12 pzas.
		Latón Antiguo	81215	
		Cromo Mate	81213	
		Acero Inox.	81002	

10
Años de garantía



- Cerrojos para departamentos, casas o bodegas
- Seguridad adicional

B 262 P

(Llave-Llave)



PERNOS
51

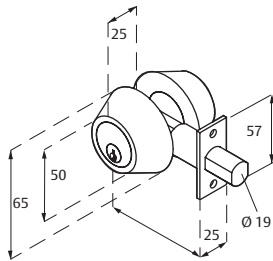

MODELO	FUNCIÓN	ACABADO	SKU	EMPAQUE y MÚLTIPLO
B 262 P	Llave-llave	Latón Brillante	81217	Blister 12 pzas.
		Latón Antiguo	81218	
		Cromo Mate	81216	
		Acero Inox.	81001	

10
Años de garantía



- Cerrojos para departamentos, casas o bodegas
- Seguridad adicional

CERROJO AS

(Llave-Mariposa)

NUEVO



PERNOS
51

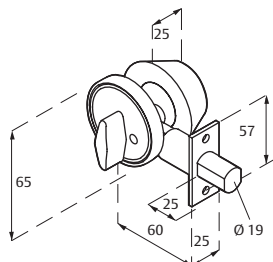

MODELO	FUNCIÓN	ACABADO	SKU	EMPAQUE y MÚLTIPLO
CERROJO AS	Llave mariposa	Latón Antiguo	5350	Blister 12 pzas.
		Latón Brillante	5351	
		Acero Inox.	5352	

- Cerrojos para departamentos, casas o bodegas
- Cerrojo adicional de extra seguridad
- Llaves de puntos AS



10
Años de garantía



CERROJO AS

(Llave-Llave)

NUEVO

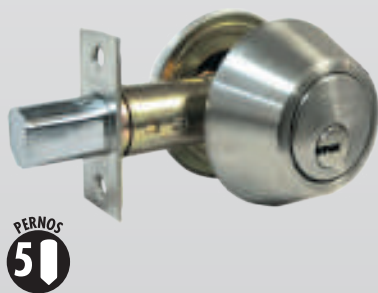

PERNOS
51

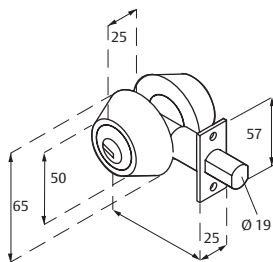

MODELO	FUNCIÓN	ACABADO	SKU	EMPAQUE y MÚLTIPLO
CERROJO AS	Llave-Llave	Latón Antiguo	5347	Blister 12 pzas.
		Latón Brillante	5348	
		Acero Inox.	5349	

- Cerrojos para departamentos, casas o bodegas
- Cerrojo adicional de extra seguridad
- Llaves de puntos AS



10
Años de garantía



BARRILETE TUBULAR



PERNOS
50



MODELO	FUNCIÓN	ACABADO	SKU	EMPAQUE y MÚLTIPLO
BARRILETE TUBULAR	Cerrojo llave-llave Perilla llave-botón	Latón Brillante	81545	Blister 12 pzas.
		Latón Antiguo	81546	
		Cromo Mate	81547	

- Cerraduras para entrada principal
- Abren con la misma llave

10

Años de garantía



Pernos de acero

GRADO 3

Cumple con norma ANSI

GAMMA TUBULAR



PERNOS
50



MODELO	FUNCIÓN	ACABADO	SKU	EMPAQUE y MÚLTIPLO
GAMMA TUBULAR	Cerrojo llave-llave Perilla llave-botón	Latón Brillante	81211	Blister 12 pzas.
		Latón Antiguo	81212	
		Cromo Mate	81210	
GAMMA TUBULAR	Cerrojo llave-Mariposa Perilla llave-botón	Latón Brillante	81208	Blister 12 pzas.
		Latón Antiguo	81209	
		Cromo Mate	81207	

- Cerraduras para entrada principal
- Abren con la misma llave

10

Años de garantía



Pernos de acero

GRADO 3

Cumple con norma ANSI

GAMMA CILÍNDRICA



PERNOS
50



MODELO	FUNCIÓN	ACABADO	SKU	EMPAQUE y MÚLTIPLO
GAMMA CILÍNDRICA	Cerrojo llave-llave Perilla llave-botón	Latón Brillante	81205	Blister 12 pzas.
		Latón Antiguo	81206	
		Cromo Mate	81204	
		Acero Inox.	81230	
GAMMA CILÍNDRICA	Cerrojo llave-Mariposa Perilla llave-botón	Latón Brillante	81202	Blister 12 pzas.
		Latón Antiguo	81203	
		Cromo Mate	81201	
		Acero Inox.	81229	

- Cerraduras para entrada principal
- Abren con la misma llave

10

Años de garantía



Pernos de acero

GRADO 3

Cumple con norma ANSI



ASSA ABLOY

Sobreponer

CERRADURAS

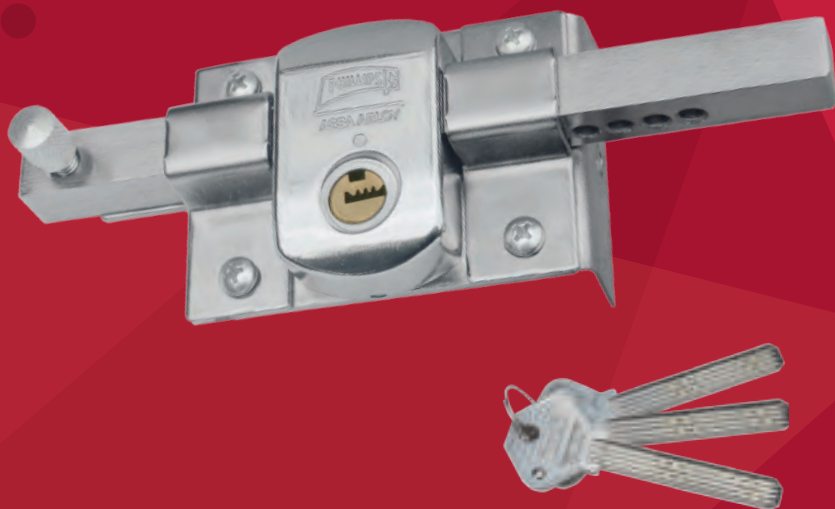

CERRADURA AS-800

Características de cerraduras de sobreponer

- Para puertas metálicas o de madera
- Para tráfico pesado
- De barra para puertas metálicas o de madera
- Para cortinas metálicas

(Todas las medidas estan en mm)

CERRADURAS DE SOBREPONER



715 CL (Clásica)



Cilindro ajustable hasta 2" de espesor de puerta

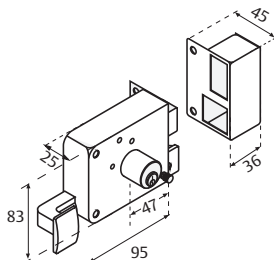

MODELO	FUNCIÓN	EMPAQUE y MÚLTIPLO	ACABADO	SKU
715 CLÁSICA	Derecha	Caja 25 pzas.	Beige	92
	Izquierda			93
715 CLÁSICA	Derecha	Blister 3 pzas.	Beige	460
	Izquierda			461

- Seguridad básica para puertas de abatir

715 IF® Instafácil



Cilindro ensamblado para espesor de puertas hasta 1 1/2"

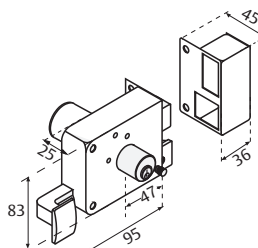

MODELO	FUNCIÓN	EMPAQUE y MÚLTIPLO	ACABADO	SKU
715 IF	Derecha	Caja 25 pzas.	Beige	620
	Izquierda			621
715 IF	Derecha	Blister 3 pzas.	Beige	950
	Izquierda			949

- Seguridad básica para puertas de abatir

715 IF® cromo



Cilindro ensamblado para espesor de puertas hasta 1 1/2"

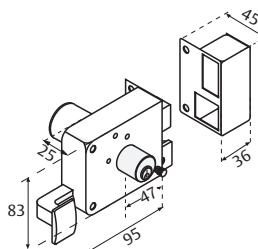

MODELO	FUNCIÓN	EMPAQUE y MÚLTIPLO	ACABADO	SKU
715 Cromo IF	Derecha	Caja 25 pzas.	Cromo	3586
	Izquierda			3587

- Seguridad básica para puertas de abatir

715 LL (Llave larga)



Cilindro ensamblado para espesor de puertas hasta 1 1/2"

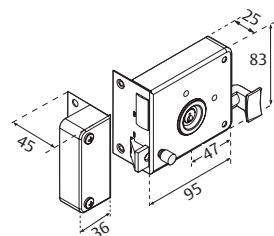

MODELO	FUNCIÓN	EMPAQUE y MÚLTIPLO	ACABADO	SKU
715 IF	Derecha	Caja 10 pzas.	Beige	4643
	Izquierda			4644
	Derecha	Caja 10 pzas.	Negro	4641
	Izquierda			4642

- Seguridad básica para puertas de abatir

COMBO 715 LL-800 L

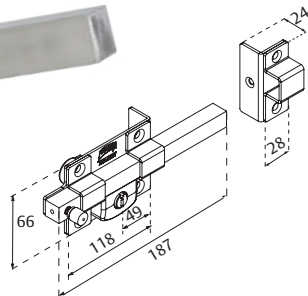
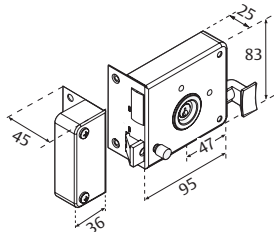

SKU	MODELO	FUNCIÓN	EMPAQUE y MÚLTIPLO	ACABADO
4647	COMBO 715 LL + 800 L	Derecha	Caja 12 pzas.	715 LL Beige
4648		Izquierda		800 L Cromo
4645	COMBO 715 LL + 800 L	Derecha	Caja 12 pzas.	715 LL Negro
4646		Izquierda		800 L Cromo

X-720



Cilindro ajustable hasta 2" de espesor de puerta

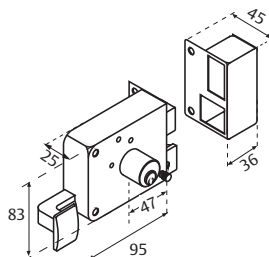

MODELO	FUNCIÓN	EMPAQUE y MÚLTIPLO	ACABADO	SKU
X-720 Clásica	Derecha	Caja 10 pzas.	Beige	1739
	Izquierda			1740

• Extra seguridad para puertas de abatir

X-720 IF®



Cilindro ensamblado para espesor de puertas hasta 1 1/2"

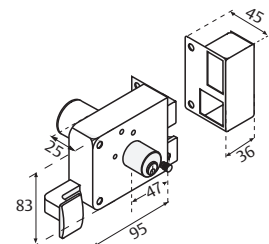

MODELO	FUNCIÓN	EMPAQUE y MÚLTIPLO	ACABADO	SKU
X-720 IF	Derecha	Caja 10 pzas.	Beige	1741
	Izquierda			1742
X-720 IF	Derecha	Blister 10 pzas.	Beige	1749
	Izquierda			1750

• Extra seguridad para puertas de abatir

AS-725



Cilindro ajustable hasta 2" de espesor de puerta

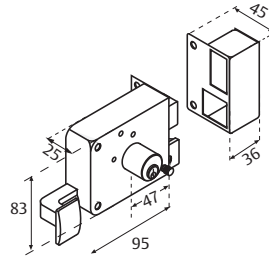

MODELO	FUNCIÓN	EMPAQUE y MÚLTIPLO	ACABADO	SKU
AS-725 Clásica	Derecha	Caja 10 pzas.	Beige	1743
	Izquierda			1744

- Extra seguridad para puertas de abatir

AS-725 IF®



Cilindro ensamblado para espesor de puertas hasta 1 1/2"

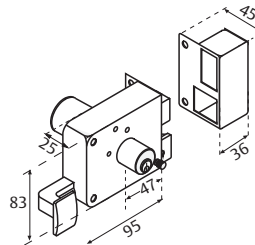

MODELO	FUNCIÓN	EMPAQUE y MÚLTIPLO	ACABADO	SKU
AS-725 IF	Derecha	Caja 10 pzas.	Beige	1753
	Izquierda			1754
AS-725 IF	Derecha	Blister 10 pzas.	Beige	1745
	Izquierda			1746

- Extra seguridad para puertas de abatir

715 MC

(Mariposa-Cilindro)



Cilindro ensamblado para espesor de puertas hasta 1 1/2"

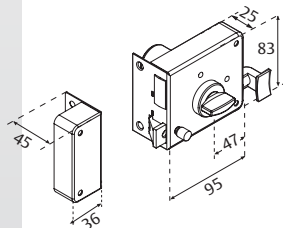

MODELO	FUNCIÓN	EMPAQUE y MÚLTIPLO	ACABADO	SKU
715 MC Clásica	Derecha	Caja 10 pzas.	Beige	4656
	Izquierda			4657
715 MC IF	Derecha	Caja 10 pzas.	Beige	4658
	Izquierda			4659

- Seguridad básica para puertas de abatir

625

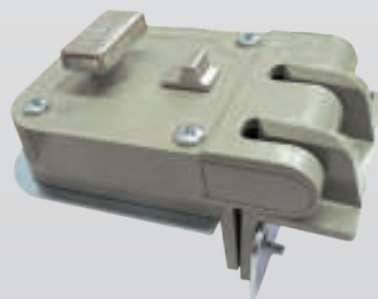

Cilindro ajustable hasta 2" de espesor de puerta

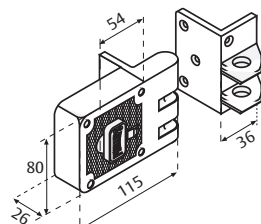

MODELO	FUNCIÓN	EMPAQUE y MÚLTIPLO	ACABADO	SKU
625 Mariposa-Cilindro	Derecha	Caja 10 pzas.	Beige	82
	Izquierda			83
625 Mariposa-Cilindro	Derecha	Blister 12 pzas.	Beige	456
	Izquierda			457

- Para puertas de abatir y corredizas, incluye placa metálica soldable

625 DC

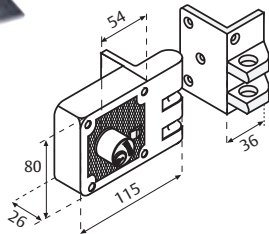

Cilindro ajustable hasta 2"



MODELO	FUNCIÓN	EMPAQUE y MÚLTIPLO	ACABADO	SKU
625 DC Clásica	Derecha	Caja 10 pzas.	Beige	84
	Izquierda			85
625 DC Clásica	Derecha	Blister 12 pzas.	Beige	458
	Izquierda			459

- Para puertas de abatir y corredizas, incluye placa metálica soldable

625 IF® DC

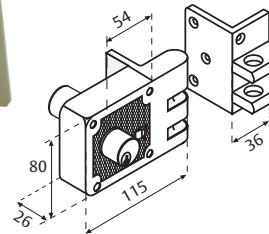
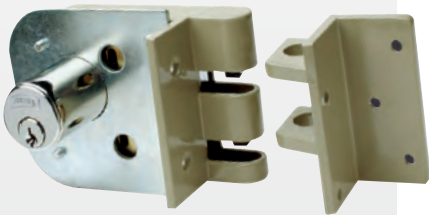

Cilindro ensamblado para espesor de puertas hasta 1 1/2"



MODELO	FUNCIÓN	EMPAQUE y MÚLTIPLO	ACABADO	SKU
625 DC IF	Derecha	Caja 10 pzas.	Beige	2201
	Izquierda			2202
625 DC IF	Derecha	Blister 12 pzas.	Beige	2203
	Izquierda			2204

- Para puertas de abatir y corredizas, incluye placa metálica soldable

AS-625

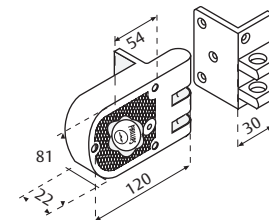
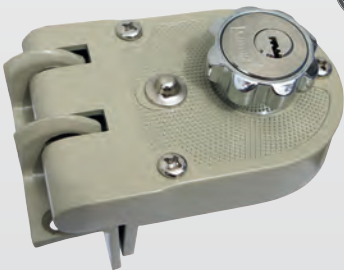

Cilindro ajustable hasta 2" de espesor de puerta

MODELO	FUNCIÓN	EMPAQUE y MÚLTIPLO	ACABADO	SKU
AS-625 Clásica	Derecha	Caja 20 pzas.	Beige	2536
	Izquierda			2537

- Extra seguridad para puertas de abatir y corredizas

620

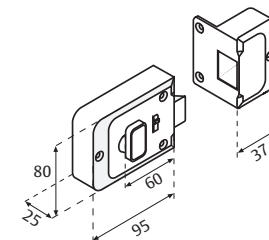

Cilindro ajustable hasta 2" de espesor de puerta



MODELO	FUNCIÓN	EMPAQUE y MÚLTIPLO	ACABADO	SKU
620	Der. / Izq.	Caja 4 pzas.	Beige	1417

- Picaporte de golpe con mariposa

CERRADURAS DE SOBREPONER



675



Cilindro ajustable hasta 2" de espesor de puerta

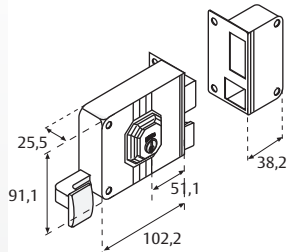

MODELO	FUNCIÓN	EMPAQUE y MÚLTIPLO	ACABADO	SKU
675 Clásica	Derecha	Caja 6 pzas.	Beige	88
	Izquierda			89

- Con picaporte y cerrojo de latón sólido

650 PS



Cilindro ajustable hasta 2" de espesor de puerta

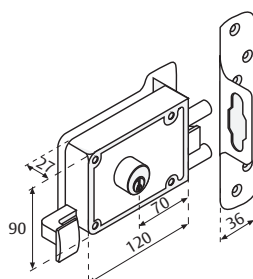

MODELO	FUNCIÓN	EMPAQUE y MÚLTIPLO	ACABADO	SKU
650 PS Clásica	Derecha	Caja 6 pzas.	Beige	86
	Izquierda			87

- Para puertas de abatir, incluye placa metálica soldable

AS-2000 IF

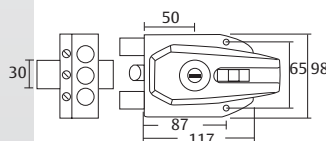

MODELO	FUNCIÓN	EMPAQUE y MÚLTIPLO	ACABADO	SKU
AS-2000 IF	Der. / Izq.	Caja 1 pza.	Beige	4685
			Negro	4720

- Entrada principal, dos cerrojos de acero (bulones) y un picaporte

AS-3000 IF

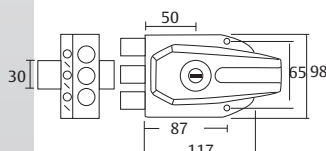

MODELO	FUNCIÓN	EMPAQUE y MÚLTIPLO	ACABADO	SKU
AS-3000 IF	Der. / Izq.	Caja 1 pza.	Beige	4686
			Negro	4721

- Entrada principal, tres cerrojos de acero (bulones)

HS-4000-AS 6

(Clásica)



Cilindro ajustable hasta 2" de espesor de puerta

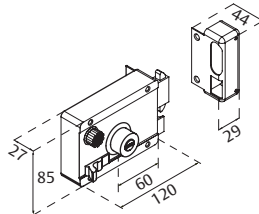

MODELO	FUNCIÓN	EMPAQUE y MÚLTIPLO	ACABADO	SKU
HS-4000 AS6 clásica	Derecha	Caja 1 pza.	Acero Inox	2654
	Izquierda			2655

- Cerrojo tipo ancla
- Caja de acero inoxidable

HS-4000-AS 6 IF®



Cilindro ensamblado para espesor de puertas hasta 1 1/2"

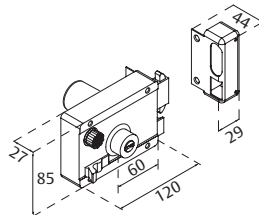

MODELO	FUNCIÓN	EMPAQUE y MÚLTIPLO	ACABADO	SKU
HS-4000 AS6 IF	Derecha	Caja 1 pza.	Acero Inox	2660
	Izquierda			2661

- Cerrojo tipo ancla
- Caja de acero inoxidable

HS-4100-AS 6

(Clásica)



Cilindro ajustable hasta 2" de espesor de puerta

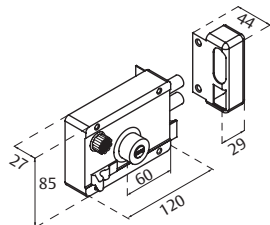

MODELO	FUNCIÓN	EMPAQUE y MÚLTIPLO	ACABADO	SKU
HS-4100 AS6 clásica	Derecha	Caja 1 pza.	Acero Inox	2656
	Izquierda			2657

- Cerrojo de doble barra (bulones)
- Caja de acero inoxidable

HS-4100-AS 6 IF®



Cilindro ensamblado para espesor de puertas hasta 1 1/2"

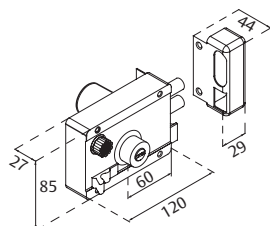

MODELO	FUNCIÓN	EMPAQUE y MÚLTIPLO	ACABADO	SKU
HS-4100 AS6 IF	Derecha	Caja 1 pza.	Acero Inox	2662
	Izquierda			2663

- Cerrojo de doble barra (bulones)
- Caja de acero inoxidable



CERRADURAS DE SOBREPONER



HS-4200-AS 6

(Clásica)



Cilindro ajustable hasta 2" de espesor de puerta

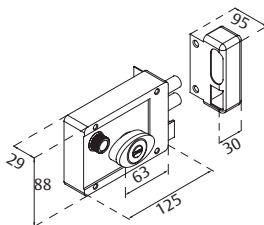

MODELO	FUNCIÓN	EMPAQUE y MÚLTIPLO	ACABADO	SKU
HS-4200 AS6 clásica	Derecha	Caja 1 pza.	Acero Inox	2658
	Izquierda			2659

- Cerrojo de doble barra (bulones), con cierre automático

HS-4200-AS 6 IF®



Cilindro ensamblado para espesor de puertas hasta 1 1/2"

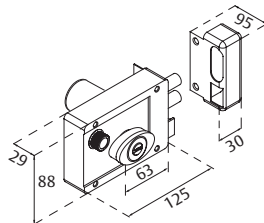

MODELO	FUNCIÓN	EMPAQUE y MÚLTIPLO	ACABADO	SKU
HS-4200 AS6 IF	Derecha	Caja 1 pza.	Acero Inox	2664
	Izquierda			2665

- Cerrojo de doble barra (bulones), con cierre automático
- Caja de acero inoxidable



CERRADURAS DE SOBREPONER DE ALTA SEGURIDAD

USOS:

- Cerraduras de sobreponer para puertas abatibles metálicas o de madera
- Disponibles para puertas izquierdas y derechas en versión Clásica e Instafácil®

CARACTERÍSTICAS:

- Cilindros y cuerpos de latón de extra seguridad
- Se surten con 6 llaves niqueladas de latón
- Fácil inversión de resbalón
- Backset de 60 mm
- Para instalación en puertas de 35 a 55 mm de espesor
- Incluye placas soldables para su instalación
- Caja y contra de acero inoxidable para uso rudo
- Cerraduras de alta seguridad con seis pernos de carrete lo que dificulta la apertura con Ganzúa
- Con llave de puntos lo que dificulta la violación con ganzúa

**PRODUCTOS
NUEVOS**

- Cerraduras de sobreponer de barra
- Cerrojo de acero sólido
- Rápida y sencilla instalación
- Soldable
- Cinco pernos de carrete

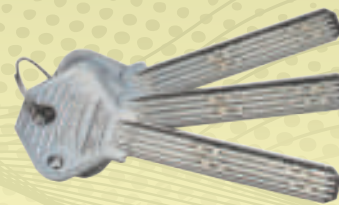

Llave de puntos, dificulta la apertura con ganzúa

AS 800 FIJA/LIBRE

NUEVA

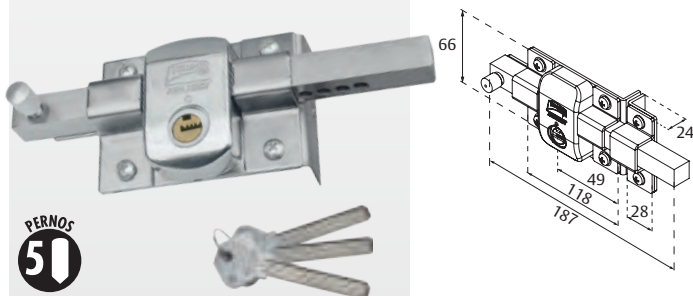

PERNOS
51

MODELO	FUNCIÓN	EMPAQUE y MÚLTIPLO	ACABADO	SKU
AS 800 FIJA	Derecha	Caja 10 pzas.	Cromo	5374
	Izquierda			5383
AS 800 FIJA	Derecha	Blister 12 pzas.	Cromo	5378
	Izquierda			5377
AS 800 LIBRE	Derecha	Caja 10 pzas.	Cromo	5385
	Izquierda			5384
AS 800 LIBRE	Derecha	Blister 12 pzas.	Cromo	5382
	Izquierda			5381

- Cerrojo de acero sólido con carrera de 78 mm

AS 800 CH

NUEVA



PERNOS
51

MODELO	FUNCIÓN	EMPAQUE y MÚLTIPLO	ACABADO	SKU
AS 800 CH	Derecha	Caja 10 pzas.	Cromo	5380
	Izquierda			5379

- Cerrojo de acero sólido corto con carrera de 28.6 mm

AS 775

NUEVA

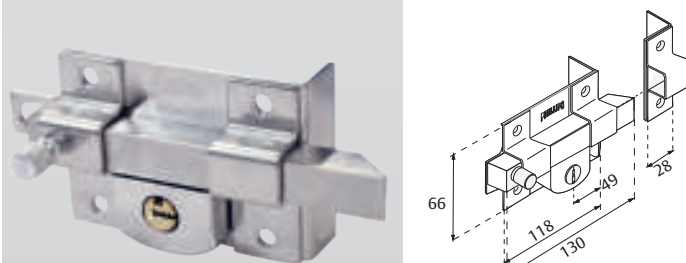

PERNOS
51

MODELO	FUNCIÓN	EMPAQUE y MÚLTIPLO	ACABADO	SKU
AS 775	Derecha	Caja 6 pzas.	Cromo	5446
	Izquierda			5447
AS 775	Derecha	Caja 12 pzas.	Cromo	5444
	Izquierda			5445

- Cerrojo con picaporte integrado y cierre de golpe

AS 875 FIJA/LIBRE

NUEVA



PERNOS 50

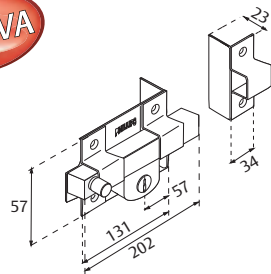

MODELO	FUNCIÓN	EMPAQUE y MÚLTIPLO	ACABADO	SKU
AS 875 FIJA	Derecha	Caja 4 pzas.	Cromo	5439
	Izquierda			5440
AS 875 LIBRE	Derecha	Caja 4 pzas.	Cromo	5441
	Izquierda			5442

- Cerrojo robusto de acero sólido con carrera de 78.6 mm

AS 825

NUEVA



PERNOS 50

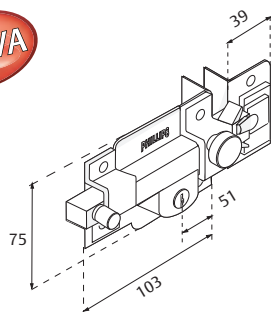

MODELO	FUNCIÓN	EMPAQUE y MÚLTIPLO	ACABADO	SKU
AS 825	Derecha	Caja 6 pzas.	Cromo	5435
	Izquierda			5436

- Cerrojo sólido con 2 uñas que actúan como picaporte

AS 850

NUEVA



PERNOS 50

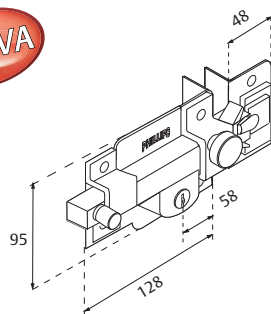

MODELO	FUNCIÓN	EMPAQUE y MÚLTIPLO	ACABADO	SKU
AS 850	Derecha	Caja 4 pzas.	Cromo	5437
	Izquierda			5438

- Cerrojo sólido para uso rudo con 2 uñas que actúan como picaporte

AS 745

NUEVA



PERNOS 50

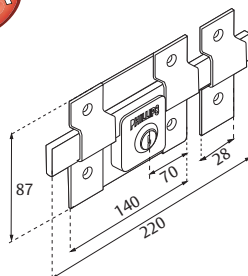

MODELO	FUNCIÓN	EMPAQUE y MÚLTIPLO	ACABADO	SKU
745	Der./Izq.	Caja 6 pzas.	Natural	5443

- Cerrojo de acero sólido con llave AS larga para cortinas metálicas

AS 740

NUEVA

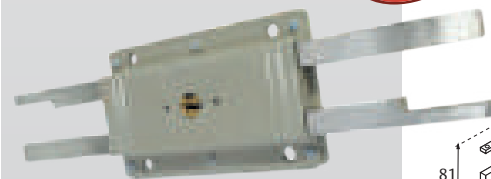

PERNOS 50

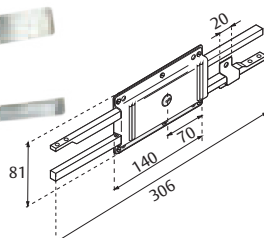

MODELO	FUNCIÓN	EMPAQUE y MÚLTIPLO	ACABADO	SKU
740	Der./Izq.	Caja 6 pzas.	Beige	5448

- Dos cerrojos de acero sólido con mecanismo de cremallera que se extienden en direcciones opuestas, ideal para cortinas metálicas

CERRADURAS DE SOBREPONER DE BARRA



800 FIJA/LIBRE

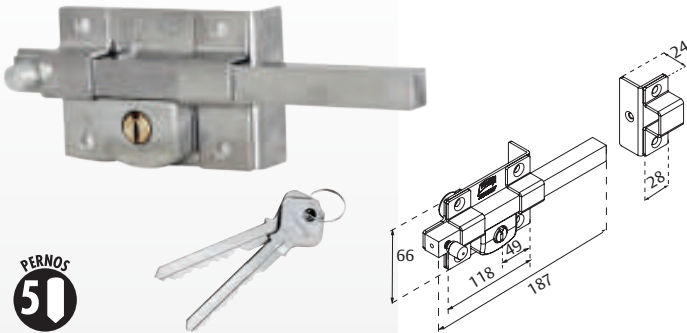

MODELO	FUNCIÓN	EMPAQUE y MÚLTIPLO	ACABADO	SKU
800 F	Derecha	Caja 10 pzas.	Cromo	97
	Izquierda			98
800 F	Derecha	Blister 12 pzas.	Cromo	466
	Izquierda			467
800 L	Derecha	Caja 10 pzas.	Cromo	99
	Izquierda			100
	Derecha		Latón Ant.	1401
	Izquierda			1402
800 L	Derecha	Blister 12 pzas.	Cromo	464
	Izquierda			465

• Cerrojo de acero sólido con carrera de 78 mm

800 CH

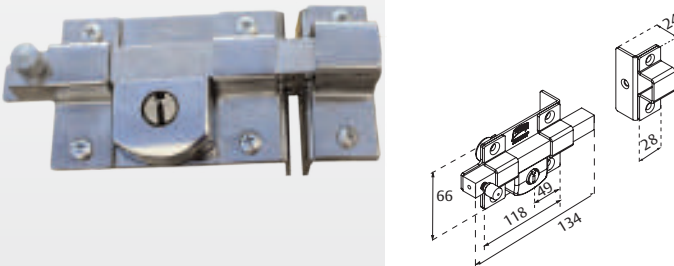

MODELO	FUNCIÓN	EMPAQUE y MÚLTIPLO	ACABADO	SKU
800 CH	Derecha	Caja 10 pzas.	Cromo	1480
	Izquierda			1481

800 MAX

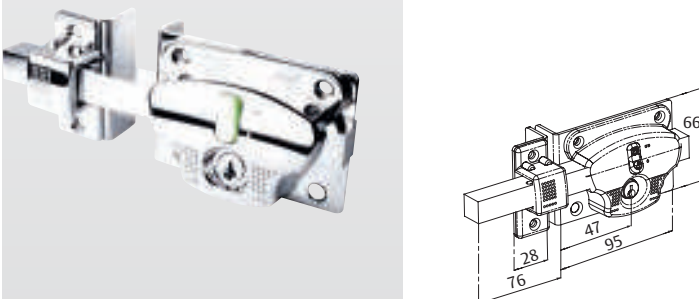

MODELO	FUNCIÓN	EMPAQUE y MÚLTIPLO	ACABADO	SKU
800 MAX	Fija	Caja 10 pzas.	Cromo	3149
	Libre			3150

• Cerrojo reversible con botón luminiscente

X-900 MAX

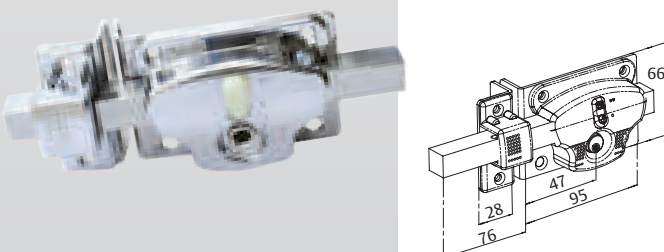

MODELO	FUNCIÓN	EMPAQUE y MÚLTIPLO	ACABADO	SKU
X-900 MAX	Fija	Caja 10 pzas.	Cromo	3333

• Cerrojo reversible con llave tetra y botón luminiscente

X-900

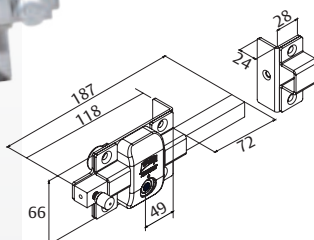

MODELO	FUNCIÓN	EMPAQUE y MÚLTIPLO	ACABADO	SKU
X-900	Derecha	Caja 10 pzas.	Cromo	411
	Izquierda			410
X-900	Derecha	Blister 12 pzas.	Cromo	468
	Izquierda			469

- Cerrojo de acero sólido 78 mm con mecanismo tetra

775

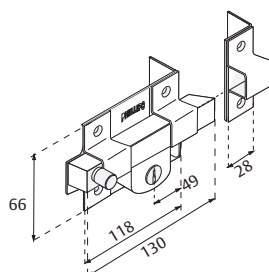

MODELO	FUNCIÓN	EMPAQUE y MÚLTIPLO	ACABADO	SKU
775	Derecha	Caja 6 pzas.	Cromo	95
	Izquierda			96

- Cerrojo con picaporte integrado y cierre de golpe

875 FIJA/LIBRE

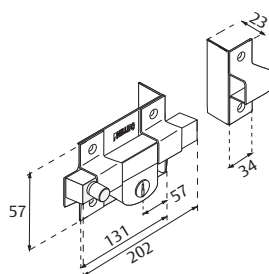

MODELO	FUNCIÓN	EMPAQUE y MÚLTIPLO	ACABADO	SKU
875 FIJA	Derecha	Caja 4 pzas.	Cromo	105
	Izquierda			106
875 LIBRE	Derecha	Caja 4 pzas.	Cromo	107
	Izquierda			108

- Cerrojo robusto de acero sólido con carrera de 78.6 mm

825

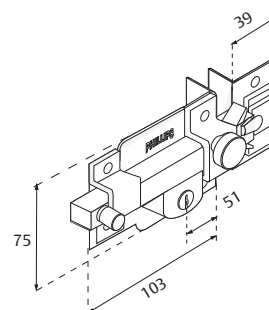

MODELO	FUNCIÓN	EMPAQUE y MÚLTIPLO	ACABADO	SKU
825	Derecha	Caja 6 pzas.	Cromo	101
	Izquierda			102

- Cerrojo sólido con 2 uñas que actúan como picaporte

850

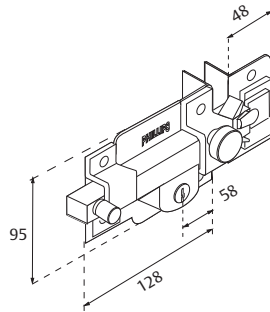

MODELO	FUNCIÓN	EMPAQUE y MÚLTIPLO	ACABADO	SKU
850	Derecha	Caja 4 pzas.	Cromo	103
	Izquierda			104

- Cerrojo sólido para uso rudo con 2 uñas que actúan como picaporte

X-750

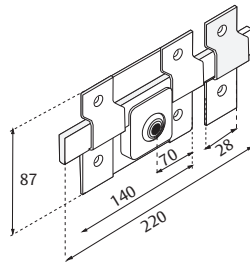
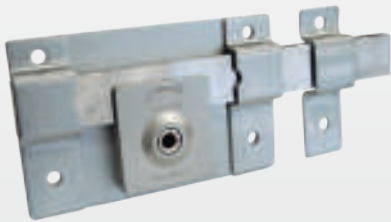

MODELO	FUNCIÓN	EMPAQUE y MÚLTIPLO	ACABADO	SKU
X-750	Der./Izq.	Caja 6 pzas.	Natural	574

- Cerrojo de acero sólido de extra seguridad para cortinas metálicas

745

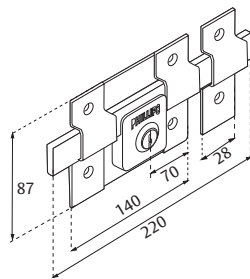

MODELO	FUNCIÓN	EMPAQUE y MÚLTIPLO	ACABADO	SKU
745	Der./Izq.	Caja 6 pzas.	Natural	414

- Cerrojo de acero sólido con llave ph52 larga para cortinas metálicas

740

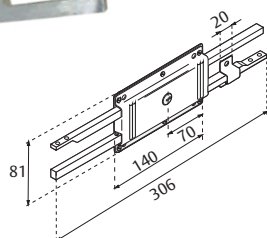

MODELO	FUNCIÓN	EMPAQUE y MÚLTIPLO	ACABADO	SKU
740	Der./Izq.	Caja 6 pzas.	Beige	94

- Dos cerrojos de acero sólido con mecanismo de cremallera que se extienden en direcciones opuestas, ideal para cortinas metálicas

700

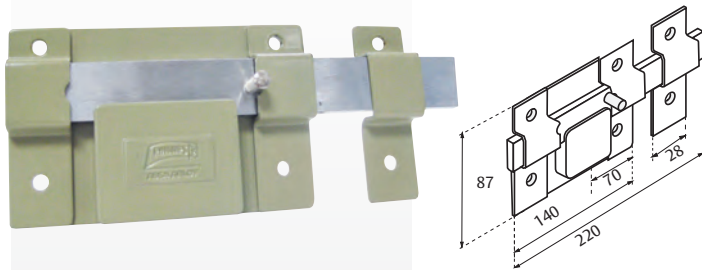

MODELO	FUNCIÓN	EMPAQUE y MÚLTIPLO	ACABADO	SKU
700	Der./Izq.	Caja 6 pzas.	Beige	90

- Cerrojo de acero sólido de 6 pasos, ideal para cortinas metálicas

700 DC

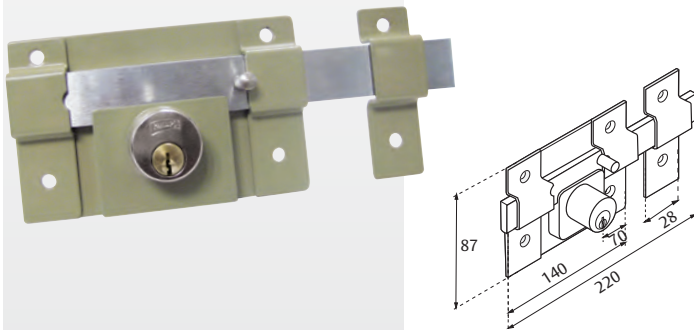

MODELO	FUNCIÓN	EMPAQUE y MÚLTIPLO	ACABADO	SKU
700 DC	Der./Izq.	Caja 6 pzas.	Beige	91

- Cerrojo de acero sólido de 6 pasos que opera como pasador por el interior, ideal para cortinas metálicas

150 MM R

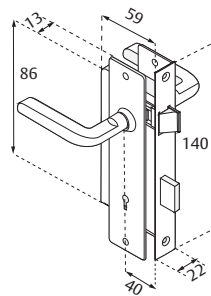

MODELO	FUNCIÓN	EMPAQUE y MÚLTIPLO	ACABADO	SKU
150 MM R	Racámara	Caja 6 pzas.	Cromo	25

- Cerraduras de embutir para recámara y baño

150 MM B

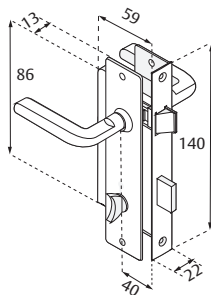

MODELO	FUNCIÓN	EMPAQUE y MÚLTIPLO	ACABADO	SKU
150 MMB	Baño	Caja 6 pzas.	Cromo	27

- Cerraduras de embutir para recámara y baño

500 MM

500 JM

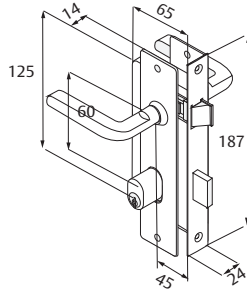

PERNO
51

MODELO	FUNCIÓN	EMPAQUE y MÚLTIPLO	ACABADO	SKU
500 MM	Racámara	Caja 6 pzas.	Cromo	54
500 JM	Entrada			55

• Cerraduras de embutir para entrada principal

X-1000

EXTRA SEGURIDAD

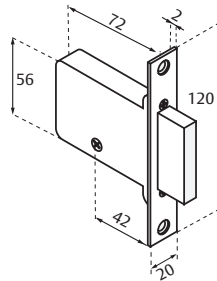

Con **3** llaves



PERNOS
61

MODELO	FUNCIÓN	EMPAQUE y MÚLTIPLO	ACABADO	SKU
X-1000	Der. / Izq.	Caja 10 pzas.	Cromo	570
			Latón	931
			Latón ant.	930

• Cerradura auxiliares de extra seguridad

X-1000 BOLT

EXTRA SEGURIDAD

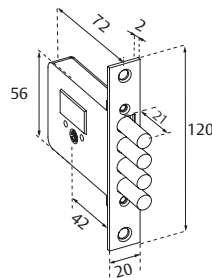

Con **3** llaves



PERNOS
61

MODELO	FUNCIÓN	EMPAQUE y MÚLTIPLO	ACABADO	SKU
X-1000 BOLT	Der. / Izq.	Caja 10 pzas.	Cromo	4817
			Latón	4816

• Cerradura auxiliares de extra seguridad con 4 bulones

X-1100

EXTRA SEGURIDAD

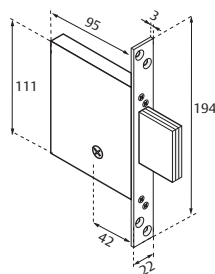
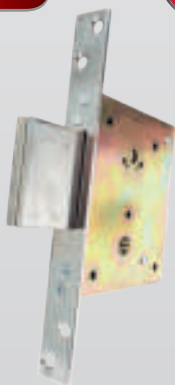

Con **3** llaves



PERNOS
61

MODELO	FUNCIÓN	EMPAQUE y MÚLTIPLO	ACABADO	SKU
X-1100	Der. / Izq.	Caja 10 pzas.	Cromo	571
			Latón	933
			Latón ant.	932

• Cerraduras auxiliares de extra seguridad

TABLA DE APLICACIONES

PRODUCTO					
	Puerta de entrada y garage	Puerta de entrada principal	Puerta de entrada principal	Puerta de entrada principal	Puerta corrediza
	ACERO	MADERA	ACERO	ACERO	ACERO
Cerr. 715/715 MC/715 LL					
Cerr. combo 715 IF LL-800 L					
Cerr. X-720					
Cerr. AS-725					
Cerr. 620					
Cerr. 650 PS					
Cerr. 675					
Cerr. 715 Herrero					
Cerr. 715 Elektron					
Cerr. HS 4000 AS-6					
Cerr. HS 4100 AS-6					
Cerr. HS 4200 AS-6					
Cerr. 625/625 DC/625IF DC					
Cerr. AS-625					
Cerr. 700/ 700DC/ 740/ 745/ X-750					
Cerr. X-900					
Cerr. X-900 MAX					
Cerr. 800					
Cerr. 800 MAX					
Cerr. 800 CH					
Cerr. 850/825					
Cerr. 875					
Cerr. 775					
Cerr. AS-2000 / AS-3000					
Cerr. 150					
Cerr. 500					
Cerr. X-1000 / X-100 BOLT					
Cerr. X-1100					
Cerr. 321					
Bisagra 1500					
Cierrapuertas 1402/1404					
Cierrapuertas 1406					
Línea Económica					



ASSA ABLOY

Electromecánicas

CERRADURAS



CERRADURA 321 DCB

Características de cerraduras electromecánicas

- Control de acceso a distancia
- Portero eléctrico
- Kits
- Controles, receptores y transformadores

(Todas las medidas estan en mm)

321 DC (sin botón)

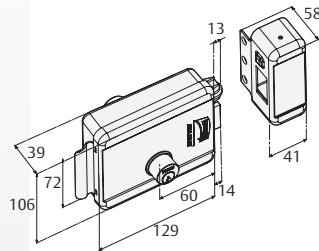

PERNOS
50

MODELO	FUNCIÓN	EMPAQUE y MÚLTIPLO	ACABADO	SKU
321 DC S/BOTÓN	Derecha	Caja 1 pza.	Beige	3411
	Izquierda			3418

- Para apertura de puertas a distancia, se adapta al interfón y/o video portero para controlar el acceso y salida desde un punto específico

321 DCB (con botón)

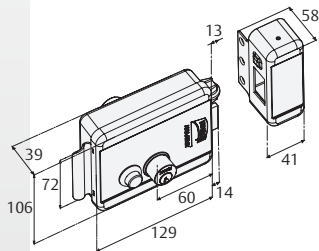

PERNOS
50

MODELO	FUNCIÓN	EMPAQUE y MÚLTIPLO	ACABADO	SKU
321 DCB C/BOTÓN	Derecha	Caja 1 pza.	Beige	3410
	Izquierda			3419

- Para apertura de puertas a distancia, se adapta al interfón y/o video portero para controlar el acceso y salida desde un punto específico

KIT 321



PERNOS
50

MODELO	FUNCIÓN	EMPAQUE y MÚLTIPLO	ACABADO	SKU
KIT 321	Derecha	Blister 1 pza.	Beige	3420
	Izquierda			3421

- Para apertura de puertas a distancia

Portero Eléctrico 321



PERNOS
50

MODELO	FUNCIÓN	EMPAQUE y MÚLTIPLO	ACABADO	SKU
PORTERO ELÉCTRICO 321	Derecha	Caja 1 pza.	Beige	4791
	Izquierda			4803

- Para apertura de puertas con contro remoto con alcance hasta 50 mts

KIT 310



MODELO	FUNCIÓN	EMPAQUE y MÚLTIPLO	ACABADO	SKU
KIT 310	Der. / Izq.	Blister 1 pza.	Cromo	3422

- Para apertura de puertas a distancia, adaptable a casi todas las cerraduras con resbalón, ideal para cerraduras de embutir y sobreponer

TRANSFORMADOR



Mod. HA48N8250
IDEAL PARA CERRADURA
321 Y CONTRA 310

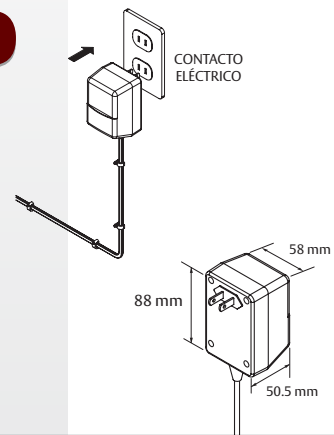

Entrada: 127 Vca 60 Hz 0.15 A
Salida: 12 Vca 60 Hz 1.2 A
Temperatura de operación:
-20°C a +40°C
Temperatura de almacenamiento:
-20°C a +80°C
Dimensiones:
88 x 58 x 50.5 mm
Terminal a cable desforre 10 mm

MODELO	EMPAQUE y MÚLTIPLO	SKU
Mod. HA48N8250	Caja / 1 pza.	4666

RECEPTOR / CONTROL REMOTO

(juego)

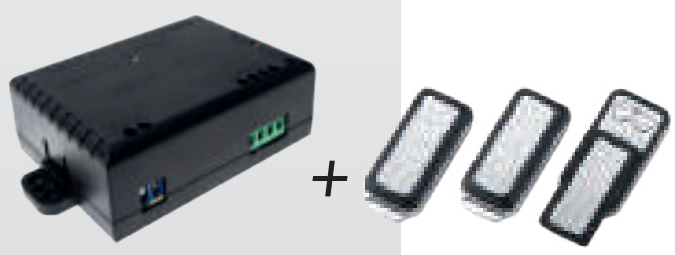

MODELO	EMPAQUE y MÚLTIPLO	SKU
Receptor con transformador integrado y 3 controles	Caja / 1 pza.	5226

- Recibe hasta 30 controles remotos

CONTROL REMOTO

(individual)



MODELO	EMPAQUE y MÚLTIPLO	SKU
Control remoto	Caja / 1 pza.	4778

- Para portero eléctrico 321

SOLENOIDE



MODELO	FUNCIÓN	EMPAQUE y MÚLTIPLO	SKU
Solenoid	Derecha	Caja 1 pza.	3476

Solenoid para cerradura eléctrica, alimentación de 12 Vcc - 12 Vca.

SOLENOIDE

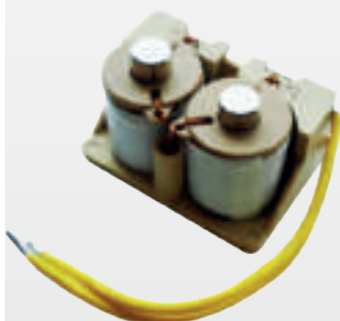

MODELO	FUNCIÓN	EMPAQUE y MÚLTIPLO	SKU
Solenoid	Izquierda	Caja 1 pza.	3477

Solenoid para cerradura eléctrica, alimentación de 12 Vcc - 12 Vca.

CONTRA ELÉCTRICA 310

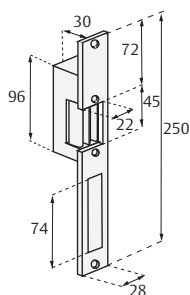

MODELO	FUNCIÓN	EMPAQUE y MÚLTIPLO	ACABADO	SKU
CONTRA ELÉCTRICA 310	Der. / Izq.	Caja 1 pza.	Cromo	1460
			Latón	1461

- Contra eléctrica para apertura de puertas a larga distancia ideal para cerraduras de embutir y sobreponer

CONTRA 310



Adaptador para contra 310

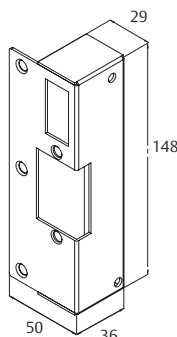

MODELO	FUNCIÓN	EMPAQUE y MÚLTIPLO	ACABADO	SKU
CONTRA 310	Derecha	Caja 1 pza.	Beige	3478
	Izquierda			3479

- Este adaptador te permite cambiar la contra de una cerradura tipo 715 con la finalidad de hacerla eléctrica y tener aperturas a distancia



ASSA ABLOY

Mueble

CERRADURAS



CERRADURA 80

Características de cerraduras de mueble

- Para muebles metálicos y de madera
- Para puertas corredizas, closets y vitrinas
- Para muebles de oficina

(Todas las medidas estan en mm)

TABLA DE USOS MÁS COMUNES

Cerradura	Puerta							
Mod. 21	B							
Mod. 23	B							
Mod. 24	B							
Mod. 32	B							
Mod. 50	B		P	G				
Mod. 60	B		P	G				
Mod. 55	B		P	G				
Mod. 65	B		P	G				
Mod. 53	NA							
Mod. 63	NA							
Mod. 42	B							
Mod. 72	C							
Mod. 80	C							
Mod. 200	C							
Mod. 250 CH	B							
Mod. 250	B							
Mod. 110	B							
Mod. 120	B							
Mod. 130	B			G				
Mod. 170	C							
Mod. 180	B							

P= Paleta



C= Puerta corrediza



Recomendado

G= Gancho



B= Puerta batiente

21

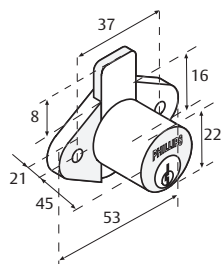

MODELO	FUNCIÓN	EMPAQUE y MÚLTIPLO	ACABADO	SKU
21	Der. / Izq.	Caja 12 pzas.	Cromo	1
			Latón	2
		Blister 12 pzas.	Cromo	246
			Latón	247

- Para cajones, muebles y escritorios. Cerrojo de acción vertical

24

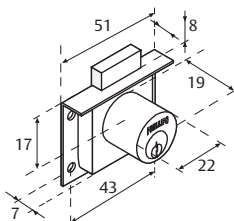
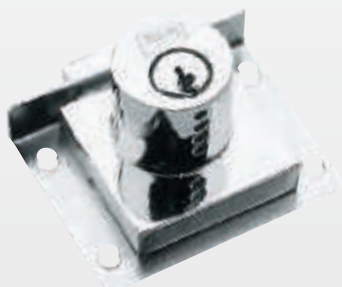

MODELO	FUNCIÓN	EMPAQUE y MÚLTIPLO	ACABADO	SKU
24	Der. / Izq.	Caja 12 pzas.	Cromo	5
			Latón	6

- Para cajones, muebles y escritorios. Cerrojo de acción vertical

32

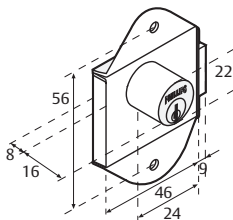

MODELO	FUNCIÓN	EMPAQUE y MÚLTIPLO	ACABADO	SKU
32	Der. / Izq.	Caja 12 pzas.	Cromo	7
			Latón	8

- Para armarios, lockers, gabinetes y muebles. Cerrojo de acción horizontal.

50

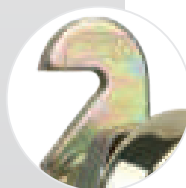

Gancho

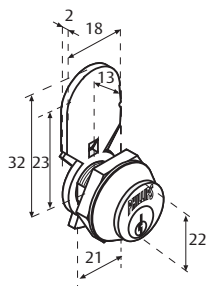

MODELO	FUNCIÓN	EMPAQUE y MÚLTIPLO	ACABADO	SKU
50	Der. / Izq.	Caja 12 pzas.	Cromo	12
			Latón	14

- Para cajones, muebles y escritorios. Cerrojo de acción vertical

Incluyen paleta y gancho en el mismo empaque

60

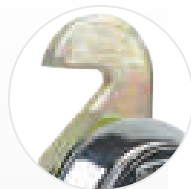

Gancho

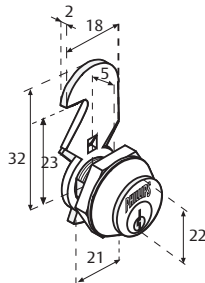

Incluyen paleta y gancho en el mismo empaque

MODELO	FUNCIÓN	EMPAQUE y MÚLTIPLO	ACABADO	SKU
60	Der. / Izq.	Caja 12 pzas.	Cromo	16
			Latón	18

• Para cajones, muebles y escritorios. Cerrojo de acción vertical

55



Gancho

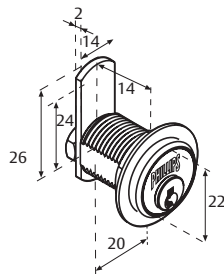

Incluyen paleta y gancho en el mismo empaque

MODELO	FUNCIÓN	EMPAQUE y MÚLTIPLO	ACABADO	SKU
55	Der. / Izq.	Caja 12 pzas.	Cromo	1234
			Latón	1236

• Para cajones, muebles y escritorios. Cerrojo de acción vertical

65

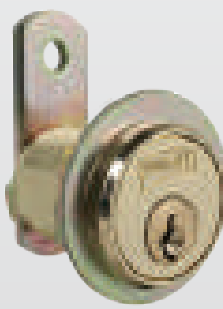

Gancho

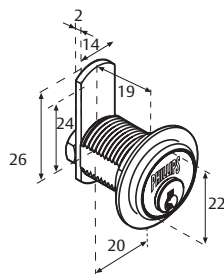

Incluyen paleta y gancho en el mismo empaque

MODELO	FUNCIÓN	EMPAQUE y MÚLTIPLO	ACABADO	SKU
65	Der. / Izq.	Caja 12 pzas.	Cromo	1238
			Latón	1240

• Para cajones, muebles y escritorios. Cerrojo de acción vertical

53

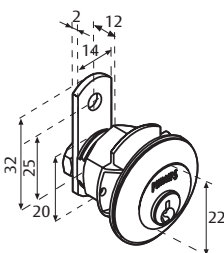

MODELO	FUNCIÓN	EMPAQUE y MÚLTIPLO	ACABADO	SKU
53	Der. / Izq.	Caja 12 pzas.	Cromo	1242

• Para cajones, muebles y escritorios. Cerrojo de acción vertical

63

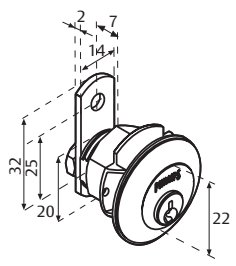

PERNOS
50

MODELO	FUNCIÓN	EMPAQUE y MÚLTIPLO	ACABADO	SKU
63	Der. / Izq.	Caja 12 pzas.	Cromo	1246

• Para cajones, muebles y escritorios. Cerrojo de acción vertical

72

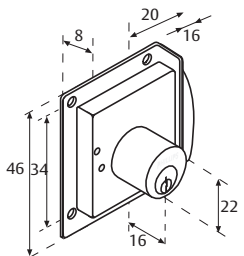

PERNOS
40

MODELO	FUNCIÓN	EMPAQUE y MÚLTIPLO	ACABADO	SKU
72	Derecha	Caja 12 pzas.	CROMO	20
	Izquierda			21
	Derecha		LATON	22
	Izquierda			23

• Para puertas corredizas derechas o izquierdas

80

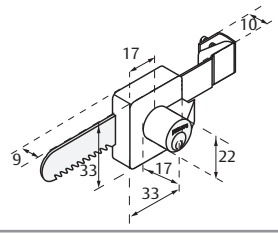

PERNOS
40

MODELO	FUNCIÓN	EMPAQUE y MÚLTIPLO	ACABADO	SKU
80	Der. / Izq.	Caja 12 pzas.	Cromo	24
80	Der. / Izq.	Skin pack 6 pzas.	Cromo	250

• Para vitrinas, aparadores y muebles con puertas corredizas

200

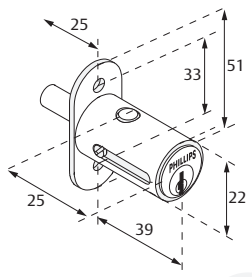
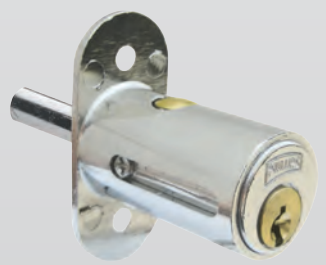

PERNOS
40

MODELO	FUNCIÓN	EMPAQUE y MÚLTIPLO	ACABADO	SKU
200	Closet	Caja 12 pzas.	Cromo	29
			Latón	30

• Para puertas corredizas de traslape

42

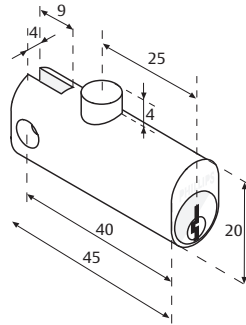
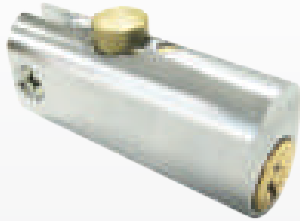

MODELO	FUNCIÓN	EMPAQUE y MÚLTIPLO	ACABADO	SKU
42	Archivero	Caja 12 pzas.	Cromo	11

• Para archiveros, cerrojo tipo botón

250

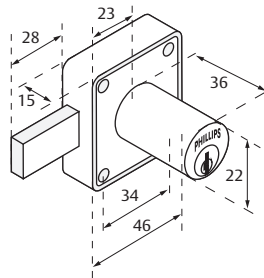

MODELO	FUNCIÓN	EMPAQUE y MÚLTIPLO	ACABADO	SKU
250	Der. / Izq.	Caja 12 pzas.	Cromo	33
			Latón	34

• Usos múltiples

250 CH

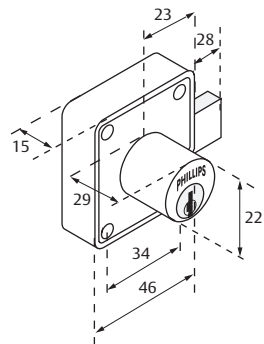

MODELO	FUNCIÓN	EMPAQUE y MÚLTIPLO	ACABADO	SKU
250 CH	Der. / Izq.	Caja 12 pzas.	Cromo	31
			Latón	32

• Usos múltiples

23

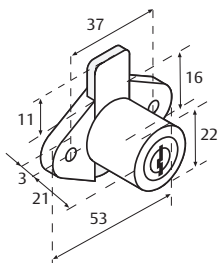

MODELO	FUNCIÓN	EMPAQUE y MÚLTIPLO	ACABADO	SKU
23	Der. / Izq.	Caja 12 pzas.	Cromo	1694
			Latón	1695

• Para cajones, muebles y escritorios. Cerrojo de acción vertical

110

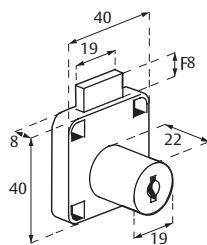

MODELO	FUNCIÓN	EMPAQUE y MÚLTIPLO	ACABADO	SKU
110	Der. / Izq.	Caja 24 pzas.	Niquel	2423

• Cerradura para usos multiples

120

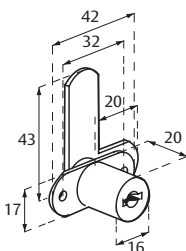

MODELO	FUNCIÓN	EMPAQUE y MÚLTIPLO	ACABADO	SKU
120	Der. / Izq.	Caja 24 pzas.	Niquel	2425

• Cerradura para muebles de oficina

130

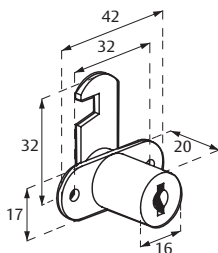

MODELO	FUNCIÓN	EMPAQUE y MÚLTIPLO	ACABADO	SKU
130	Der. / Izq.	Caja 24 pzas.	Niquel	2427

• Cerradura para muebles de oficina

170

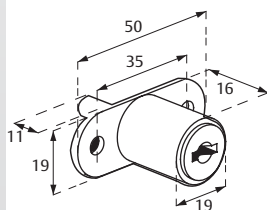

MODELO	FUNCIÓN	EMPAQUE y MÚLTIPLO	ACABADO	SKU
170	Der. / Izq.	Caja 24 pzas.	Niquel	2431

• Cerradura para puertas corredizas (closets)

180

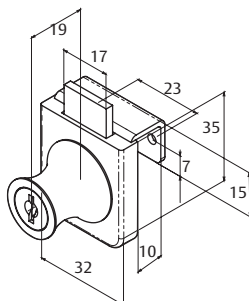

MODELO	FUNCIÓN	EMPAQUE y MÚLTIPLO	ACABADO	SKU
180	Der. / Izq.	Caja 24 pzas.	Niquel	4677

• Cerradura para puertas de cristal abatibles



ASSA ABLOY

Bisagras



BISAGRA 830



Características de bisagras

- Bisagras cuadradas
- Bisagras rectangulares
- Bisagras arquitectónicas

(Todas las medidas estan en pulgadas)

110 E / 112 E

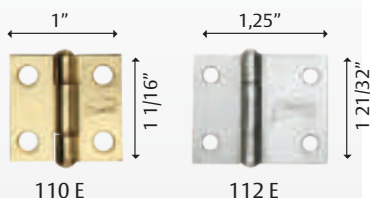

SKU	MODELO	ACABADO	PERNO	COLECTIVO	CORRUGADO
169	110E ST	Acero	Perno remachado	Caja / 20 pzas.	1200 pzas.
1343	110E CTP				
170	110E CTP	Latón			
2485	112E ST GR	Acero		A granel	1000 pzas.
2484	112E ST	Latón		Caja / 75 pzas.	900 pzas.

115 E, 120 E, 125 E

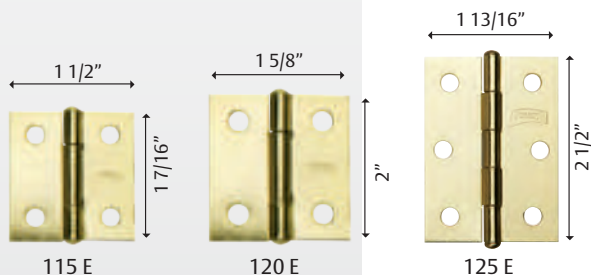

SKU	MODELO	ACABADO	PERNO	COLECTIVO	CORRUGADO
1296	115E ST GR	Acero	Perno remachado	A granel	1200 pzas.
171	115E ST				
1344	115E CTP				
172	115E CTP	Latón	Perno remachado	Caja / 20 pzas.	800 pzas.
173	120E ST	Acero			
1345	120E CTP	Latón			
175	120E CTP	Latón	Perno remachado	Caja / 10 pzas.	800 pzas.
176	125E ST	Acero			
1346	125E CTP	Latón	Perno remachado	Caja / 10 pzas.	640 pzas.
177	125E CTP	Latón			

130 E, 135 E, 140 E

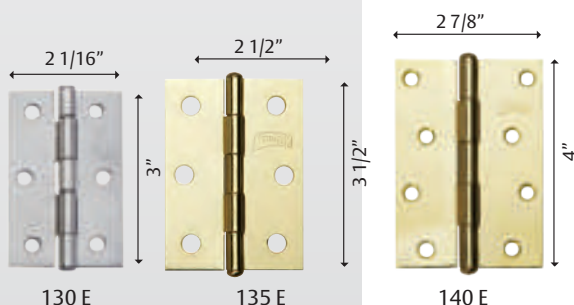

SKU	MODELO	ACABADO	PERNO	COLECTIVO	CORRUGADO
178	130E ST	Acero	Perno remachado	Caja / 20 pzas.	500 pzas.
1347	130E CTP				
179	130E CTP	Latón			
4815	130E CTP	Tipo A. Inox		Caja / 10 pzas.	190 pzas.
180	135E ST	Acero			
3383	135E CTU	Latón	Caja / 10 pzas.	180 pzas.	
182	140E ST	Acero			
3384	140E CTU	Latón			

SERIE 235 CTP

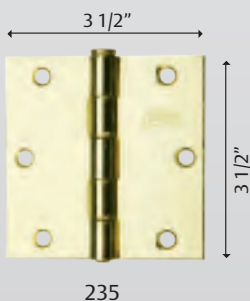

SKU	MODELO	ACABADO	PERNO	COLECTIVO	CORRUGADO
1903	235 CTP	Latón	Perno remachado	Caja / 120 pzas.	120 pzas.

BISAGRAS CUADRADAS Y RECTANGULARES

SERIE 700

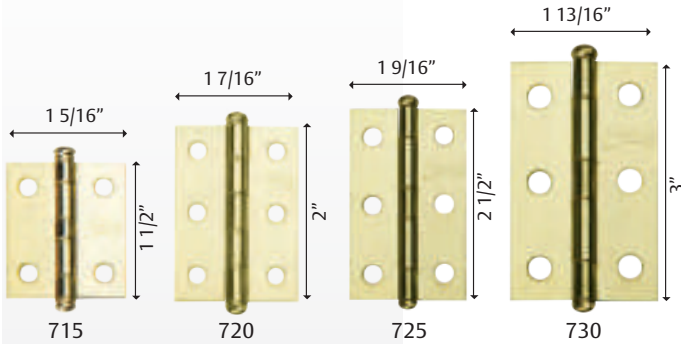

SKU	MODELO	ACABADO	PERNO	COLECTIVO	CORRUGADO
684	715 CTR	Latón	Perno suelto	Caja / 20 pzas.	1000 pzas.
212	720 CTP	Latón			800 pzas.
214	725 CTP	Latón			600 pzas.
213	725 CTP	Cobre Ant.			340 pzas.
216	730 CTP	Latón			
215	730 CTP	Cobre Ant.			

SERIE 800

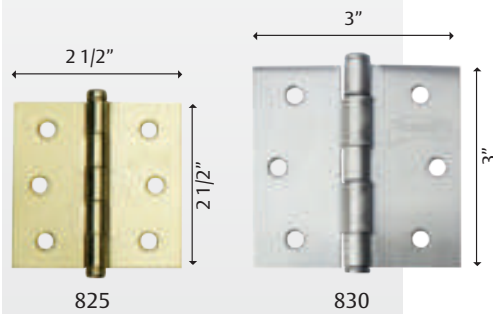

SKU	MODELO	ACABADO	PERNO	COLECTIVO	CORRUGADO
220	825 CTP	Latón	Perno suelto	Caja / 10 pzas.	200 pzas.
3388		Latón			
3387	830 CTP	Cobre Ant.			
3386		Cromo			
4814	830 CTP	Tipo A. Inox		A granel	
9690	830 ST GR	Latón			

SERIE 800 E

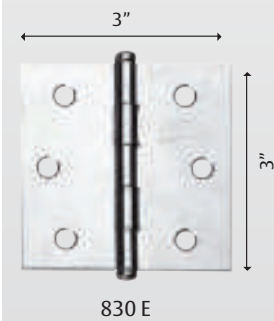

SKU	MODELO	ACABADO	PERNO	COLECTIVO	CORRUGADO
3389	830E CTP	Latón	Perno remachado	Caja / 10 pzas.	200 pzas.
224	830E ST GR	Acero		A granel	

SERIE 900

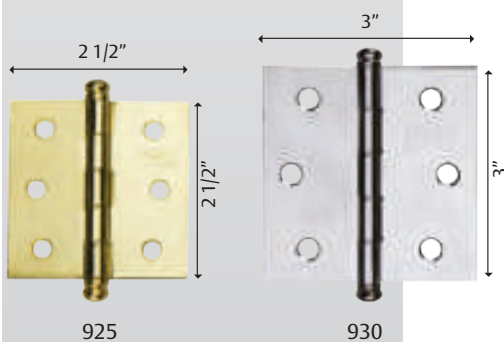

SKU	MODELO	ACABADO	PERNO	COLECTIVO	CORRUGADO
871	925 CTP	Latón	Perno suelto	Caja / 10 pzas.	240 pzas.
3392		Latón			200 pzas.
3391	930 CTP	Cobre Ant.			
3390		Cromo			
228	930 ST GR	Latón		A granel	

BISAGRAS CUADRADAS Y RECTANGULARES

SERIE 900 E

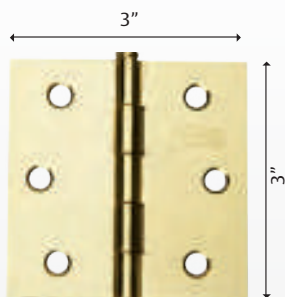

930 E

SKU	MODELO	ACABADO	PERNO	COLECTIVO	CORRUGADO
3393	930E CTP	Latón	Perno remachado	Caja / 10 pzas.	200 pzas.
230	930E ST GR	Acero		A granel	
231		Latón		A granel	

SERIE 1000

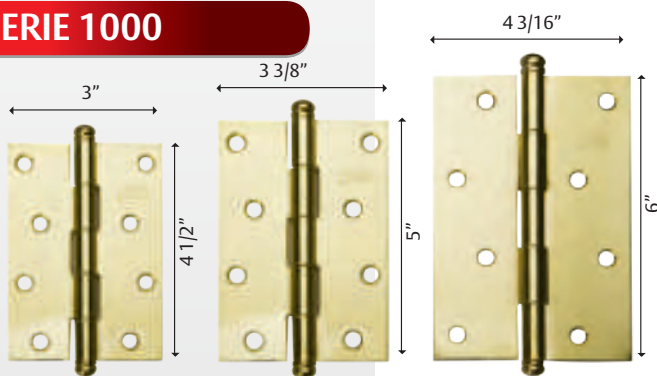

1045 L

1050 L

1060 L

SKU	MODELO	ACABADO	PERNO	COLECTIVO	CORRUGADO
3394	1045 CTP	Cobre Ant.	Perno suelto	A granel	72 pzas.
3395		Latón			
3396	1050 CTP	Latón			50 pzas.
3397	1060 CTP				

BISAGRAS ARQUITECTÓNICAS

SERIE 600

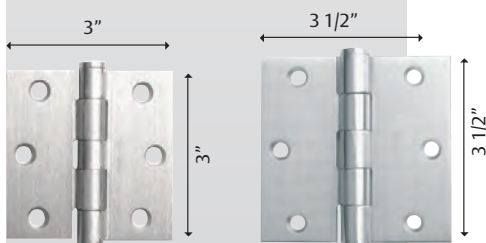

630

635

SKU	MODELO	ACABADO	ESPELOR	PERNO	COLECTIVO	CORRUGADO
2263	630	Cromo Sat	2.5 mm	Sin baleros perno suelto	Caja / 3 pzas.	36 pzas.
2277		Acero Inox.				
2335		Latón Ant.				
2264		Latón				
2265	635	Cromo Sat	3.0 mm	Sin baleros perno suelto	Caja / 3 pzas.	36 pzas.
2278		Acero Inox.				
2336		Latón Ant.				
2266		Latón				
2296		Latón Sat.				

SERIE 600

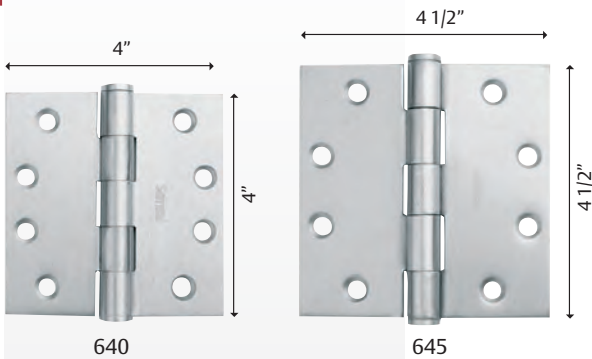

SKU	MODELO	ACABADO	ESPESOR	PERNO	COLECTIVO	CORRUGADO
2267	640	Cromo Sat	3.4 mm	Sin baleros perno suelto	Caja / 3 pzas.	36 pzas.
2279		Acero Inox.				
2337		Latón Ant.				
2268		Latón				
2269	645	Cromo Sat	3.4 mm	Sin baleros perno suelto	Caja / 3 pzas.	36 pzas.
2280		Acero Inox.				
2338		Latón Ant.				
2270		Latón				

SERIE 600 BB

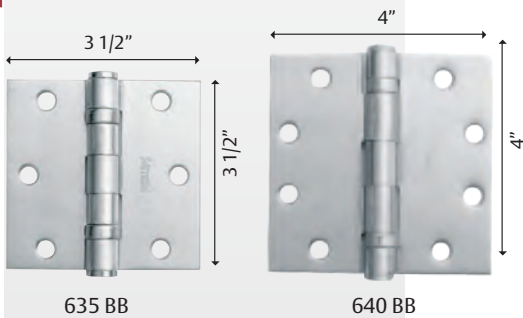

SKU	MODELO	ACABADO	ESPESOR	PERNO	COLECTIVO	CORRUGADO
2271	635 BB	Cromo Sat	2.5 mm	Con baleros perno suelto	Caja / 3 pzas.	36 pzas.
2281		Acero Inox.				
2272		Latón				
2297		Latón Sat.				
2273	640 BB	Cromo Sat	3.4 mm	Con baleros perno suelto	Caja / 3 pzas.	36 pzas.
2282		Tipo Acero Inox.				
2274		Latón				

SERIE 600 BB

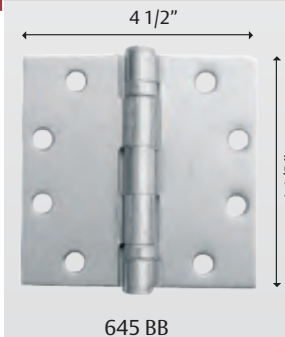

SKU	MODELO	ACABADO	ESPESOR	PERNO	COLECTIVO	CORRUGADO
2275	645 BB	Cromo Sat	3.4 mm	Con baleros perno suelto	Caja / 3 pzas.	36 pzas.
2283		Acero Inox.				
2276		Latón				

¿Cómo seleccionar el modelo de las bisagras?

- El primer dígito indica la serie a la que corresponde
600 = Bisagras arquitectónicas
- Los dos dígitos siguientes indican la altura (A) en pulgadas
030 = 3 inches

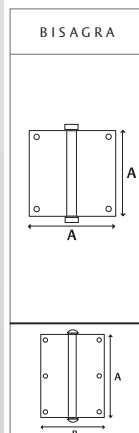

Series	Perno	A _{th}	1" 25	1.5" 38	2" 51	2.5" 64	3" 76	3.5" 89	4" 102	4.5" 114	5" 127	6" 152
SERIES 200								235				
SERIES 600							630	635	640	645		
SERIES 600BB								635BB	640BB	645BB		
SERIES 800						825	830					
SERIES 800E							830E					
SERIES 900						925	930					
SERIES 900E							930E					
SERIES 100		B	110E 11/16" 27	115E 1 7/16" 37	120E 1 5/8" 41	125E 1 13/16" 46	130E 2 1/16" 53	135E 2 1/2" 64	140E 2 7/8" 73			
SERIES 700				715 11/16" 27	720 1 5/16" 36	725 1 7/16" 36	730 1 9/16" 39					
SERIES 1000										1045 3 3/8" 86	1050 3 7/8" 96	1060 4 1/4" 106



ASSA ABLOY

Cierrapuertas y Bisagra de Piso



CIERRAPUERTAS 1402

Características de cierrapuertas

- Válvulas para ajuste de velocidad y fuerza de cierre
- Fuerza ajustable

Bisagra de piso:

- Ideal para puertas de cocinas

(Todas las medidas estan en mm)

CIERRAPUERTAS HIDRÁULICOS

1402



45 kg
500,000 ciclos

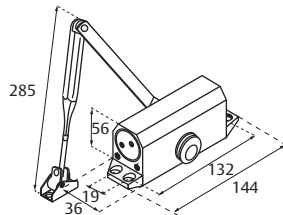

- Para de puerta de 85 a 90 cm de ancho
- Para de puerta de 45 Kg máximo
- Tránsito bajo
- 500,000 ciclos

MODELO	SKU	ACABADO	EMPAQUE y MÚLTIPLO
1402	3484	Natural	Caja 1 pza.
	3483	Blanco	
	3481	Duranodik	

- Mecanismo de ajuste de fuerza en brazo. Para puertas derechas o izquierdas

1404



80 kg
500,000 ciclos

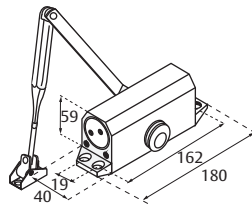

- Para puertas 80 a 120 cm de ancho
- Para de puerta de 80 Kg máximo
- Tránsito bajo
- 500,000 ciclos

MODELO	SKU	ACABADO	EMPAQUE y MÚLTIPLO
1404	443	Natural	Caja 1 pza.
	2206	Blanco	
	445	Duranodik	
1404	3482	Natural	Blister 1 pza.

- Mecanismo de ajuste de fuerza en brazo. Para puertas derechas o izquierdas

1406



80 kg
500,000 ciclos

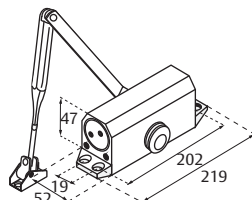

- Para puertas 80 a 120 cm de ancho
- Para de puerta de 80 Kg máximo
- Tránsito medio
- 500,000 ciclos

MODELO	SKU	ACABADO	EMPAQUE y MÚLTIPLO
1406	3480	Natural	Caja 1 pza.

- Sistema de freno hidráulico (back check). Mecanismo de ajuste de fuerza en brazo

BISAGRA1500

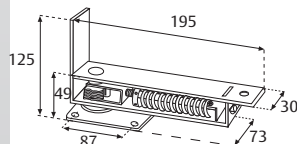
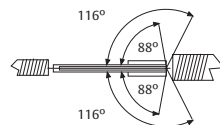

MODELO	SKU	ACABADO	EMPAQUE y MÚLTIPLO
BISAGRA 1500	1180	Latón	Caja 4 pzas.
	1220	Latón ant.	
	1179	Cromo	
	2085	Cromo sat.	
	4630	Acero inox.	
	4637	Acero inox. Satinado	

- Bisagra mecánica de piso de doble acción para puertas de vaivén, para puertas de hasta 35 Kg

Accesorios

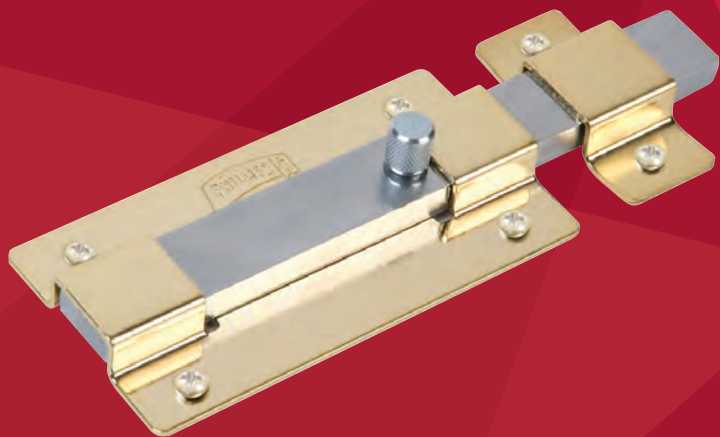

PASADORES



Características de accesorios

- Topes para piso
- Topes para pared
- Topes magnéticos
- Fijapuertas
- Accesorios de seguridad
- Pasadores
- Resbalones
- Mirillas

(Todas las medidas estan en mm)

49

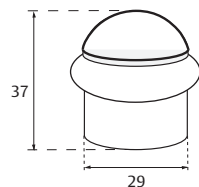

• Tope para piso con protección de hule

MODELO	EMPAQUE y MÚLTIPLO	ACABADO	SKU
TOPE 49	Caja 25 pzas.	Cromo	2624
		Cromo sat.	2625
TOPE 49	Blister 6 pzas.	Cromo	2678
		Cromo sat.	2679

54

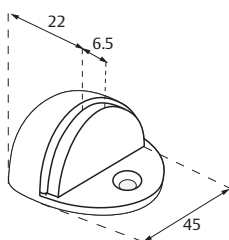

• Tope para piso con protección de hule

MODELO	EMPAQUE y MÚLTIPLO	ACABADO	SKU
TOPE 54	Caja 25 pzas.	Cromo	1464
		Cromo sat.	2071
		Latón	1462
		Latón ant	1466
TOPE 54	Blister 6 pzas.	Cromo	1465
		Cromo sat.	2218
		Latón	1463
		Latón ant.	1467

56

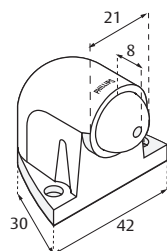

• Tope para piso con protección de hule

MODELO	EMPAQUE y MÚLTIPLO	ACABADO	SKU
TOPE 56	Caja 25 pzas.	Cromo	1045
		Cromo sat.	2072
		Latón	1044
		Latón ant	994
TOPE 56	Blister 6 pzas.	Cromo	1319
		Cromo sat.	2219
		Latón	1320
		Latón ant.	1007

57

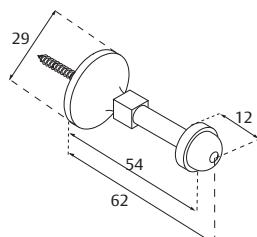

• Tope recto para pared o puerta con protección de hule

MODELO	EMPAQUE y MÚLTIPLO	ACABADO	SKU
TOPE 57	Caja 25 pzas.	Cromo	147
		Cromo sat.	2073
		Latón	148
		Latón ant	996
TOPE 57	Blister 6 pzas.	Cromo	283
		Cromo sat.	2220
		Latón	284
		Latón ant.	1009

51

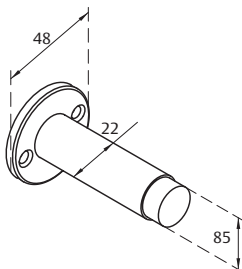

MODELO	EMPAQUE y MÚLTIPLO	ACABADO	SKU
TOPE 51	Caja 25 pzas.	Cromo	2628
		Cromo sat.	2629

- Tope recto para pared o puerta con protección de hule

1054

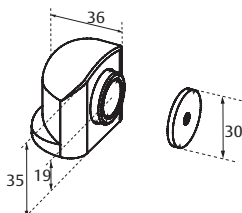

MODELO	EMPAQUE y MÚLTIPLO	ACABADO	SKU
TOPE 1054	Blister 6 pzas.	Cromo	3173
		Latón ant.	3172
		Niquel sat.	3174

- Tope fijapuertas magnético

1057

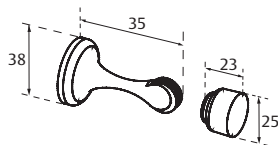

MODELO	EMPAQUE y MÚLTIPLO	ACABADO	SKU
TOPE 1057	Blister 6 pzas.	Cromo	3177
		Niquel sat.	3178
		Latón ant.	3176

- Tope fijapuertas magnético

58

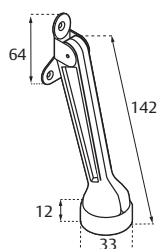

MODELO	EMPAQUE y MÚLTIPLO	ACABADO	SKU
FIJA-PUERTAS 58	Blister 6 pzas.	Cromo	149
		Latón	150
		Latón ant.	998
	Blister 15 pzas	Cromo	285

- Fijapuertas robusto con goma antiderrapante, instalado desde el interior actua como palanca auxiliar

59

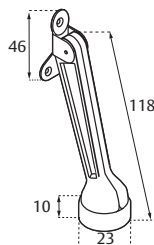

MODELO	EMPAQUE y MÚLTIPLO	ACABADO	SKU
FIJAPUERTA 59	Caja 6 pzas.	Cromo	1222
		Latón	1223
		Latón ant.	1224
		Cromo sat.	2075
FIJAPUERTA 59	Blister 6 pzas.	Cromo	1415
		Latón	1414
		Cromo sat.	2221
		Latón ant.	1416

• Fijapuertas robusto con goma antiderrapante, instalado desde el interior actua como palanca auxiliar

44

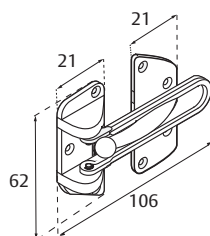

MODELO	EMPAQUE y MÚLTIPLO	ACABADO	SKU
44	Caja 6 pzas.	Cromo	1000
		Cromo sat.	2076
		Latón	1001
		Latón ant.	1002
44	Blister 6 pzas.	Cromo	140
		Cromo sat.	2222
		Latón	141

• Accesorio de seguridad ideal para puertas de hotel, casa y oficina

48

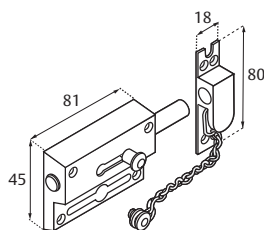

MODELO	EMPAQUE y MÚLTIPLO	ACABADO	SKU
48	Caja 6 pzas.	Cromo	572
		Cromo sat.	2077
		Latón	573
		Latón ant.	607
48	Blister 6 pzas.	Cromo	899
		Cromo sat.	2223
		Latón	900

• Pasador de acero sólido con cadena de seguridad adicional.

31 CH

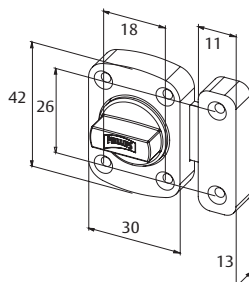

MODELO	EMPAQUE y MÚLTIPLO	ACABADO	SKU
31 CH	Caja 20 pzas.	Cromo	2604
31 CH	Blister 20 pzas.	Cromo	2077

• Pasador de sobrepone, puede colocarse horizontal o verticalmente

31

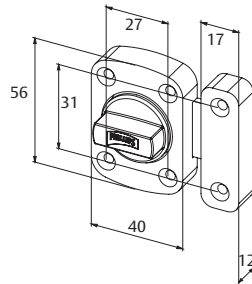

MODELO	EMPAQUE y MÚLTIPLO	ACABADO	SKU
31	Caja 20 pzas.	Cromo	2603
31	Blister 20 pzas.	Cromo	2676

- Pasador de sobreponer, puede colocarse horizontal o verticalmente

35

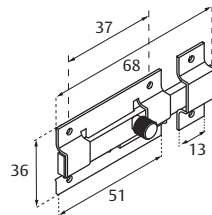

MODELO	EMPAQUE y MÚLTIPLO	ACABADO	SKU
35	Caja 12 pzas.	Cromo	132
		Cromo sat.	2078
		Latón	379
		Latón ant.	990
35	Skin Pack 36 pzas.	Latón	383
		Latón ant.	1003
35	Skin Pack 3 pzas.	Cromo	275

- Pasador de sobreponer, puede colocarse horizontal o verticalmente. Incluye botón de seguridad

36

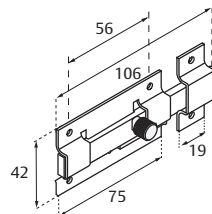
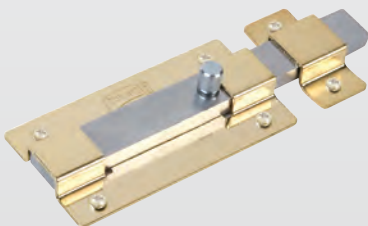

MODELO	EMPAQUE y MÚLTIPLO	ACABADO	SKU
36	Caja 6 pzas.	Cromo	133
		Cromo sat.	2079
		Latón	380
		Latón ant.	991
36	Skin Pack 24 pzas.	Cromo	276
		Latón	384
		Latón ant.	1004

- Pasador de sobreponer, puede colocarse horizontal o verticalmente. Incluye botón de seguridad

37

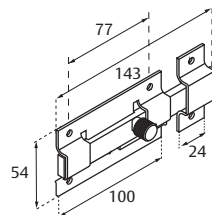
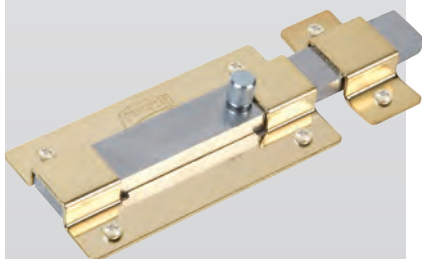

MODELO	EMPAQUE y MÚLTIPLO	ACABADO	SKU
37	Caja 6 pzas.	Cromo	134
		Cromo sat.	2080
		Latón	381
		Latón ant.	992
37	Skin Pack 20 pzas.	Cromo	277
		Latón	385
		Latón ant.	1005

- Pasador de sobreponer, puede colocarse horizontal o verticalmente. Incluye botón de seguridad

38

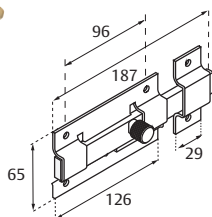
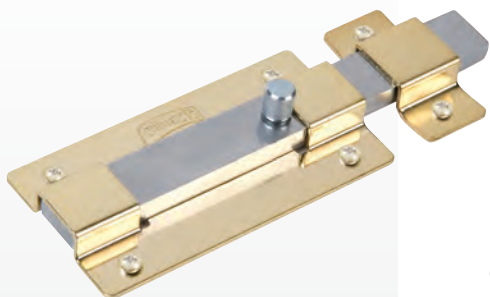

MODELO	EMPAQUE y MÚLTIPLO	ACABADO	SKU
38	Caja 6 pzas.	Cromo	135
		Cromo sat.	2081
		Latón	382
		Latón ant.	993
38	Skin Pack 15 pzas.	Cromo	278
		Latón	386

- Pasador de sobreponer, puede colocarse horizontal o verticalmente. Incluye botón de seguridad

45

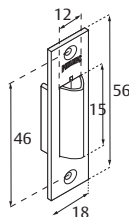

MODELO	EMPAQUE y MÚLTIPLO	ACABADO	SKU
45	Caja 50 pzas.	Cromo	142

- Resbalones para puertas de vaiven

46

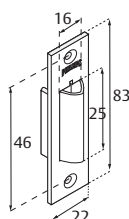

MODELO	EMPAQUE y MÚLTIPLO	ACABADO	SKU
46	Caja 50 pzas.	Cromo	143

- Resbalones para puertas de vaiven

MIRILLAS

180° y 200°

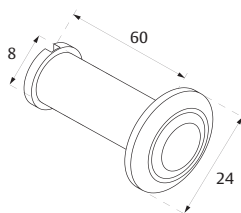

MODELO	EMPAQUE y MÚLTIPLO	ACABADO	SKU
1618 180°	Caja 24 pzas.	Cromo	3025
		Latón	3026
		Latón ant.	3027
1620 200°	Caja 24 pzas.	Cromo	3028
		Latón	3029
		Latón ant.	3030

- Ideal para puertas de 35 a 45 mm



“Te invitamos a formar parte del Club de instaladores ASSA ABLOY”



i Aprende o reafirma tus conocimientos en instalación de productos ASSA ABLOY **!**



¿Qué es el Club de Instaladores?

Se integra por personas que se capacitan constantemente con el fin de reforzar su formación en el campo de la seguridad.

Contacto:
Tel: 01 800 7028 900 LADA sin costo
Tel: (55) 2122 0526 al 31 ventas comerciales

Regístrate a través de estos medios:

servicio_clientes@assaabloy.com
<http://eepurl.com/b8JCPj>



Síguenos en:
Club de Instaladores de ASSA ABLOY México

Síguenos en REDES SOCIALES



ASSA ABLOY México

Cerraduras Phillips MX

Yale Mx

Tesa Mx

Medeco Mx



ASSA ABLOY



@ASSAABLOYMéxico

@PHILLIPSMéxico

@YALEMéxico

@TESAMéxico

@MEDECOMéxico



• www.assaabloy.com.mx

• www.phillips.com.mx

• www.yalemexico.com

• www.tesa.com.mx

ASSA ABLOY

The global leader in door opening solutions

Dirección fiscal y planta:

Pelicano 242 Col. Granjas Modernas
C. P. 07460 México, D. F.

Teléfonos y fax:

01 (55) 5518 0000 conmutador
01 (55) 2122 0500 comercial
01 (55) 2122 0549 fax oficinas comerciales
01 (55) 2122 0526 al 31 ventas oficinas comerciales
01 800 7028 900 LADA sin costo

Exportaciones:

01 (55) 2122 0504 / 95

Correo electrónico:

servicio.clientes@assaabloy.com

Fecha de impresión:

Enero 2017

